



EMM5078ZV

C-Band Power Amplifier MMIC

FEATURES

- Output Power; P1dB = 26 dBm (Typ.)
- High Gain; GL = 30 dB(Typ.)
- Wide Frequency Band ; 3.4 – 8.5 GHz
- Impedance Matched Zin/Zout = 50Ω
- QFN 24pin Plastic Mold Package(ZV)

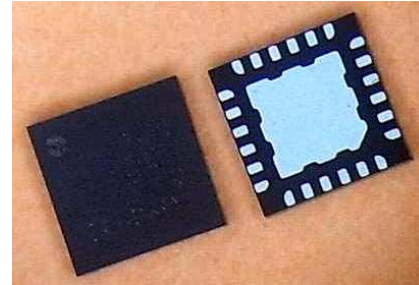

DESCRIPTION

The EMM5078ZV is a wide band power amplifier MMIC that contains a three stage amplifier, internally matched, for standard communications band in 3.4 to 8.5GHz frequency range. SEDI's stringent Quality Assurance Program assures the highest reliability and consistent performance.

ABSOLUTE MAXIMUM RATING

Item	Symbol	Rating	Unit
Drain-Source Voltage	V _{DD}	10	V
Gate-Source Voltage	V _{GG}	-3	V
Input Power	P _{in}	22	dBm
Storage Temperature	T _{stg}	-55 to +125	°C

RECOMMENDED OPERATING CONDITIONS

Item	Symbol	Condition	Unit
Drain-Source Voltage	V _{DD}	<=6	V
Input Power	P _{in}	<=2	dBm
Operating Backside Temperature	Top	-40 to +85	°C

ELECTRICAL CHARACTERISTICS (Case Temperature Tc=25°C)

Item	Symbol	Test Conditions	Limits			Unit
			Min.	Typ.	Max.	
Frequency Range	f	V _{DD} =6V	3.4	-	8.5	GHz
Output Power at 1dB G.C.P.	P _{1dB}	I _{DD} (DC)=300mA typ.	23	26	-	dBm
Power Gain at 1dB G.C.P.	G _{1dB}	Zs=Zl=50ohm	24	29	-	dB
Power-added Efficiency at 1dB G.C.P.	η _{add}		-	18	-	%
Third Order Intermodulation*	IM ₃	*:Δf=10MHz ,	-35	-40	-	dBc
Drain Current at 1dB G.C.P.	IDD	2-Tone Test,	-	350	450	mA
Input Return Loss (at Pin=-20dBm)	RL _{in}	Pout=15dBm S.C.L.	-	-10	-	dB
Output Return Loss (at Pin=-20dBm)	RL _{out}		-	-10	-	dB

G.C.P.:Gain Compression Point, S.C.L.:Single Carrier Level

ESD	Class 0	=< 250V
------------	----------------	-------------------

Note : Based on JEDEC JESD22-A114C (C=100pF, R=1.5kohm)

CASE STYLE	ZV
-------------------	-----------

MSL	3
------------	----------

Note : Based on IPC/JEDEC J-STD-020C

RoHs Compliance	Yes
------------------------	------------

ORDERING INFORMATION

Part Number	Order Unit	Packing
EMM5078ZV	No Limitation	490 pcs/Tray X 10 Trays=4900pcs/Packing
EMM5078ZVT	500 pcs	500 pcs./Reel x 1 Reel=500 pcs./Pack



EMM5078ZV

C-Band Power Amplifier MMIC

Output Power vs. Frequency

@VDD=6V, IDD(DC)=300mA

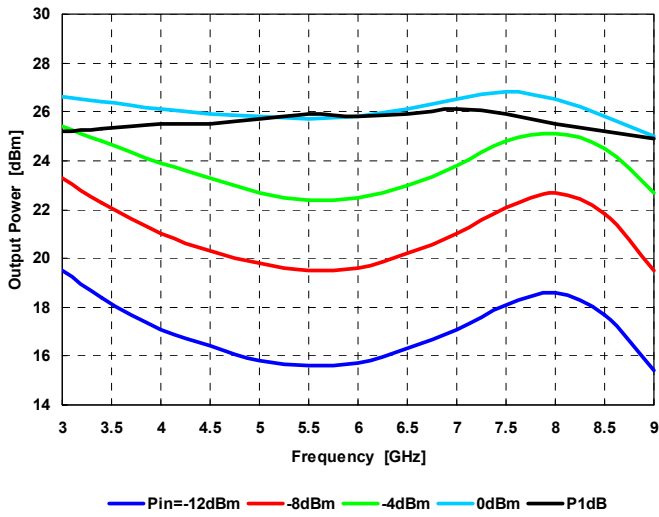

Output Power, Drain Current vs. Input Power

@VDD=6V, IDD(DC)=300mA

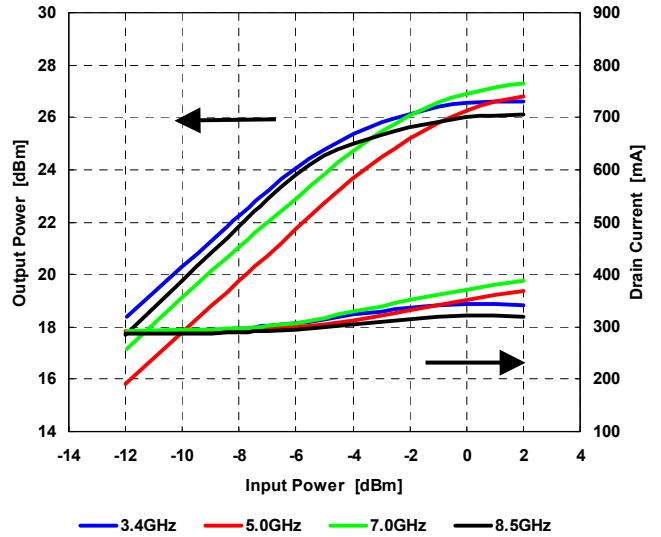

Power Added Efficiency vs. Frequency

@VDD=6V, IDD(DC)=300mA

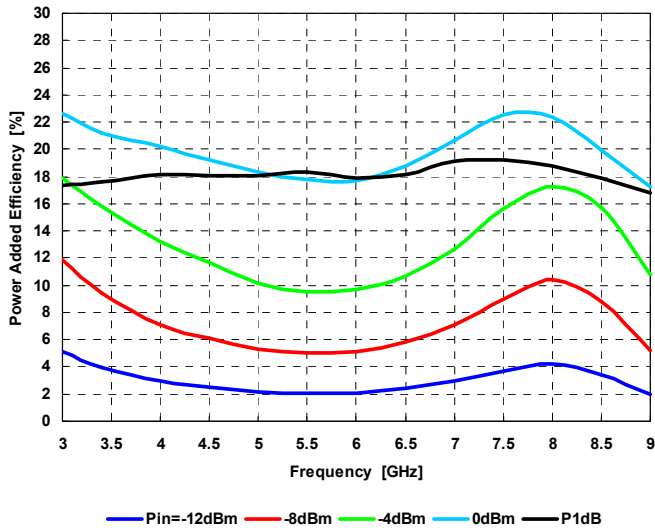

IMD vs. Output Power

@VDD=6V, IDD(DC)=300mA

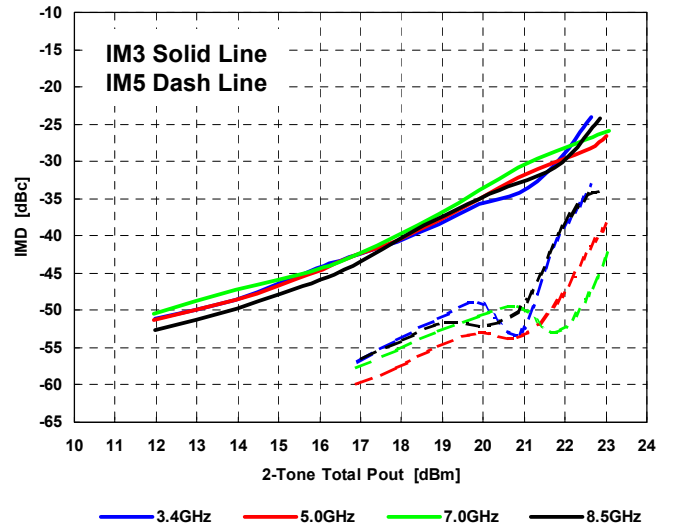



EMM5078ZV

C-Band Power Amplifier MMIC

IM3 vs. Frequency

@VDD=6V, IDD(DC)=300mA, @Po=15dBm S.C.L.

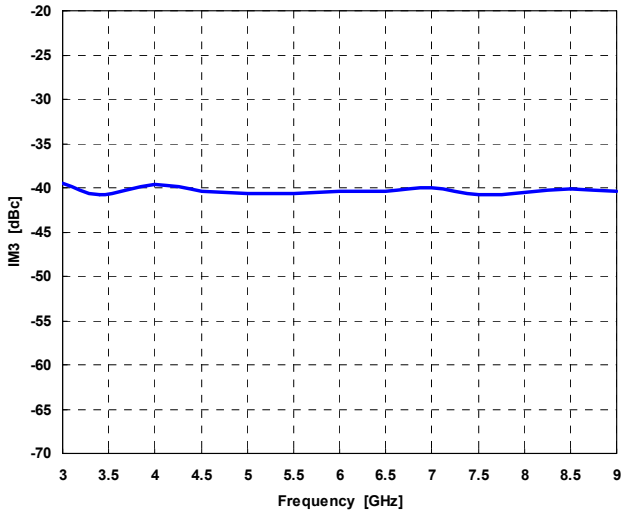

P1dB, G1dB vs. Frequency by Drain Voltage

@IDD(DC)=300mA

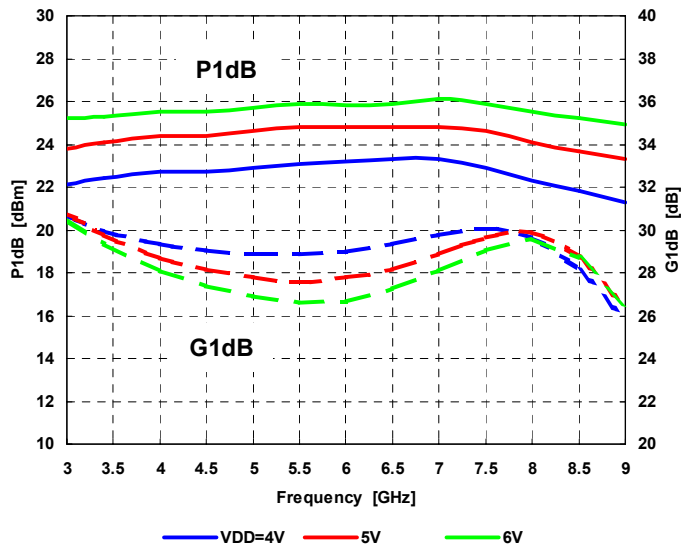

P1dB, G1dB vs. Frequency by Drain Current

@VDD=6V

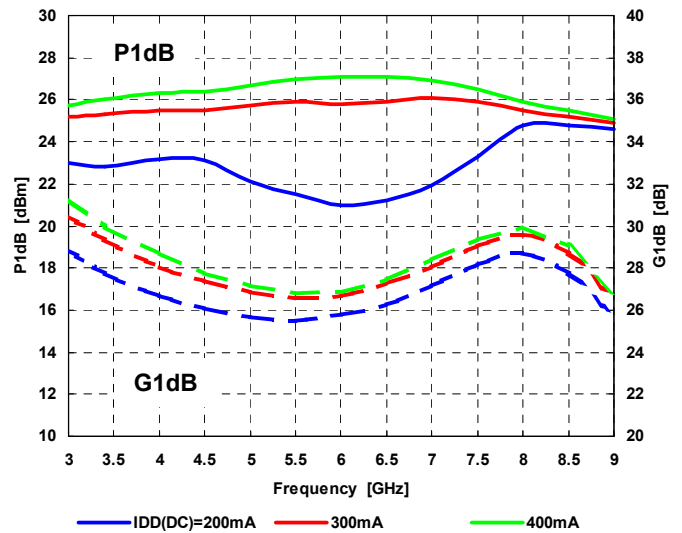



EMM5078ZV

C-Band Power Amplifier MMIC

Output Power, Drain Current vs. Input Power by Drain Voltage

@f=3.4GHz, IDD(DC)=300mA

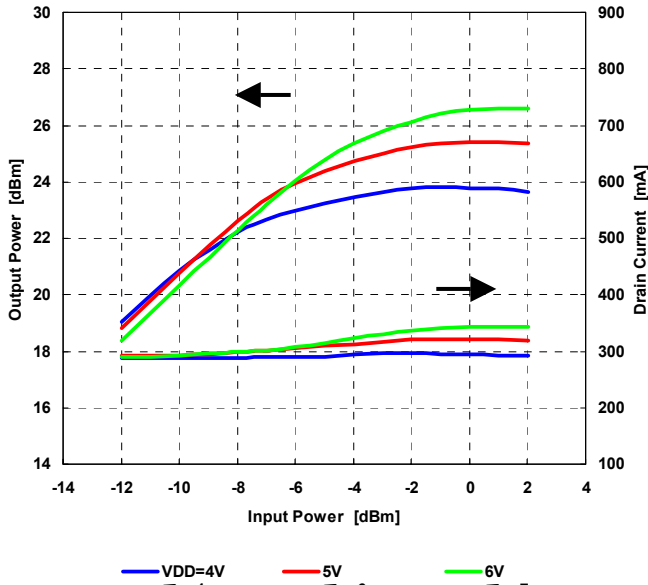

Output Power, Drain Current vs. Input Power by Drain Voltage

@f=5.0GHz, IDD(DC)=300mA

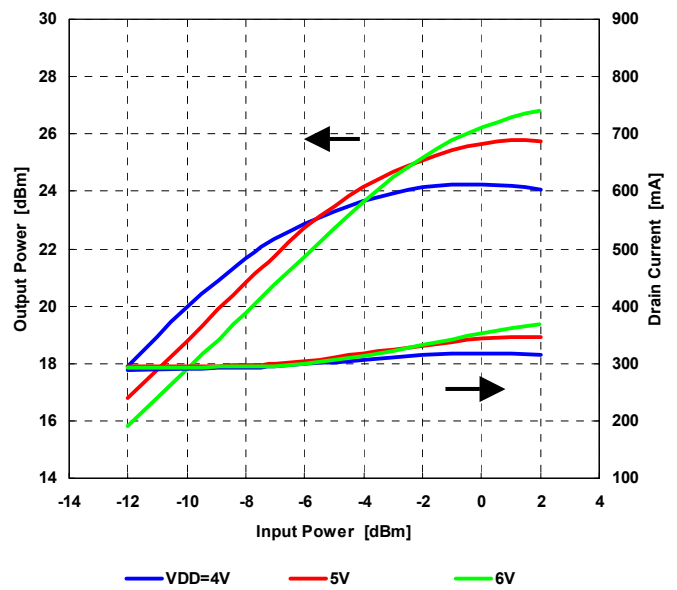

Output Power, Drain Current vs. Input Power by Drain Voltage

@f=7.0GHz, IDD(DC)=300mA

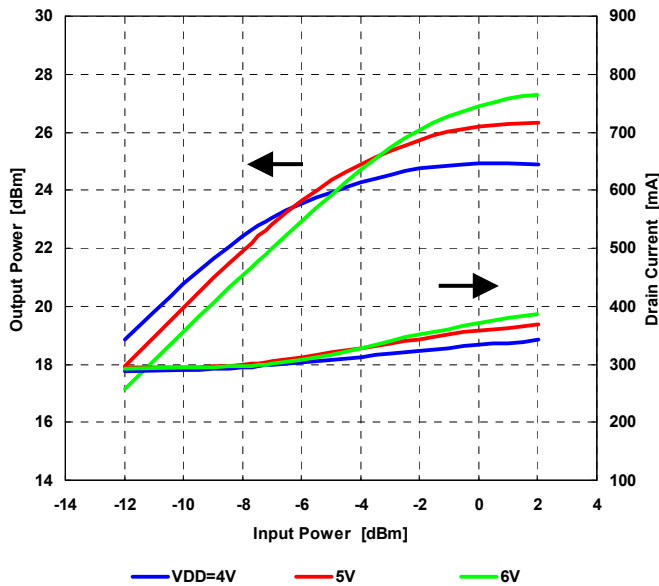

Output Power, Drain Current vs. Input Power by Drain Voltage

@f=8.5GHz, IDD(DC)=300mA

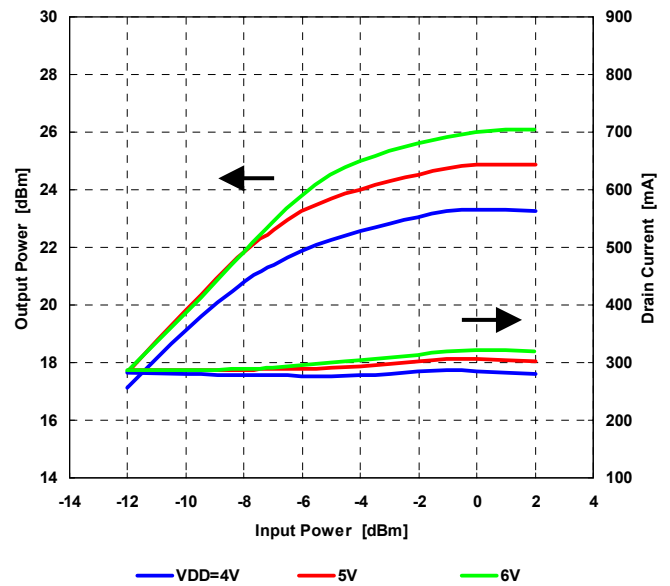



EMM5078ZV

C-Band Power Amplifier MMIC

Output Power, Drain Current vs. Input Power by Drain Current

@f=3.4GHz, VDD=6V

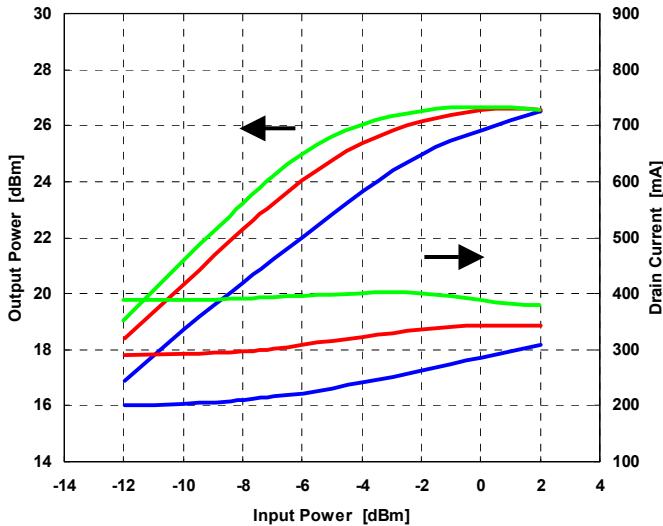

— IDD(DC)=200mA — 300mA — 400mA

Output Power, Drain Current vs. Input Power by Drain Current

@f=5.0GHz, VDD=6V

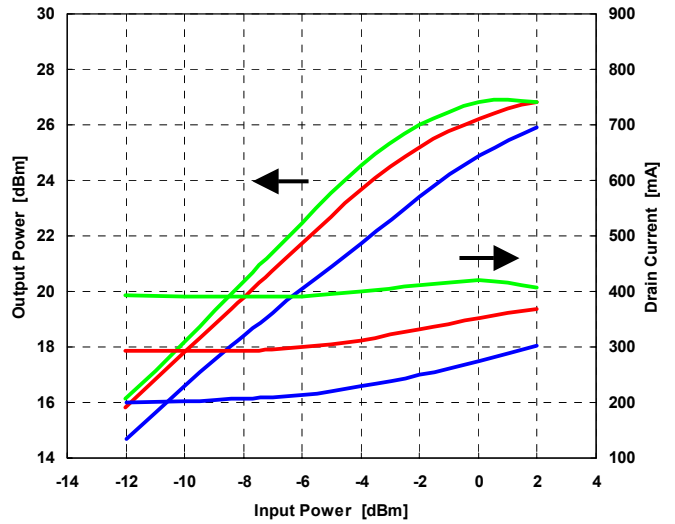

— IDD(DC)=200mA — 300mA — 400mA

Output Power, Drain Current vs. Input Power by Drain Current

@f=7.0GHz, VDD=6V

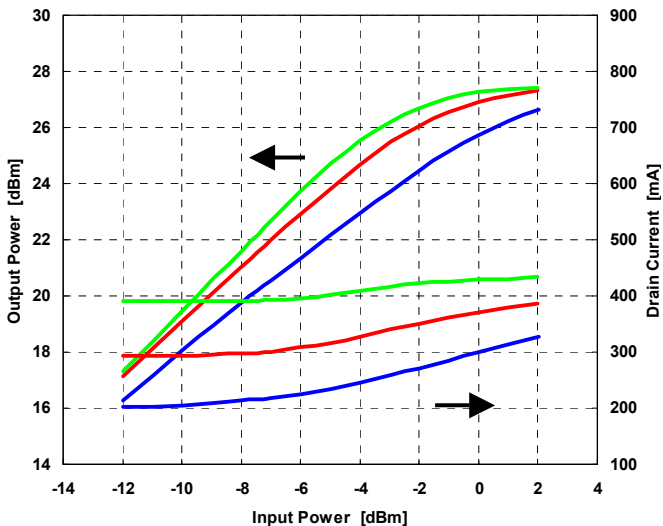

— IDD(DC)=200mA — 300mA — 400mA

Output Power, Drain Current vs. Input Power by Drain Current

@f=8.5GHz, VDD=6V

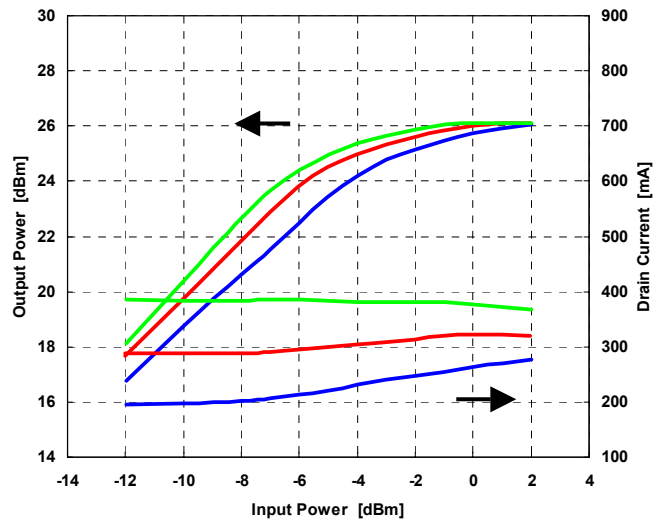

— IDD(DC)=200mA — 300mA — 400mA



EMM5078ZV

C-Band Power Amplifier MMIC

IMD Performance vs. Output Power by Drain Voltage

@f=3.4GHz, IDD(DC)=300mA

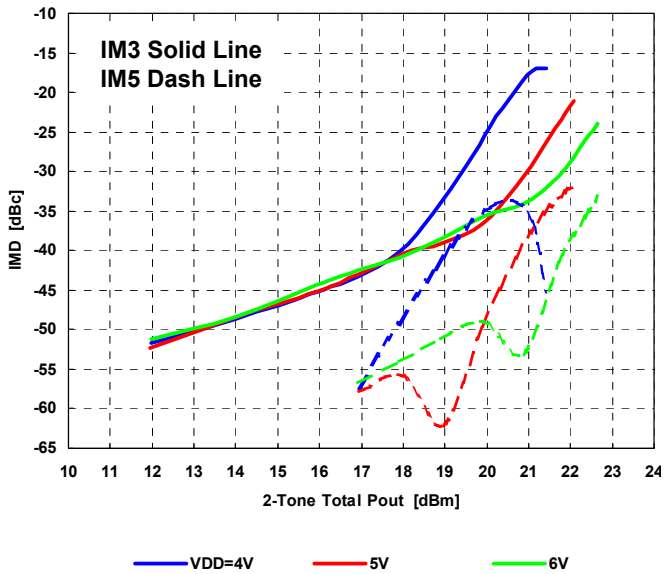

IMD Performance vs. Output Power by Drain Voltage

@f=5.0GHz, IDD(DC)=300mA

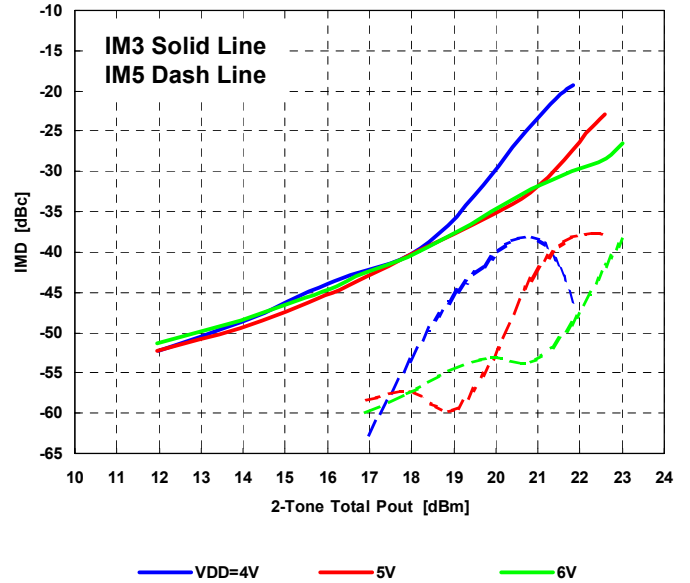

IMD Performance vs. Output Power by Drain Voltage

@f=7.0GHz, IDD(DC)=300mA

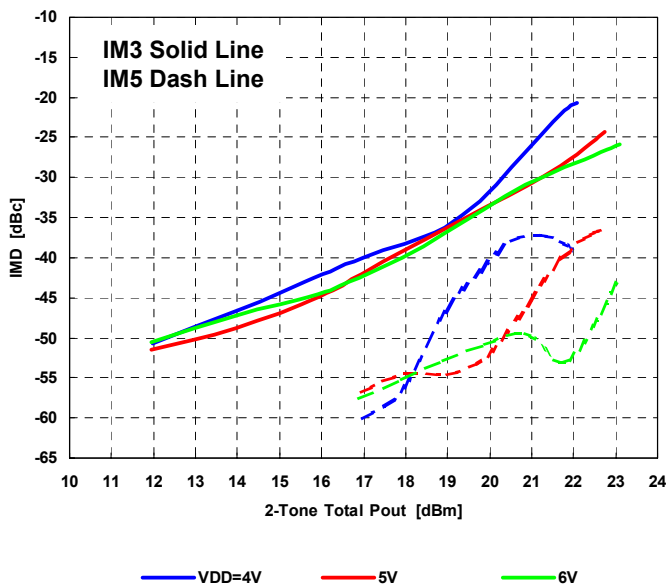

IMD Performance vs. Output Power by Drain Voltage

@f=8.5GHz, IDD(DC)=300mA

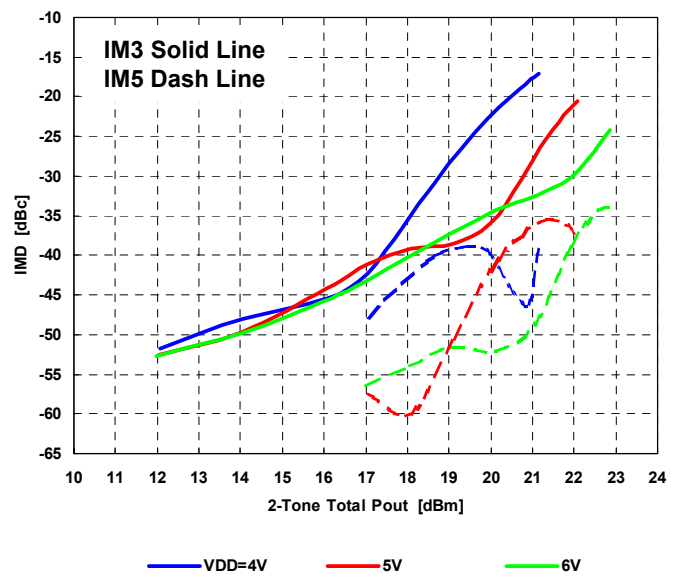



EMM5078ZV

C-Band Power Amplifier MMIC

IMD Performance vs. Output Power by Drain Current

@f=3.4GHz, VDD=6V

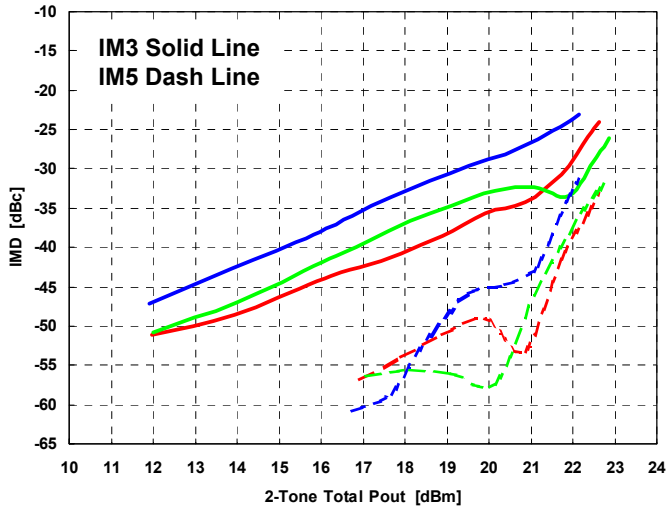

— IDD(DC)=200mA — 300mA — 400mA

IMD Performance vs. Output Power by Drain Current

@f=5.0GHz, VDD=6V

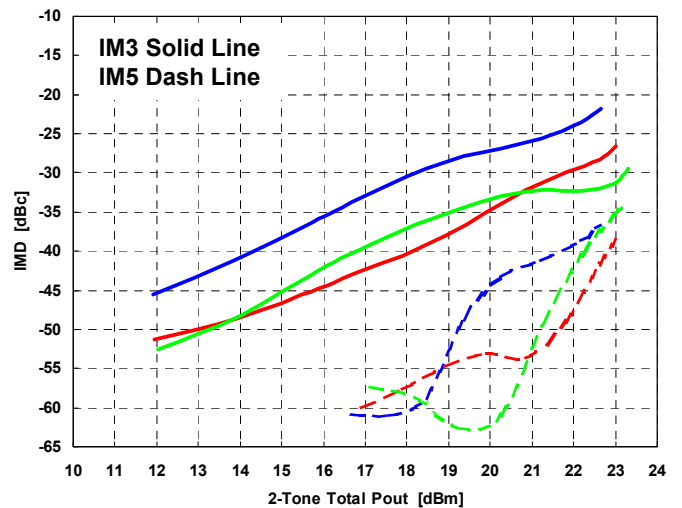

— IDD(DC)=200mA — 300mA — 400mA

IMD Performance vs. Output Power by Drain Current

@f=7.0GHz, VDD=6V

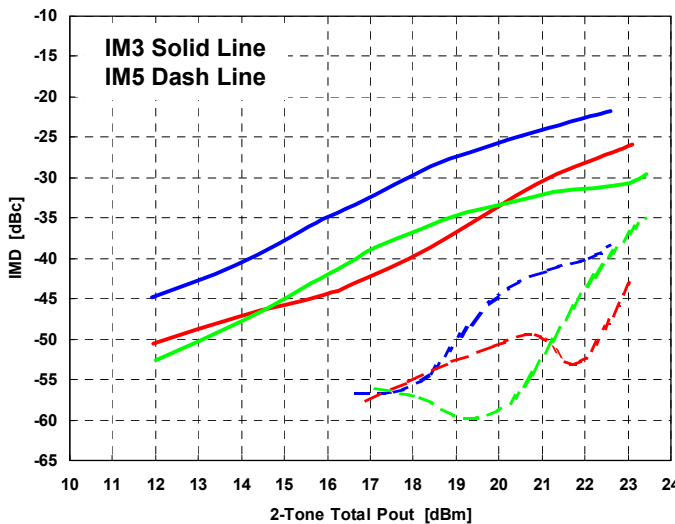

— IDD(DC)=200mA — 300mA — 400mA

IMD Performance vs. Output Power by Drain Current

@f=8.5GHz, VDD=6V

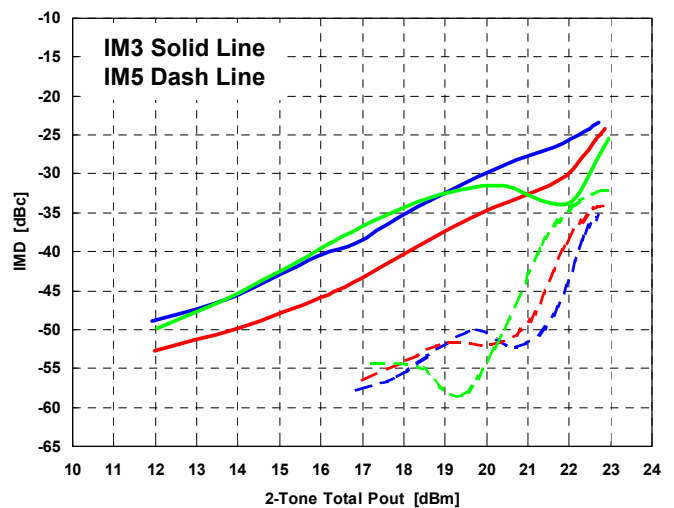

— IDD(DC)=200mA — 300mA — 400mA



EMM5078ZV

C-Band Power Amplifier MMIC

Output Power, Drain Current vs. Input Power by Temperature

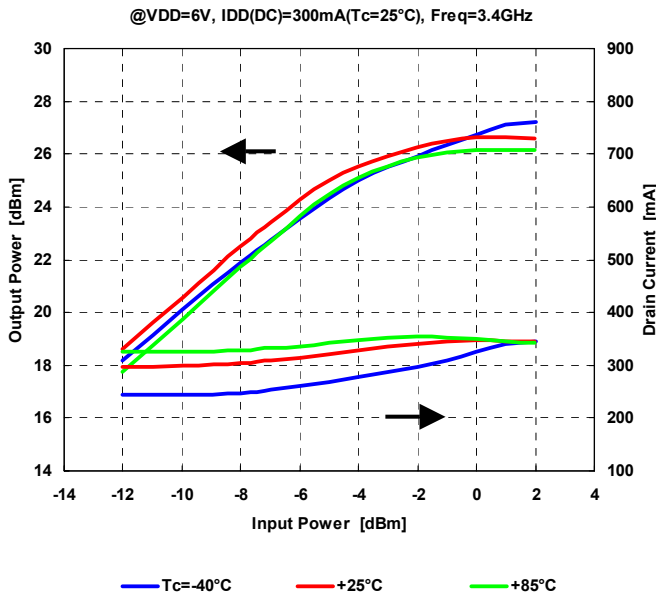

Output Power, Drain Current vs. Input Power by Temperature

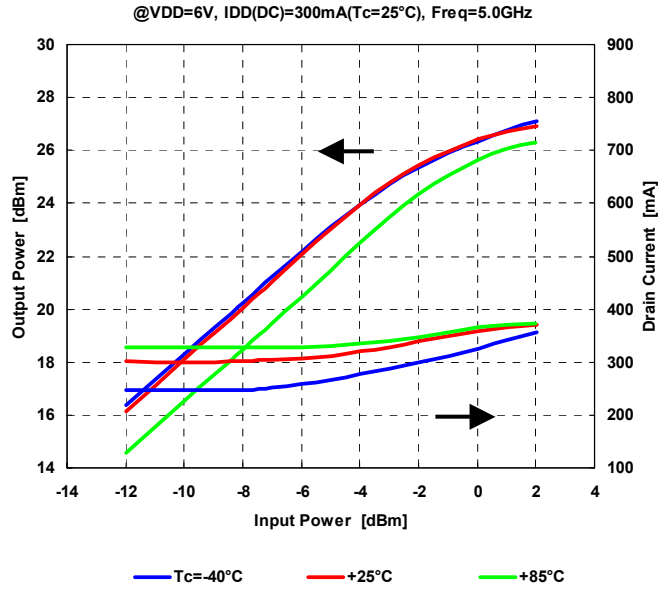

Output Power, Drain Current vs. Input Power by Temperature

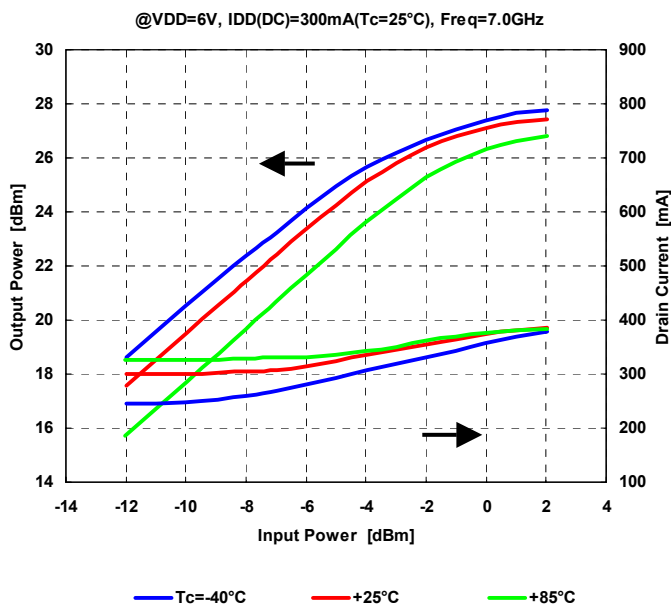

Output Power, Drain Current vs. Input Power by Temperature

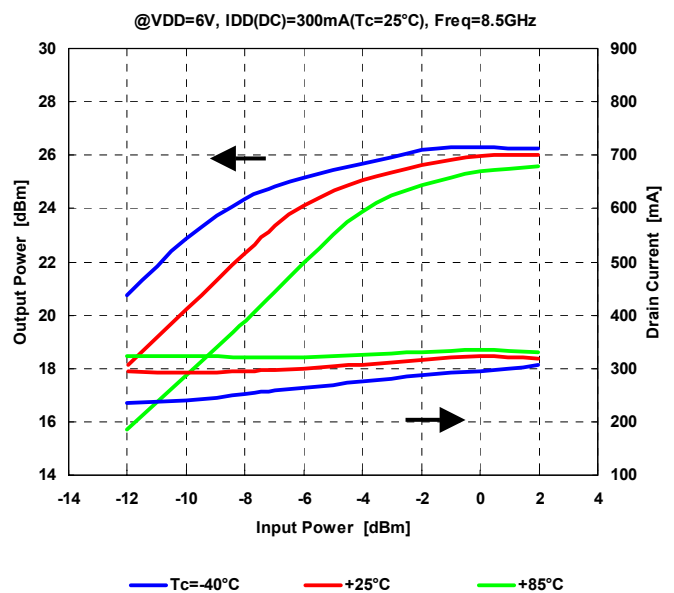



EMM5078ZV

C-Band Power Amplifier MMIC

IMD Performance vs. Output Power by Temperature

@VDD=6V, IDD(DC)=300mA(Tc=25°C), Freq=3.4GHz

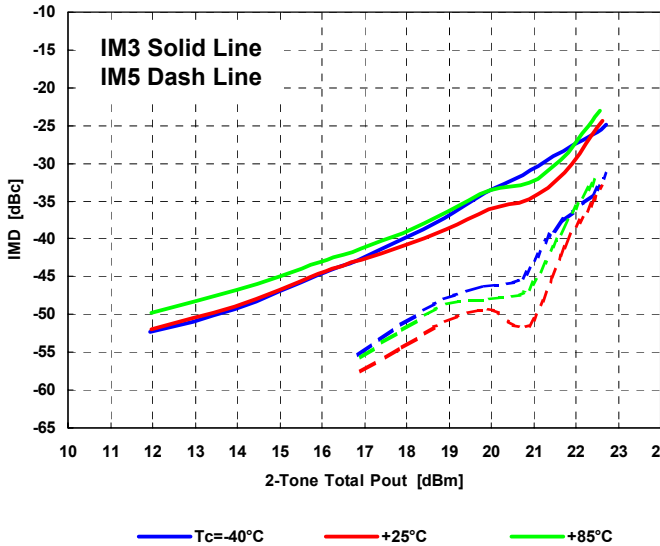

IMD Performance vs. Output Power by Temperature

@VDD=6V, IDD(DC)=300mA(Tc=25°C), Freq=5.0GHz

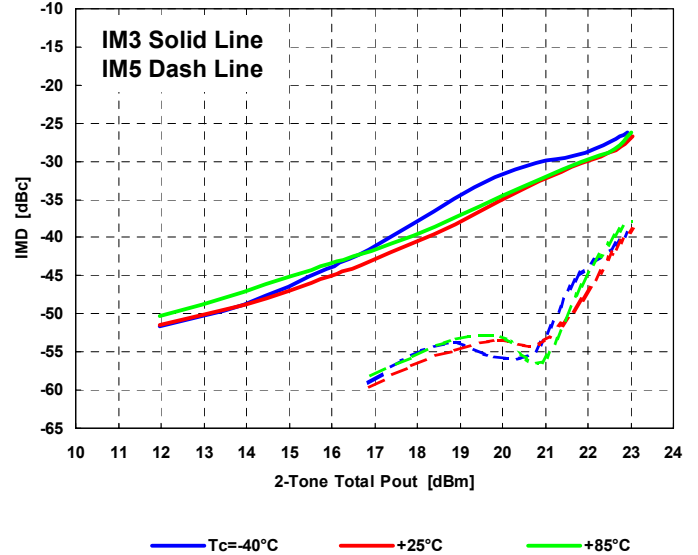

IMD Performance vs. Output Power by Temperature

@VDD=6V, IDD(DC)=300mA(Tc=25°C), Freq=7.0GHz

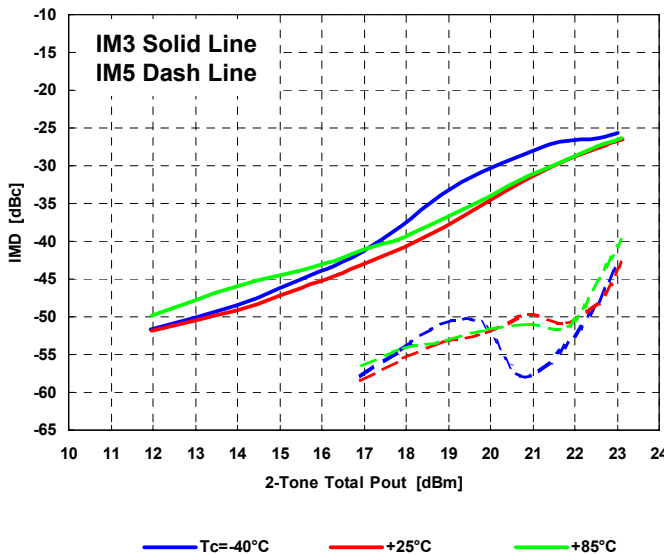

IMD Performance vs. Output Power by Temperature

@VDD=6V, IDD(DC)=300mA(Tc=25°C), Freq=8.5GHz

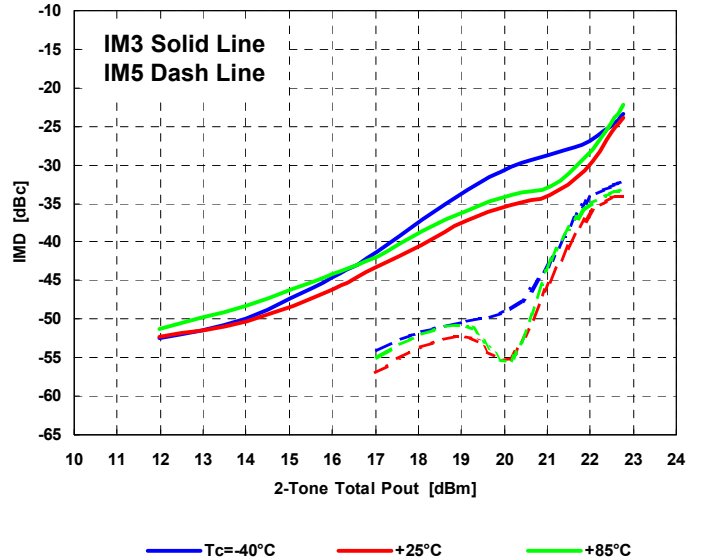



EMM5078ZV

C-Band Power Amplifier MMIC

S-PARAMETERS

@VDD=6V, IDD=300mA

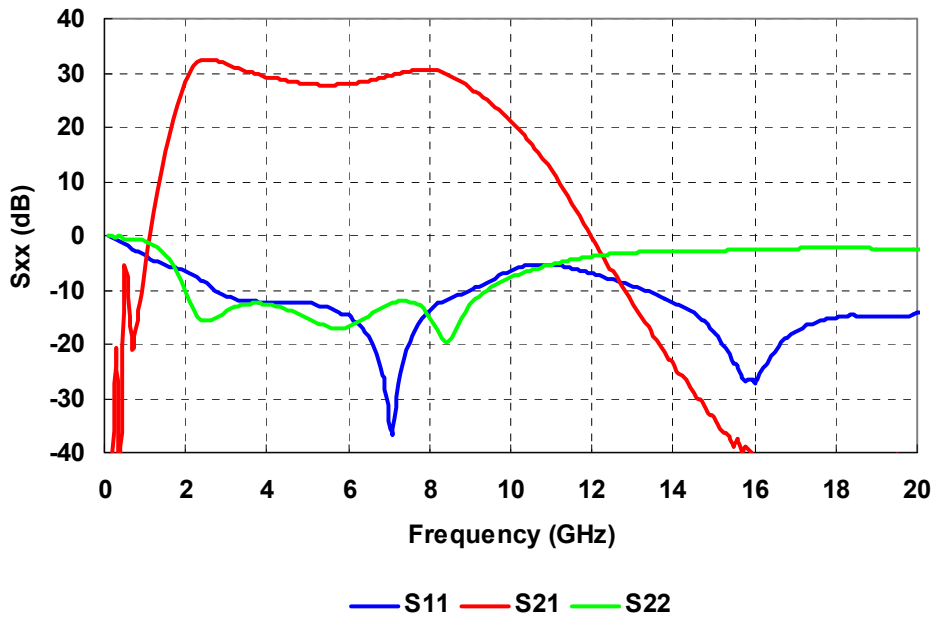

@VDD=6V, IDD=300mA

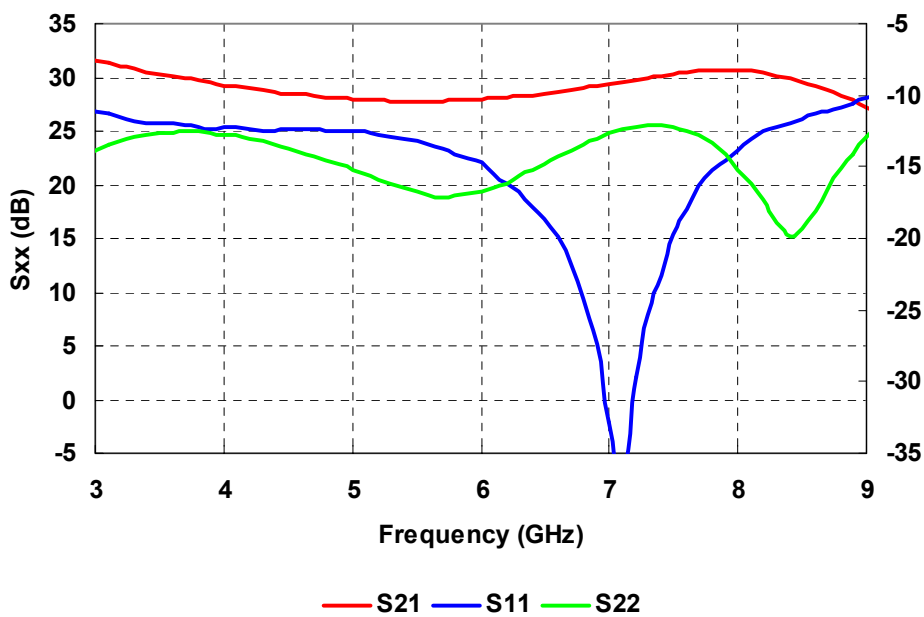



EMM5078ZV

C-Band Power Amplifier MMIC

■ Package Outline and Pin Assignment

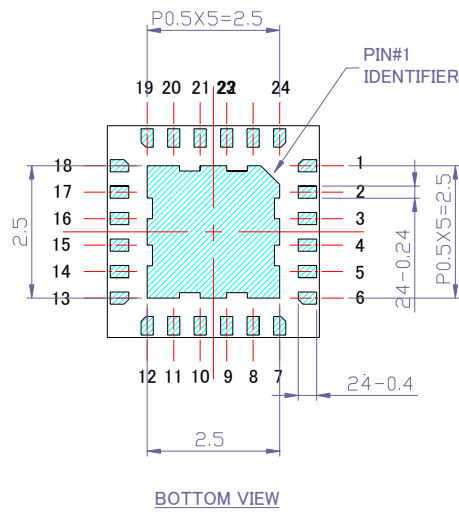
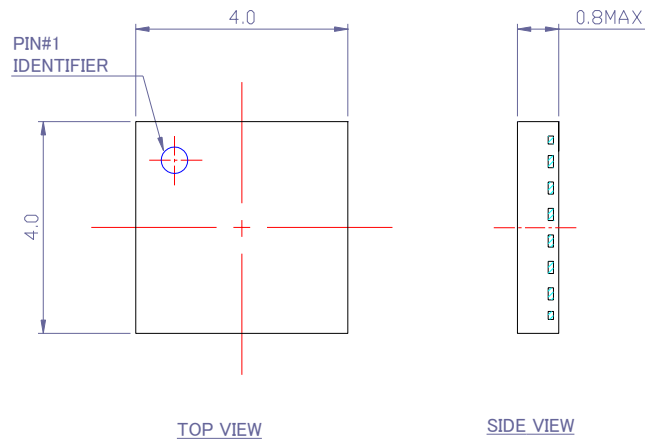

PIN Assignment

RF IN : 3,4

RF OUT : 15,16

VGG1 : 24

VDD1 : 7

VGG2 : 22

VDD2 : 9

VGG3 : 20

VDD3 : 11

N/C : 1,2,5,6,8,10,12,13,14,17,18,19,21,23

Unit : mm

■ PCB Pads and Solder-resist Pattern

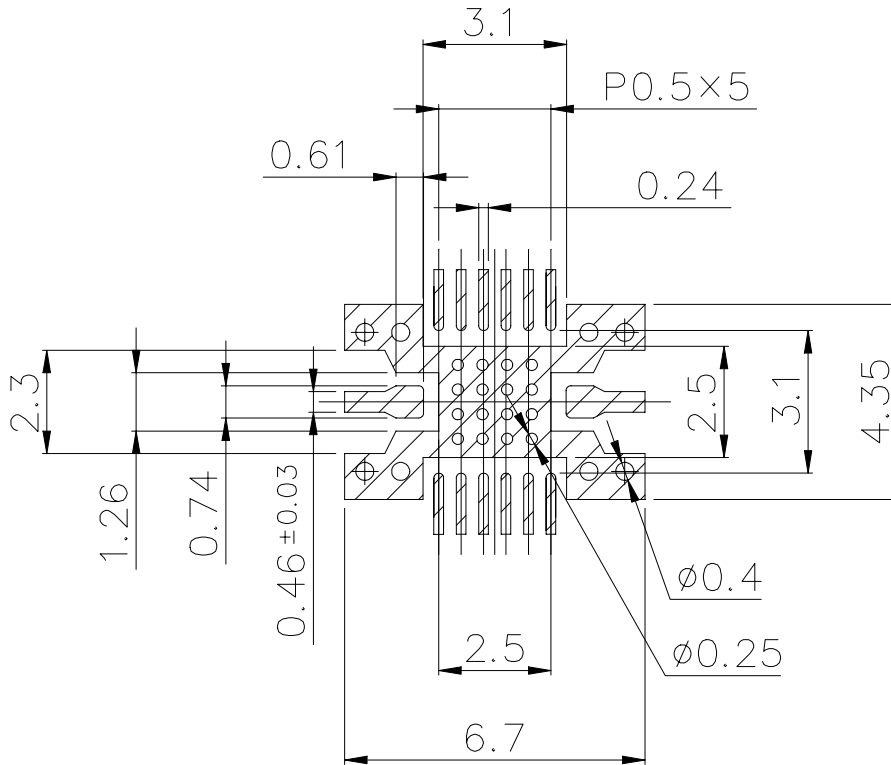

Unit : mm

Notes :

- LAMINATE : Rogers Corporation RO4003, Thickness $t=0.2\text{mm}$, Cu Foil $18\ \mu\text{m}$
Finish to copper foil ; Ni $0.1\ \mu\text{m}$ min./Au $0.1\pm 0.08\ \mu\text{m}$ (Both side)

Recommended Bias Network

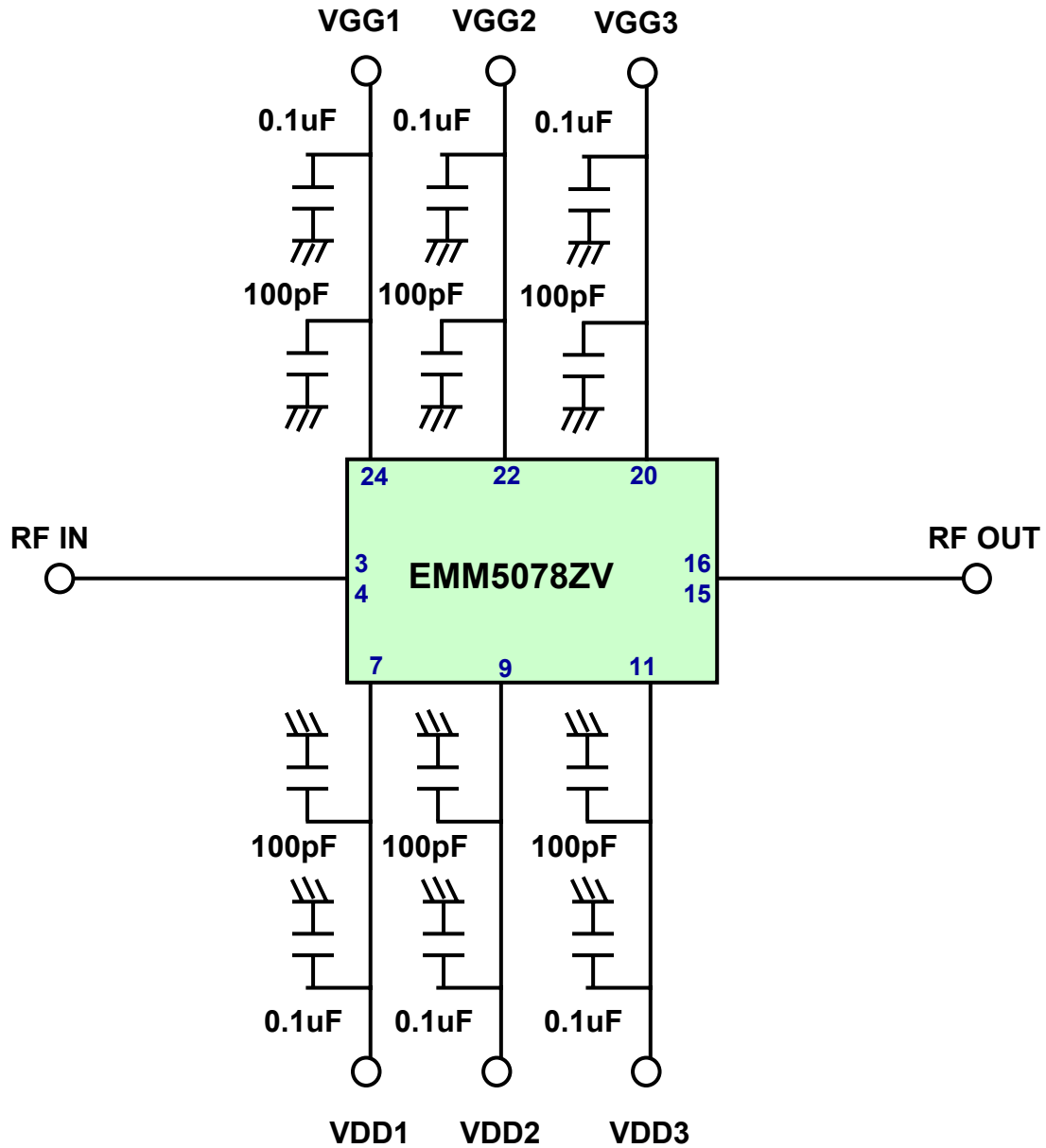

JDEC Tray Packing (Part No. : EMM5078ZV)

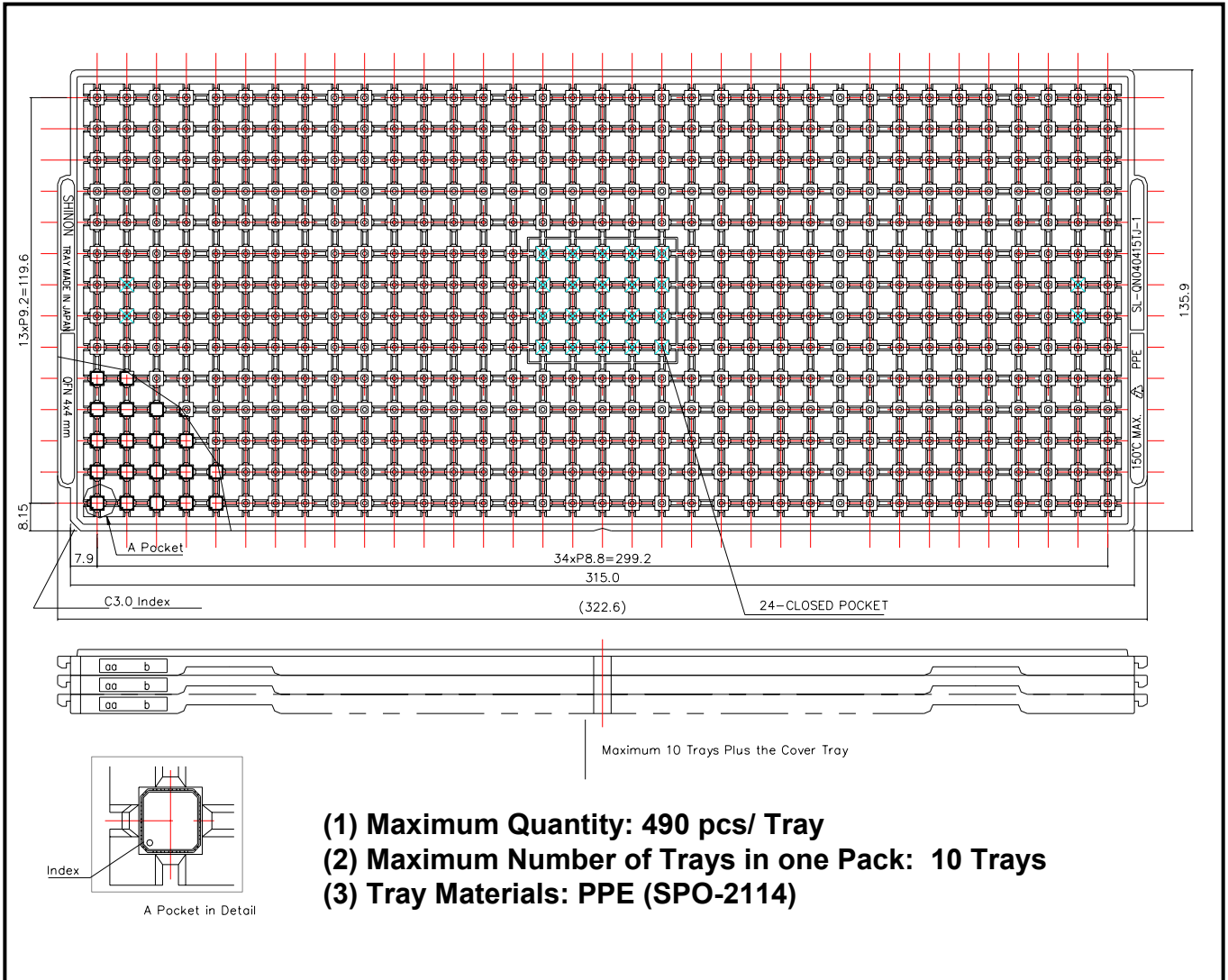

- (1) Maximum Quantity: 490 pcs/ Tray
- (2) Maximum Number of Trays in one Pack: 10 Trays
- (3) Tray Materials: PPE (SPO-2114)

■ Tape and Reel Packing (Part No. : EMM5078ZVT)

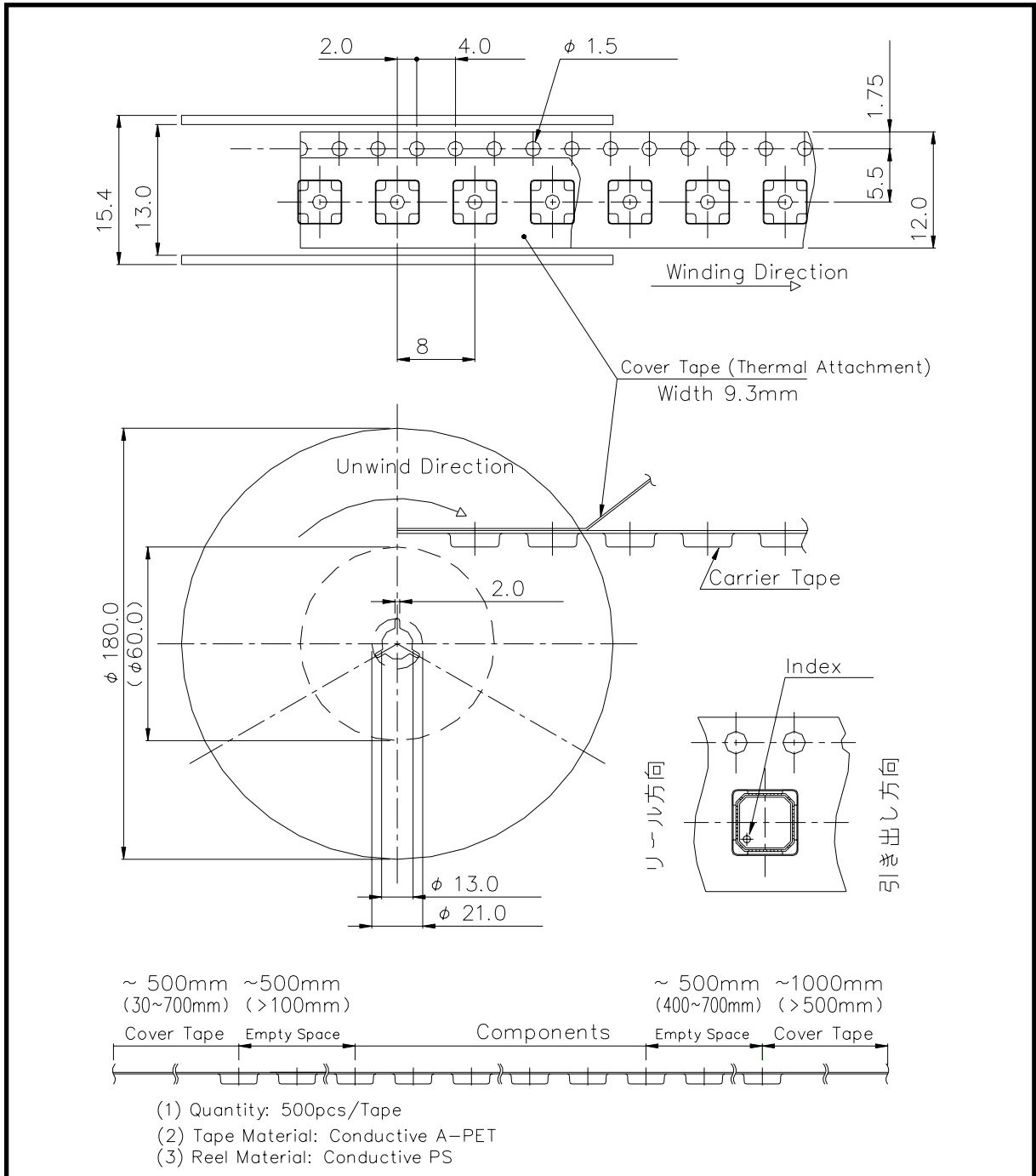

■ Mounting Method of SMD(Surface Mount Devices) for Lead-free solder

Mounting Condition

1. For soldering, Lead-free solder (Sn-3.0Ag-0.5Cu)*¹ or equivalent shall be used.
(*1: The figure displays with weight %. A predominantly tin-rich alloy with 3.0% silver and 0.5% copper.)
2. A rosin type flux with a chlorine content of 0.2% or less shall be used. The rosin flux with low halogen content is recommended.
3. When soldering, use one of the following time/ temperature methods for acceptable solder joints. Make sure the devices have been properly prepared with flux prior soldering.

* Reflow soldering method (Infrared reflow / Heat circulation reflow / Hot plate reflow):

Limit solder to 3 reflow cycles because resin is used in the modules manufacturing process. Excessive reflow cycles will effect the resin resulting in a potential failure or latent defect. The recommended reflow temperature profile is shown below. The temperature of the reflow profile must be measured at the device lead.

Reflow temperature profile and condition:

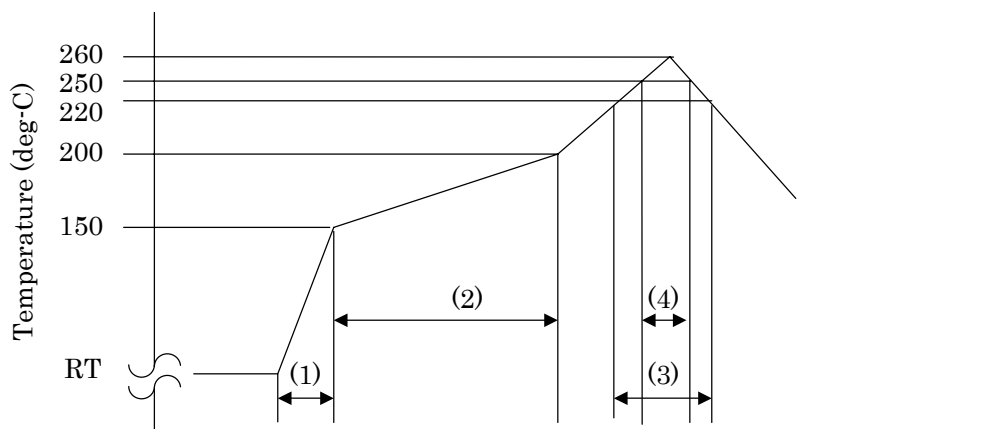

	Time
(1) Average Ramp-up Rate: 3 deg-C/seconds	
(2) Preheating: 150 - 200 deg-C,	60 - 180 seconds
(3) Main heating: 220 deg-C,	60 seconds max.
(4) Peak Temperature: 260 deg-C max., more than 250 deg-C,	10 seconds max.

* Measurement point: Device lead.

4. The above-recommended conditions were confirmed using the manufacture's equipment and materials. However, when soldering these products, the soldering condition should be verified by customer using their equipment and materials.



For further information please contact :

**Sumitomo Electric Device Innovations,
U.S.A., Inc.**

2355 Zanker Rd.
San Jose, CA 95131-1138, U.S.A.
TEL: +1 408 232-9500
FAX: +1 408 428-9111

Sumitomo Electric Europe Ltd.

220 Centennial Park,
Elestree WD6 3SL United Kingdom
TEL: +44 (0) 20 89538118
FAX: +44 (0) 20 89538228

Sumitomo Electric Europe Ltd. (Italy Branch)

Piazza Don E. Mapelli, 60-20099
Sesto San Giovanni, Milano- Italy
TEL: +39-02-496386-01
FAX: +39-02-496386-25

Sumitomo Electric Asia, Ltd.

Room 2624-2637, 26F
Sun Hung Kai Centre,
30 Harbour Road Wanchai,
Hong Kong
TEL: +852-2579-0080
FAX: +852-2576-6412

Sumitomo Electric Device Innovations, Inc.

1000 Kamisukiahara, showa-cho
Nakakomagun, Yamanashi
409-3883, Japan
(Kokubo Industrial Park)
TEL +81-55-275-4411
FAX +81-55-275-9461

Sumitomo Electric Industries, Ltd.

Head Office (Tokyo)
3-9-1, Shibaura, Minato-ku, Tokyo 108-8539,
Japan
TEL +81-3-6722-3287
FAX +81-3-6722-3284

CAUTION

Sumitomo Electric Device Innovations, Inc. products contain **gallium arsenide (GaAs)** which can be hazardous to the human body and the environment. For safety, observe the following procedures:

- Do not put these products into the mouth.
- Do not alter the form of this product into a gas, powder, or liquid through burning, crushing, or chemical processing as these by-products are dangerous to the human body if inhaled, ingested, or swallowed.
- Observe government laws and company regulations when discarding this product. This product must be discarded in accordance with methods specified by applicable hazardous waste procedures.

Sumitomo Electric Device Innovations, Inc. reserves the right to change products and specifications without notice. The information does not convey any license under rights of Sumitomo Electric Device Innovations, Inc. or others.

© 2010 Sumitomo Electric Device Innovations, Inc.



SUMITOMO ELECTRIC DEVICE INNOVATIONS