

Cree® PLCC4 1 in 1 SMD LED

CLM2B-REW&AEW

Data Sheet

SMD LEDs is packaged in the industry standard package. These LEDs have high reliability performance and are designed to work under a wide range of environmental conditions. This high reliability feature makes them ideally suited to be used under architectural lighting application conditions.

Its wide viewing angle makes these LEDs ideally suited for channel letter, or architectural lighting applications. The flat top emitting surface makes it easy for these LEDs to mate with light pipes.



FEATURES

- Size (mm): 3.2 x 2.7
- Color and Typical Dominant Wavelength (nm):
Red (624)
Amber (591)
- Luminous Intensity (mcd)
CLM2B-REW (2240-5600)
CLM2B-AEW (3550-9000)
- Viewing Angle: 60 degree
- Lead-Free
- RoHS Compliant

APPLICATIONS

- Light Strip
- Channel Letter
- Architectural Lighting



Absolute Maximum Ratings ($T_A = 25^\circ\text{C}$)

Items	Symbol	Absolute Maximum Rating	Unit
Forward Current	I_F	70	mA
Peak Forward Current ^{Note}	I_{FP}	200	mA
Reverse Voltage	V_R	5	V
Power Dissipation	P_D	210	mW
Operation Temperature	T_{opr}	-40 ~ +100	$^\circ\text{C}$
Storage Temperature	T_{stg}	-40 ~ +100	$^\circ\text{C}$
Junction Temperature	T_J	110	$^\circ\text{C}$
Junction/Ambient	R_{THJA}	300	$^\circ\text{C}/\text{W}$
Junction/Solder Point	R_{THJS}	150	$^\circ\text{C}/\text{W}$
Electrostatic Discharge Classification(MIL-STD-883E)	ESD	Class 2	

Note: Pulse width ≤ 10 msec, duty cycle $\leq 10\%$.

Typical Electrical & Optical Characteristics ($T_A = 25^\circ\text{C}$)

Characteristics	Color	Symbol	Condition	Unit	Minimum	Typical	Maximum
Forward Voltage	Red/Amber	V_F	$I_F = 50$ mA	V		2.5	3.0
Reverse Current	Red/Amber	I_R	$V_R = 5$ V	μA			10
Dominant Wavelength	Red	λ_D	$I_F = 50$ mA	nm	618	624	630
	Amber	λ_D	$I_F = 50$ mA	nm	584	591	599
Luminous Intensity	Red	I_v	$I_F = 50$ mA	mcd	2240	3700	
	Amber	I_v	$I_F = 50$ mA	mcd	3550	5000	
50% Power Angle	Red/Amber	$2\theta_{1/2}$	$I_F = 50$ mA	deg		60	



Intensity Bin Limit ($I_F = 50 \text{ mA}$)

Red

Bin Code	Min.(mcd)	Max.(mcd)
Xb	2240	2800
Ya	2800	3550
Yb	3550	4500
Z0	4500	5600

Amber

Bin Code	Min.(mcd)	Max.(mcd)
Yb	3550	4500
Z0	4500	5600
A0	5600	7100
B0	7100	9000

- Tolerance of measurement of luminous Intensity is $\pm 10\%$.

Color Bin Limit ($I_F = 50 \text{ mA}$)

Red

Bin Code	Min.(nm)	Max.(nm)
RA	618	630

Amber

Bin Code	Min.(nm)	Max.(nm)
A2	584	587
A3	587	590
A4	590	593
A5	593	596
A6	596	599

- Tolerance of measurement of dominant wavelength is $\pm 1 \text{ nm}$



Order Code Table*

Color	Kit Number	Viewing Angle	Luminous Intensity (mcd)		Dominant Wavelength			
			Min.	Max.	Color Bin	Min. (nm)	Color Bin	Max. (nm)
Red	CLM2B-REW-CXbZ0AA3	60	2240	5600	RA	618	RA	630
Red	CLM2B-REW-CYaZ0AA3	60	2800	5600	RA	618	RA	630
Red	CLM2B-REW-CYbZ0AA3	60	3550	5600	RA	618	RA	630

Color	Kit Number	Viewing Angle	Luminous Intensity (mcd)		Dominant Wavelength			
			Min.	Max.	Color Bin	Min. (nm)	Color Bin	Max. (nm)
Amber	CLM2B-AEW-CYbB0263	60	3550	9000	A2	584	A6	599
Amber	CLM2B-AEW-CZ0B0353	60	4500	9000	A3	587	A5	596

Notes:

1. The above Kit Numbers represent order codes which include multiple intensity bin and color bin codes. Only one intensity bin code and one color bin code will be shipped on each reel. Single intensity bin code and single color bin codes will not be orderable.
2. Please refer to the "Cree LED Lamp Reliability Test Standards" document for reliability test conditions.
3. Please refer to the "Cree LED Lamp Soldering & Handling" document for information about how to use this LED product safely.

Important Bins Notes:

- Packaging methods are available for selection; please refer to the "Cree LED Lamp Packaging Standard" document.
- Please refer to the "Cree LED Lamp Reliability Test Standards" document for reliability test conditions.
- Please refer to the "Cree LED Lamp Soldering & Handling" document for information about how to use this LED product safely.

Graphs

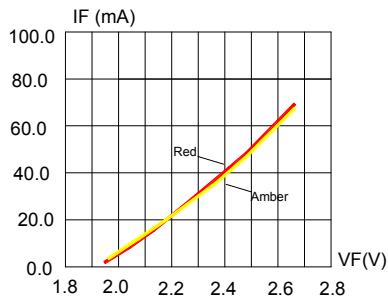

FIG.1 FORWARD CURRENT VS. FORWARD VOLTAGE.

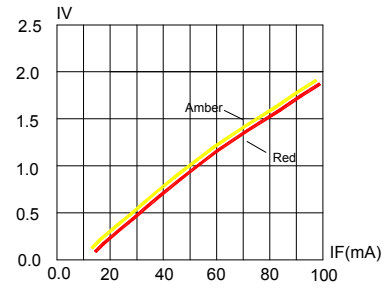

FIG.2 RELATIVE LUMINOUS INTENSITY VS. FORWARD CURRENT

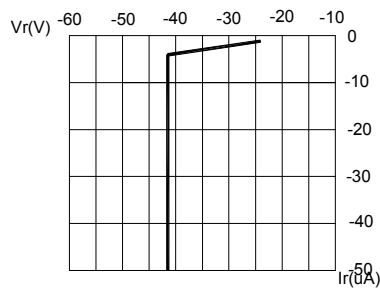

FIG.3 RED&AMBER REVERSE CURRENT VS. REVERSE VOLTAGE.

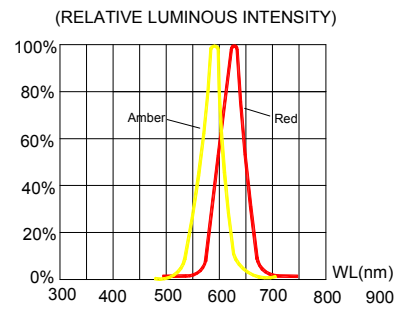

FIG.4 RELATIVE LUMINOUS INTENSITY VS. WAVELENGTH.

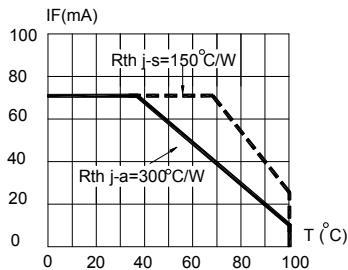

FIG.5 RED&AMBER MAXIMUM FORWARD DCCURRENT VS AMBIENT TEMPERATURE ($T_{jmax}=110^{\circ}C$)

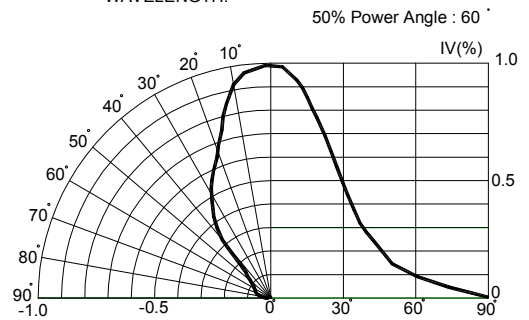
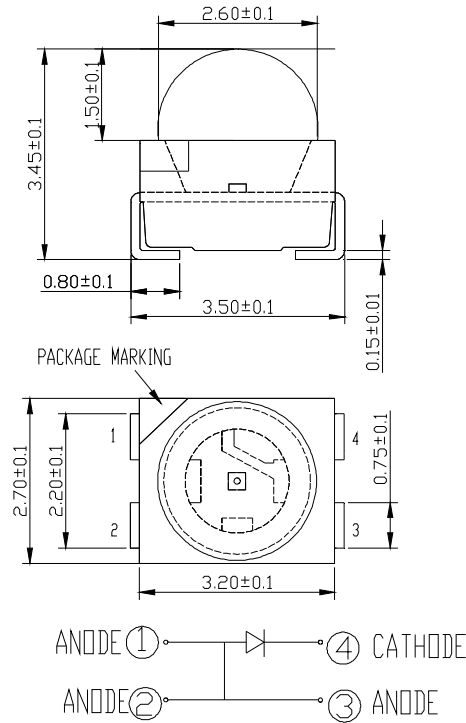

FIG.6 RED&AMBER FAR FIELD PATTERN

Mechanical Dimensions

All dimensions are in mm.



Notes

RoHS Compliance

The levels of environmentally sensitive, persistent biologically toxic (PBT), persistent organic pollutants (POP), or otherwise restricted materials in this product are below the maximum concentration values (also referred to as the threshold limits) permitted for such substances, or are used in an exempted application, in accordance with EU Directive 2002/95/EC on the restriction of the use of certain hazardous substances in electrical and electronic equipment (RoHS), as amended through April 21, 2006.

Vision Advisory Claim

Users should be cautioned not to stare at the light of this LED product. The bright light can damage the eye.



Kit Number System

Cree LED lamps are tested and sorted into performance bins. A bin is specified by ranges of color, forward voltage, and brightness. Sorted LEDs are packaged for shipping in various convenient options. Please refer to the "Cree LED Lamp Packaging Standard" document for more information about shipping and packaging options.

Cree LEDs are sold by order codes in combinations of bins called kits. Order codes are configured in the following manner:

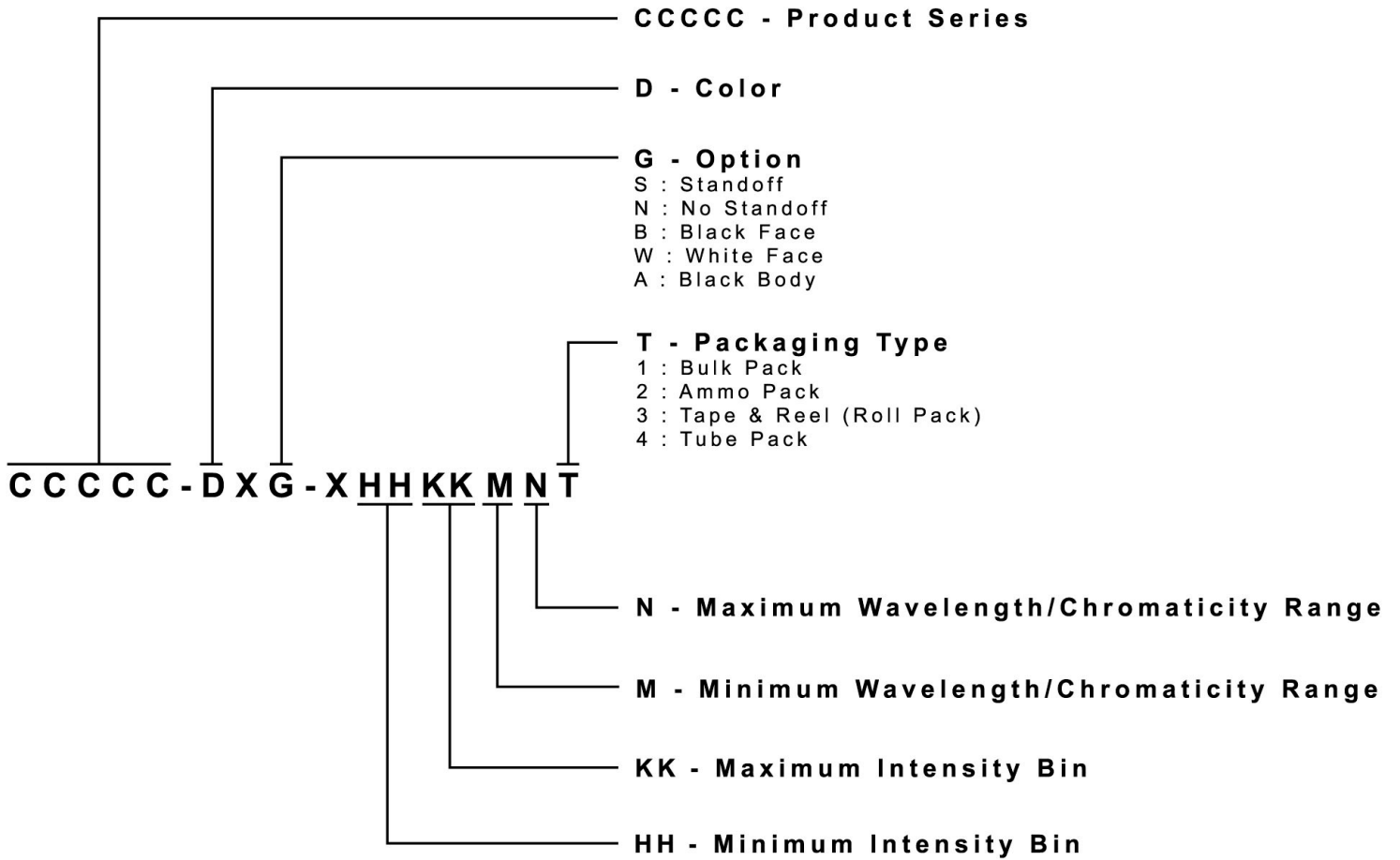

Packaging

- The boxes are not water resistant and they must be kept away from water and moisture.
- The LEDs are packed in cardboard boxes after packaging in normal or anti-electrostatic bags.
- Cardboard boxes will be used to protect the LEDs from mechanical shocks during transportation.
- The reel pack is applied in SMD LED.
- Max 2000 pcs per reel.

