

OVERVIEW

The CF5074B is VCXO module IC with built-in varicap diodes. The integrated varicap diode BiCMOS process allows the device to be fabricated on a single chip. A newly developed oscillator circuit features reduced drive level of crystal and wide pullrange. A VCXO module can be constructed with just the connection of a crystal unit, making the devices ideal as surface-mounted, compact VCXO modules.

FEATURES

- 2.25 to 3.6V operating supply voltage range
- 50MHz to 80MHz operating frequency range
- Varicap diode built-in
- Oscillation start-up detector function
- CMOS output duty level
- 4mA (min) output drive capability
- 15pF output load
- Standby function
 - High impedance in standby mode
- BiCMOS process
- Chip form (CF5074B)

APPLICATIONS

- VCXO modules

ORDERING INFORMATION

Device	Package
CF5074B-1	Chip form
CF5074B-3	

PAD LAYOUT

(Unit: μm)

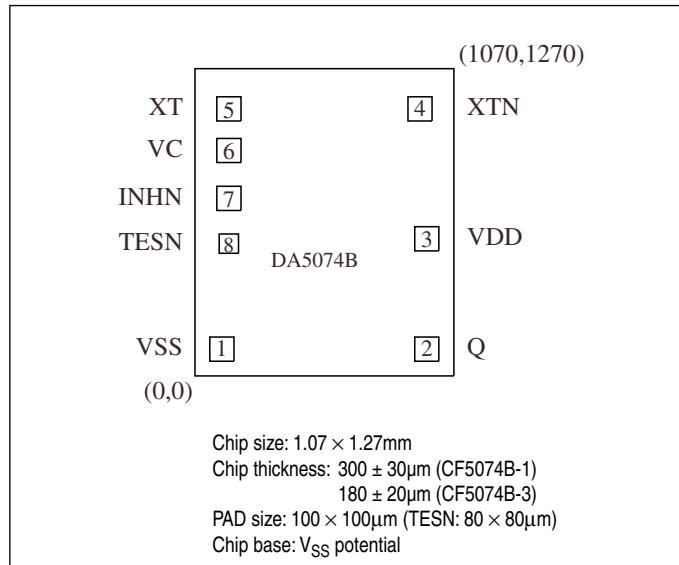

PAD DESCRIPTION AND DIMENSIONS

Pad No.	Name	I/O	Description	Pad dimensions [μm]	
				X	Y
1	VSS	-	(-) supply pin	111	111
2	Q	O	Output pin. High-impedance in standby mode	958	111
3	VDD	-	(+) supply pin	958	567
4	XTN	O	Oscillator output. Crystal connection pin	930	1104
5	XT	I	Oscillator input. Crystal connection pin	140	1104
6	VC	I	Oscillation frequency control voltage input pin. Positive polarity (frequency increases with increasing voltage)	140	932
7	INH	I	Output state control voltage input pin. Standby mode when LOW. Power-saving pull-up resistor built-in	140	734
8	TESN	I	Test pin (leave open)	140	547

BLOCK DIAGRAM

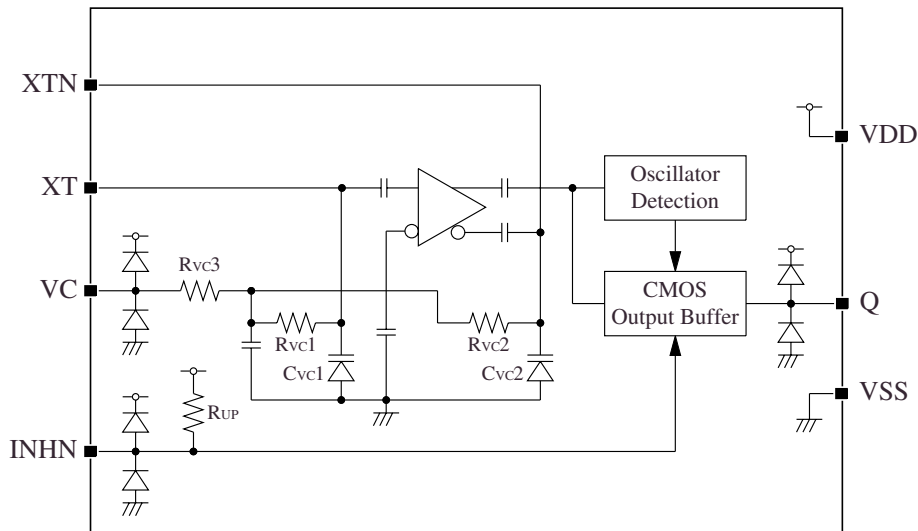

ABSOLUTE MAXIMUM RATINGS

$V_{SS} = 0V$ unless otherwise noted.

Parameter	Symbol	Rating	Unit
Supply voltage range	V_{DD}	-0.5 to 7.0	V
Input voltage range	V_{IN}	-0.5 to $V_{DD} + 0.5$	V
Output voltage range	V_{OUT}	-0.5 to $V_{DD} + 0.5$	V
Storage temperature range	T_{STG}	-65 to +150	°C
Output current	I_{OUT}	20	mA

RECOMMENDED OPERATING CONDITIONS

$V_{SS} = 0V$ unless otherwise noted.

Parameter	Symbol	Rating			Unit
		Min	Typ	Max	
Operating supply voltage	V_{DD}	2.25	-	3.6	V
Output frequency	f_{OUT}	50	-	80	MHz
Output load capacitance	C_L	-	-	15	pF
Input voltage	V_{IN}	V_{SS}	-	V_{DD}	V
Operating temperature	T_{OPR}	-40	+25	+85	°C

ELECTRICAL CHARACTERISTICS

$V_{DD} = 2.25$ to $3.6V$, $V_C = 0.5V_{DD}$, $V_{SS} = 0V$, $T_a = -40$ to $+85^\circ C$ unless otherwise noted.

Parameter	Symbol	Conditions	Rating			Unit	
			Min	Typ	Max		
Current consumption	I_{DD}	Measurement circuit 2, load circuit 1, INHN = open, $C_L = 15pF$, $f = 80MHz$	$V_{DD} = 2.25$ to $2.75V$	–	20	30	mA
			$V_{DD} = 3.0$ to $3.6V$	–	26	36	mA
HIGH-level output voltage	V_{OH}	Q: Measurement circuit 1, $I_{OH} = -4mA$	$V_{DD} - 0.4$	$V_{DD} - 0.2$	–	V	
LOW-level output voltage	V_{OL}	Q: Measurement circuit 1, $I_{OL} = 4mA$	–	0.2	0.4	V	
Output leakage current	I_Z	Q: Measurement circuit 6, INHN = LOW	$V_{OH} = V_{DD}$	–	–	10	μA
			$V_{OL} = V_{SS}$	–	–	10	μA
HIGH-level input voltage	V_{IH}	INHN	$0.7V_{DD}$	–	–	V	
LOW-level input voltage	V_{IL}	INHN	–	–	$0.3V_{DD}$	V	
INHN pull-up resistance	R_{UP1}	Measurement circuit 3	INHN = V_{SS}	0.4	0.8	1.2	$M\Omega$
	R_{UP2}		INHN = $0.7V_{DD}$	15	–	150	$k\Omega$
Oscillator block built-in resistance	R_{VC1}	Measurement circuit 4		75	150	225	$k\Omega$
	R_{VC2}			75	150	225	$k\Omega$
	R_{VC3}			10	30	90	$k\Omega$
Oscillator block built-in capacitance	C_{VC}	Capacitance of C_{VC1} and C_{VC2}	$V_C = 0.3V$	13	16.3	19.6	pF
			$V_C = 1.65V$	6.7	8.9	10.9	pF
			$V_C = 3.0V$	3.3	4.7	6.1	pF
VC input resistance	R_{VIN}	Measurement circuit 7, $T_a = 25^\circ C$	10	–	–	$M\Omega$	
VC input impedance	Z_{VIN}	Measurement circuit 8, $V_C = 0V$, $f = 10kHz$, $T_a = 25^\circ C$	–	250	–	$k\Omega$	
VC input capacitance	C_{VIN}	Measurement circuit 8, $V_C = 0V$, $f = 10kHz$, $T_a = 25^\circ C$	–	60	–	pF	
Modulation bandwidth	fm	Measurement circuit 9, $-3dB$ frequency, $V_{DD} = 3.3V$, $V_C = 3.3V_{p-p}$, $T_a = 25^\circ C$, crystal: $f = 80MHz$, $C0 = 4.8pF$, $\gamma \leq 440$	–	30	–	kHz	

SWITCHING CHARACTERISTICS

$V_{DD} = 2.25$ to $3.6V$, $V_C = 0.5V_{DD}$, $V_{SS} = 0V$, $T_a = -40$ to $+85^\circ C$ unless otherwise noted.

Parameter	Symbol	Conditions	Rating			Unit	
			Min	Typ	Max		
Output rise time	t_{r1}	Measurement circuit 2, load circuit 1, $0.2V_{DD} \rightarrow 0.8V_{DD}$, $T_a = 25^\circ C$, $C_L = 15pF$	–	2.5	4	ns	
Output fall time	t_{f1}	Measurement circuit 2, load circuit 1, $0.8V_{DD} \rightarrow 0.2V_{DD}$, $T_a = 25^\circ C$, $C_L = 15pF$	–	2.5	4	ns	
Output duty cycle	Duty	Measurement circuit 2, load circuit 1, $T_a = 25^\circ C$, $C_L = 15pF$	$V_{DD} = 2.5V$	40	50	60	%
			$V_{DD} = 3.3V$	45	50	55	%
Output disable delay time	t_{PLZ}	Measurement circuit 5, load circuit 1, $T_a = 25^\circ C$, $C_L \leq 15pF$	–	–	100	ns	
Output enable delay time	t_{PZL}		–	–	100	ns	

MEASUREMENT CIRCUITS

Measurement Circuit 1

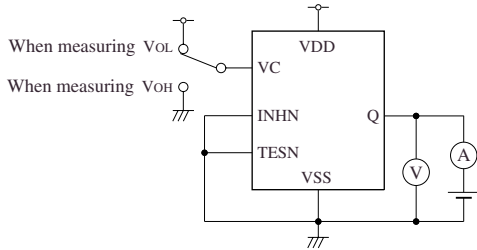

Measurement Circuit 2

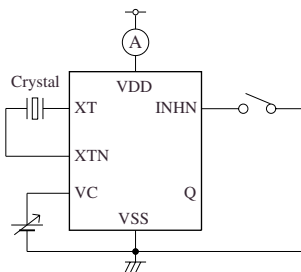

$V_C = 0.5V_{DD}$, INHN = open, crystal oscillation

Measurement Circuit 3

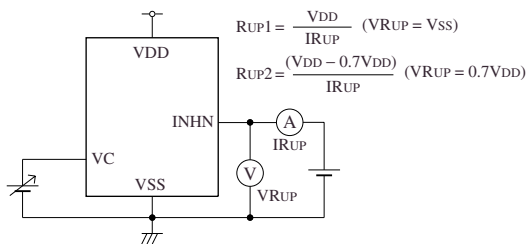

$V_C = 0.5V_{DD}$

$$R_{UP1} = \frac{V_{DD}}{I_{RUP}} \quad (V_{RUP} = V_{SS})$$

$$R_{UP2} = \frac{(V_{DD} - 0.7V_{DD})}{I_{RUP}} \quad (V_{RUP} = 0.7V_{DD})$$

Measurement Circuit 4

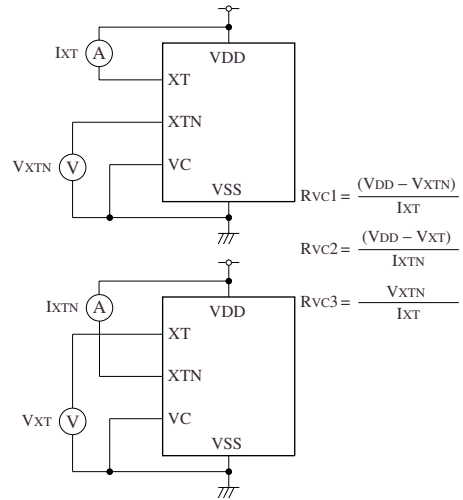

$$R_{VC1} = \frac{(V_{DD} - V_{XTN})}{I_{XT}}$$

$$R_{VC2} = \frac{(V_{DD} - V_{XT})}{I_{XTN}}$$

$$R_{VC3} = \frac{V_{XTN}}{I_{XT}}$$

Measurement Circuit 5

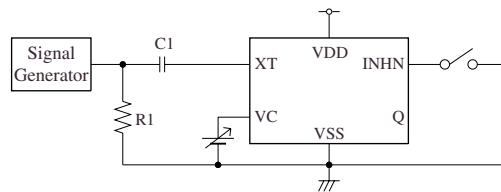

XT input signal: 10MHz, 1.0Vp-p
 $C1 = 0.001\mu F$, $R1 = 50\Omega$, $V_C = 0.5V_{DD}$

Measurement Circuit 6

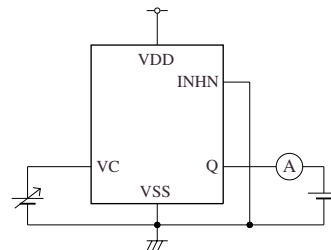

$V_C = 1/2V_{DD}$

Measurement Circuit 7

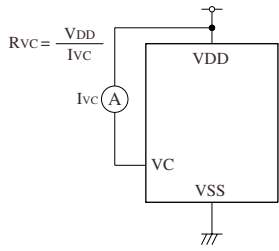

Measurement Circuit 8

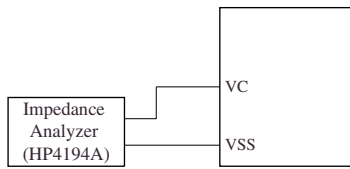

VC input signal: 100Hz to 10kHz, 0.1Vp-p, $V_C = 0V$

Measurement Circuit 9

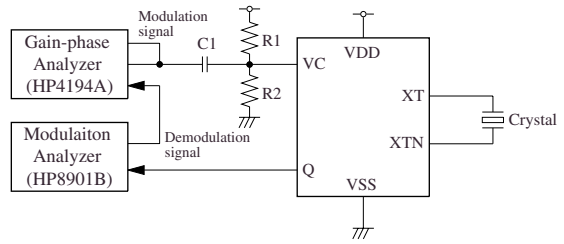

$C1 = 20\mu F$, $R1 = R2 = 100M\Omega$, $V_{DD} = 3.3V$
 VC modulation signal: 100Hz to 100kHz, 3.3Vp-p

Load Circuit 1

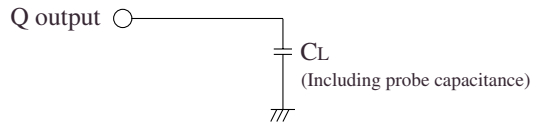

Switching Time Measurement Waveform

Output duty level, t_r , t_f

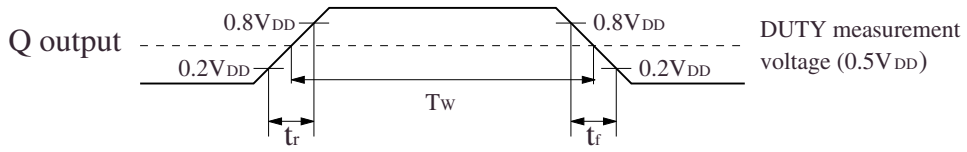

Output duty cycle

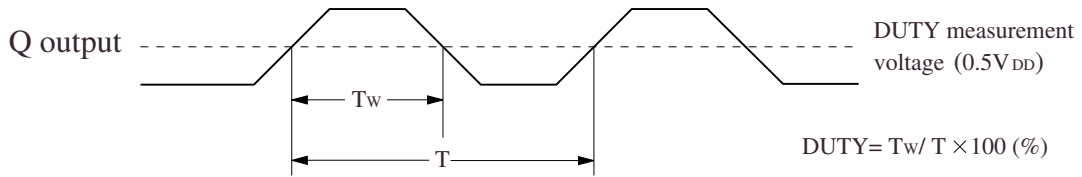

Output Enable/Disable Delay Times

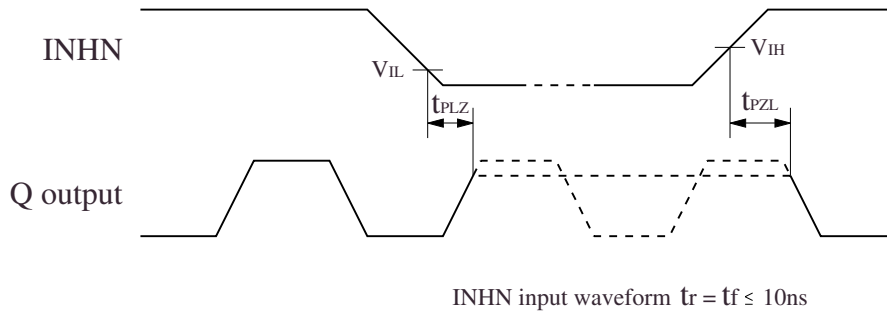

FUNCTIONAL DESCRIPTION

Standby Function

When INHN goes LOW, the device is in standby mode. The Q output becomes high impedance and the oscillator circuit continues running.

INHN	Q	Oscillator
HIGH (or open)	f_0	Operating
LOW	High impedance	Operating

Power-saving Pull-up Resistor

The INHN pin pull-up resistance changes in response to the input level (HIGH or LOW). When INHN is tied LOW, the pull-up resistance becomes large, reducing the current consumed by the resistance. When INHN is left open, the pull-up resistance becomes small, such that even if the input is affected by external noise the outputs are stable due to INHN being tied HIGH by the pull-up resistor.

Oscillation Start-up Detector Function

The devices also feature an oscillation start-up detector circuit. This circuit functions to disable the outputs until the oscillation starts. This prevents unstable oscillator output at oscillator start-up when power is applied.

TYPICAL CHARACTERISTICS

The following characteristics measured using the crystal for NPC characteristics authentication. Note that the characteristics will vary with the crystal used.

Frequency Pullrange, Oscillator Equivalent Capacitance (C_L) Characteristics

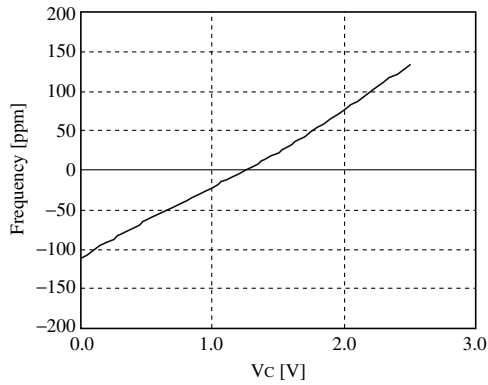

$V_{DD} = 2.5V$ ($V_C = 1.25V$ reference)

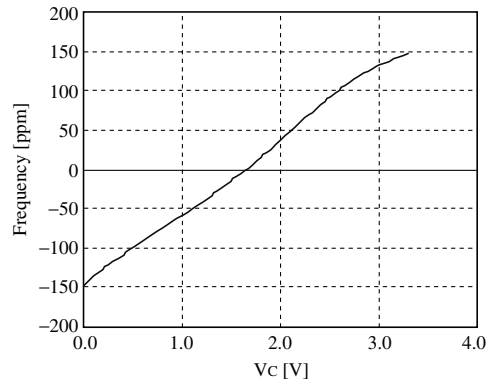

$V_{DD} = 3.3V$ ($V_C = 1.65V$ reference)

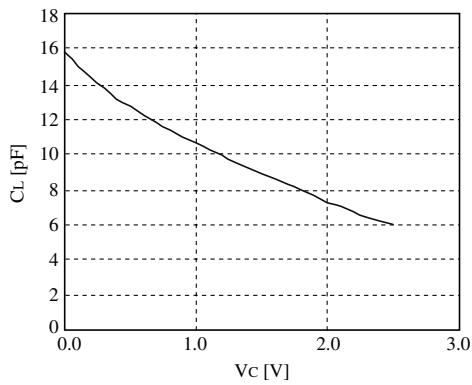

$V_{DD} = 2.5V$

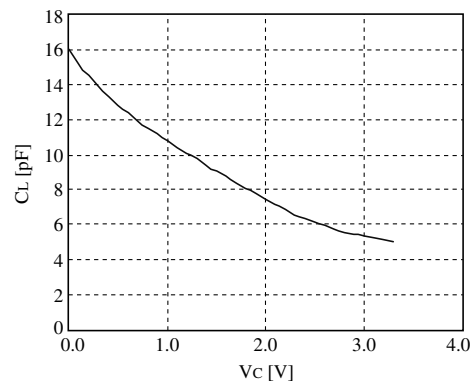

$V_{DD} = 3.3V$

Measurement circuit

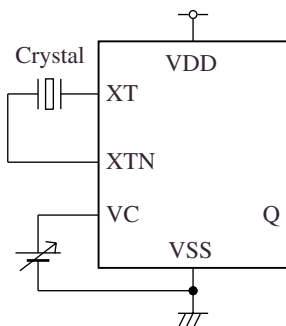

Crystal: $f = 80\text{MHz}$, $C_0 = 4.8\text{pF}$, $\gamma = 440$

C_L : Oscillator equivalent capacitance is determined by the oscillator frequency.

Negative Resistance Characteristics

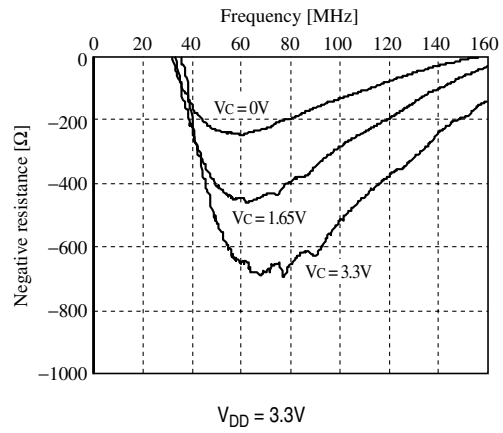
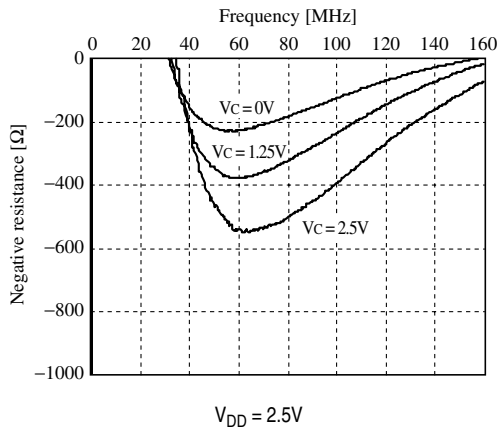

Measurement circuit

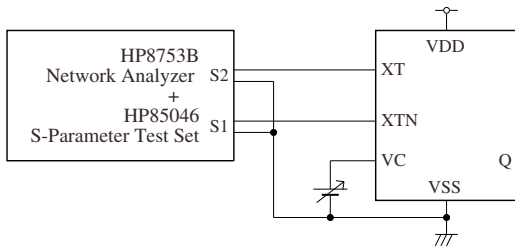

Modulation Characteristics

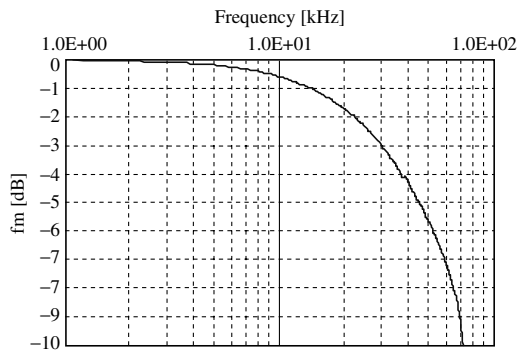

Measurement circuit

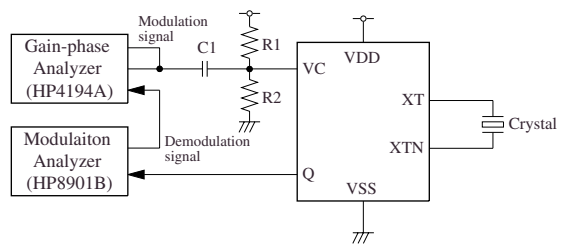

$C1 = 20\mu F$, $R1 = R2 = 100M\Omega$, $V_{DD} = 3.3V$
 VC modulation signal: 100Hz to 100kHz, 3.3Vp-p

Output Waveform

Measurement equipment

- Oscilloscope: 54855A (Agilent)

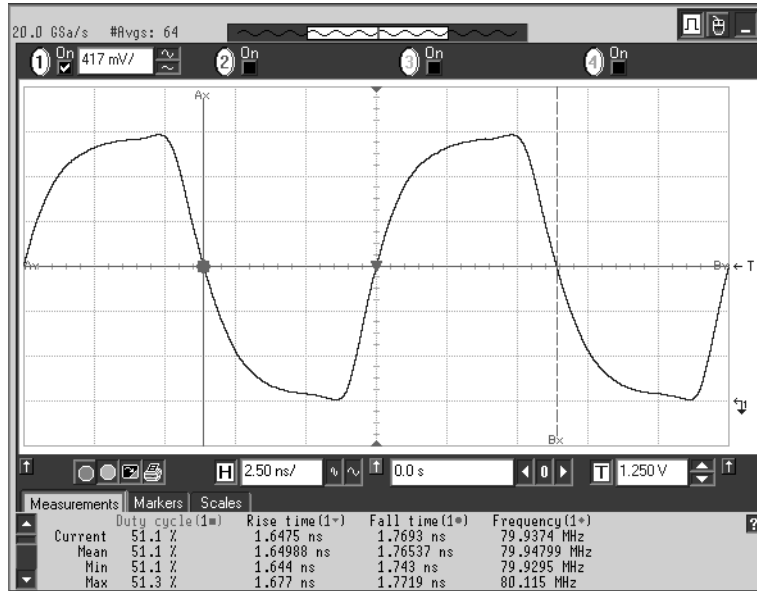

$V_{DD} = 2.5V$, 15pF load, $V_C = 1.25V$

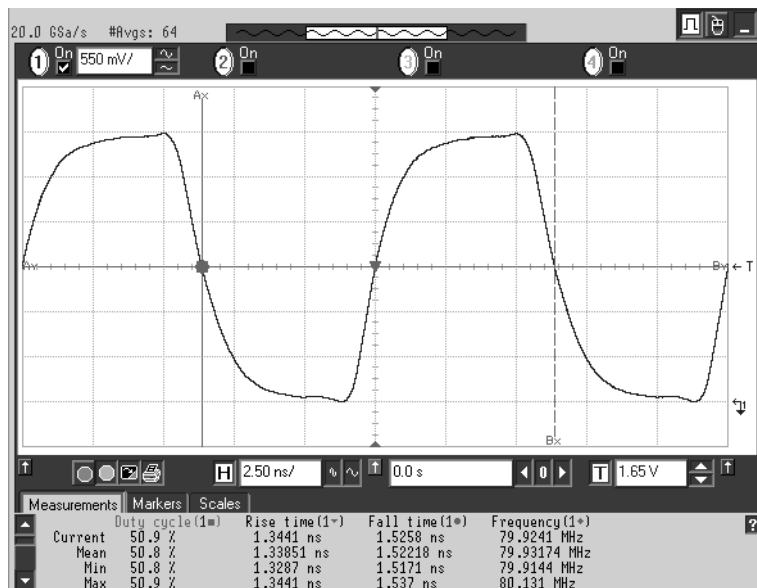

$V_{DD} = 3.3V$, 15pF load, $V_C = 1.65V$

Relation Between Pulling Range and Constants for Crystal Units

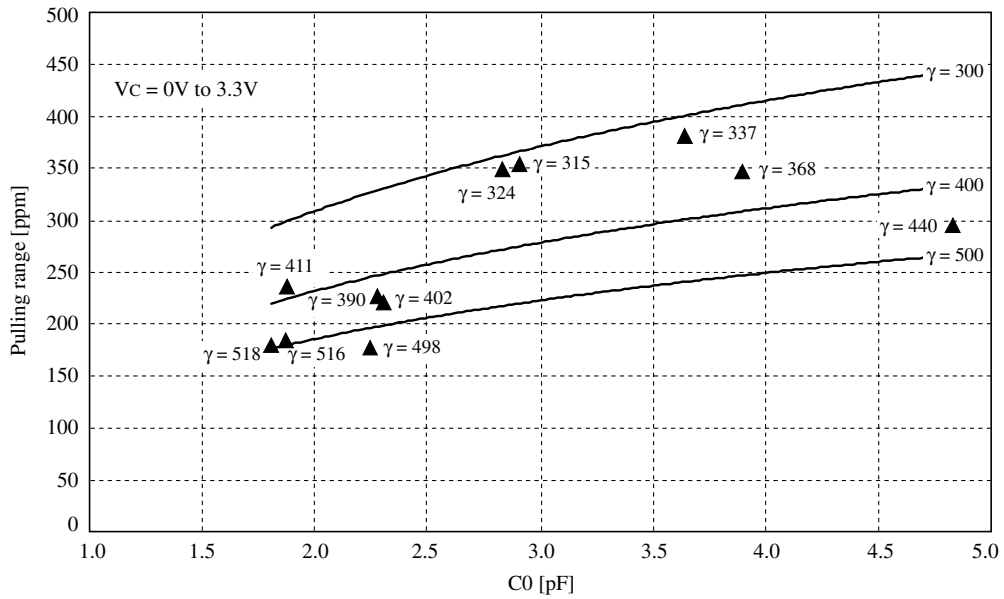

Measurement data when crystal is changed.

	A	B	C	D	E	F	G	H	I	J	L
C_0 [pF]	4.8	3.6	1.8	1.9	2.2	1.9	2.3	3.9	2.9	2.8	2.3
γ	440	337	518	411	498	516	402	368	315	324	390
Pulling range ¹ [ppm]	295	381	179	235	177	184	220	346	354	349	227

1. Pulling range: Value of changes in VC voltage from 0V to 3.3V.

Measurement circuit

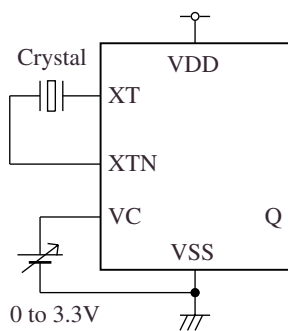

Please pay your attention to the following points at time of using the products shown in this document.

The products shown in this document (hereinafter "Products") are not intended to be used for the apparatus that exerts harmful influence on human lives due to the defects, failure or malfunction of the Products. Customers are requested to obtain prior written agreement for such use from SEIKO NPC CORPORATION (hereinafter "NPC"). Customers shall be solely responsible for, and indemnify and hold NPC free and harmless from, any and all claims, damages, losses, expenses or lawsuits, due to such use without such agreement. NPC reserves the right to change the specifications of the Products in order to improve the characteristic or reliability thereof. NPC makes no claim or warranty that the contents described in this document do not infringe any intellectual property right or other similar right owned by third parties. Therefore, NPC shall not be responsible for such problems, even if the use is in accordance with the descriptions provided in this document. Any descriptions including applications, circuits, and the parameters of the Products in this document are for reference to use the Products, and shall not be guaranteed free from defect, inapplicability to the design for the mass-production products without further testing or modification. Customers are requested not to export or re-export, directly or indirectly, the Products to any country or any entity not in compliance with or in violation of the national export administration laws, treaties, orders and regulations. Customers are requested appropriately take steps to obtain required permissions or approvals from appropriate government agencies.

The logo for SEIKO NPC CORPORATION, consisting of the letters 'NPC' in a bold, black, sans-serif font.**SEIKO NPC CORPORATION**

1-9-9, Hatchobori, Chuo-ku,
Tokyo 104-0032, Japan
Telephone: +81-3-5541-6501
Facsimile: +81-3-5541-6510
<http://www.npc.co.jp/>
Email: sales@npc.co.jp

NC0716AE 2007.12