

FRD

30A Avg 600 Volts

P2H30F6

■回路図 CIRCUIT

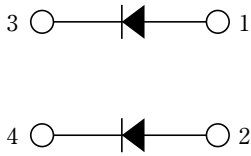

■外形寸法図 OUTLINE DRAWING (単位 Dimension : mm)

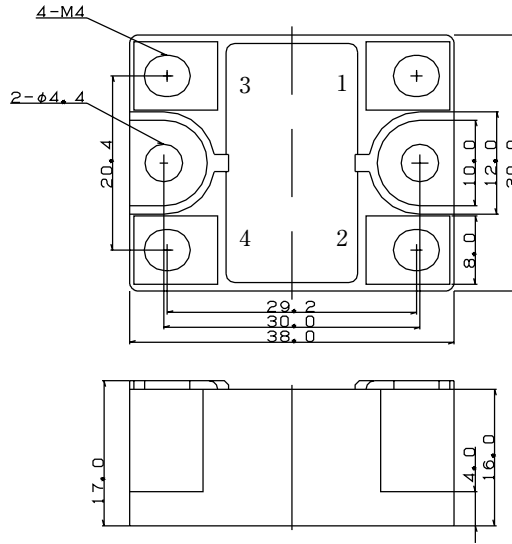

■最大定格 Maximum Ratings

項目 Parameter	記号 Symbol	耐圧クラス Grade		単位 Unit
		P2H30F6		
くり返しピーク逆電圧 Repetitive Peak Reverse Voltage	*1 V _{RRM}	600		V
非くり返しピーク逆電圧 Non Repetitive Peak Reverse Voltage	*1 V _{RSM}	—		V

項目 Parameter	記号 Symbol	条件 Conditions	定格値 Max. Rated Value	単位 Unit		
平均整流電流 Average Rectified Output Current	*1 I _o (AV)	商用周波数 180° 通電 Half Sine Wave T _c = 64°C	30	A		
実効順電流 RMS Forward Current	*1 I _{F(RMS)}		47	A		
サージ順電流 Surge Forward Current	*1 I _{FSM}	50Hz正弦半波, 1 サイクル, 非くり返し Half Sine Wave, 1 Pulse, Non-Repetitive	400	A		
電流二乗時間積 I Squared t	*1 I ² t	2 ~ 10ms	800	A ² s		
動作接合温度範囲 Operating Junction Temperature Range	T _{jw}		-40 ~ +150	°C		
保存温度範囲 Storage Temperature Range	T _{stg}		-40 ~ +125	°C		
絶縁耐圧 Isolation Voltage	V _{iso}	端子-ベース間, AC 1 分間 Terminal to Base, AC 1 min.	2500	V		
締付トルク Mounting Torque	ベース部 Mounting	F	サーマルコンパウンド塗布 Greased	M4	1.5 (1.4)	N·m
	主端子部 Terminal			M4	1.5 (1.4)	N·m

■電気的特性 Electrical Characteristics

項目 Parameter	記号 Symbol	条件 Conditions	特性値 (最大) Maximum Value	単位 Unit
ピーク逆電流 Peak Reverse Current	*1 I _{RM}	T _j = 25°C, V _{RM} = V _{RRM}	50	μA
ピーク順電圧 Peak Forward Voltage	*1 V _{FM}	T _j = 25°C, I _{FM} = 30A	1.70	V
逆回復時間 Reverse Recovery Time	*1 t _{rr}	T _j = 25°C, I _{FM} = 10A, -di/dt = 50A/μs	60	ns
熱抵抗 Thermal Resistance	*1 R _{th(j-c)}	接合部-ケース間 Junction to Case	1.30	°C/W
接触熱抵抗 Thermal Resistance	R _{th(c-f)}	ケース-フィン間(トータル), サーマルコンパウンド塗布 Case to Fin, Total, Greased	0.3	°C/W

質量…約35g
Approximate Weight

*1: 1 アーム当りの値 Value Per 1 Arm.

■ 定格・特性曲線

順電圧特性
FORWARD CURRENT VS. VOLTAGE

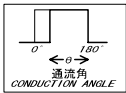
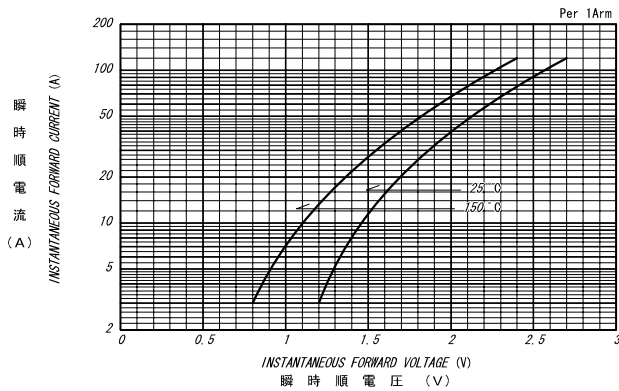

平均順電力損失特性
AVERAGE FORWARD POWER DISSIPATION

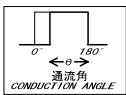
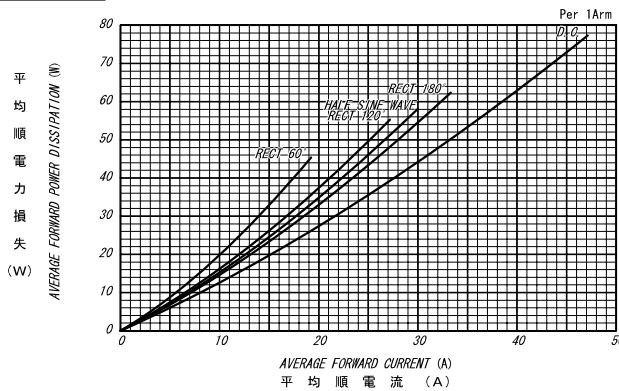

平均順電流 - ケース温度定格
AVERAGE FORWARD CURRENT VS. CASE TEMPERATURE

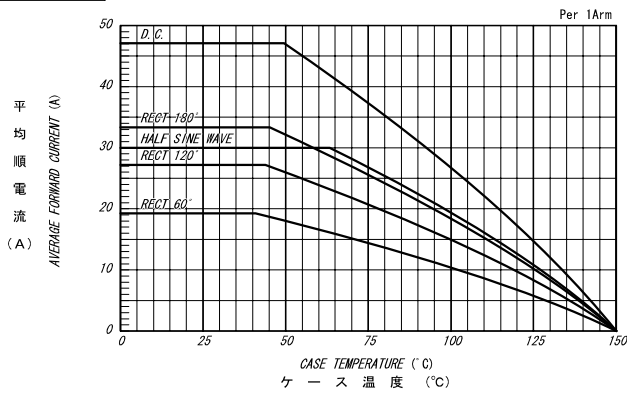

サージ順電流定格
SURGE CURRENT RATINGS

f=50Hz, Half Sine Wave, Non-Repetitive, No Load

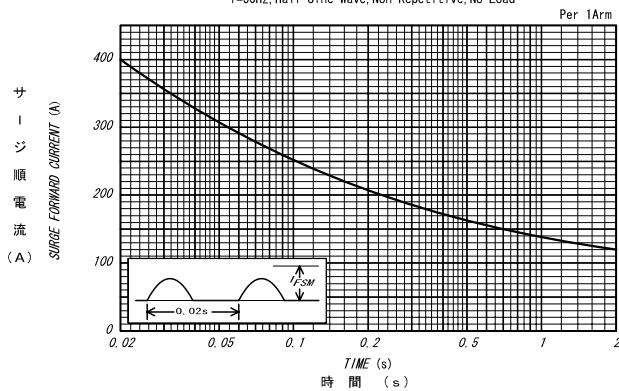

過渡熱抵抗特性
MAXIMUM TRANSIENT THERMAL IMPEDANCE

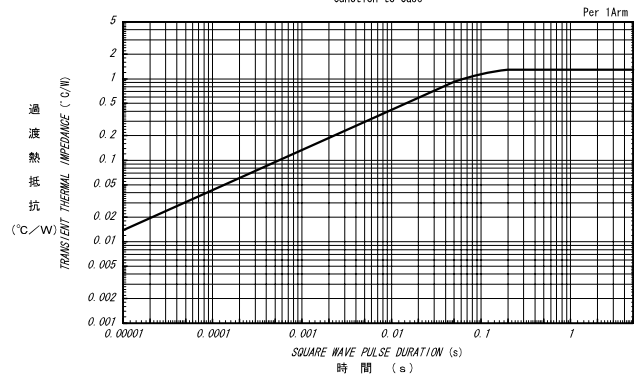

FR-05B05Hシールド