

Thyristor – Diode Module

Features

- Improved glass passivation for high reliability
- Exceptional stability at high temperatures
- High di/dt and dv/dt capabilities
- Low thermal resistance

Maximum Ratings ($T_A = 25^\circ\text{C}$ unless otherwise noted)

Parameter	Symbol	Values	Units
Maximum average forward current @ $T_J = 85^\circ\text{C}$	$I_{F(AV)}$	56	A
Maximum average RMS forward current	$I_{F(RMS)}$	130	A
Maximum non-repetitive surge current @ $t = 10\text{ms}$	I_{FSM}	1300	A
Maximum I^2t for fusing @ $t = 10\text{ms}$	I^2t	8000	A^2s



M1 PACKAGE

Thermal & Mechanical Specifications ($T_A = 25^\circ\text{C}$ unless otherwise noted)

Parameter	Symbol	Values	Units
Operating junction temperature range	T_J	-65 to +125	$^\circ\text{C}$
Thermal resistance, junction to case	$R_{th(JC)}$	0.55	$^\circ\text{C}/\text{W}$

Electrical Characteristics ($T_A = 25^\circ\text{C}$ unless otherwise noted)

Parameter	Symbol	Values	Units
Maximum average on-state current	$I_{T(max)}$	56	A
Maximum repetitive peak reverse voltage range	V_{RRM}	200 to 1600	V
Forward voltage drop	V_{FM}	1.2	V
Gate current required to trigger	I_{GT}	100	A
Gate voltage required to trigger	V_{GT}	2	V
Holding current range	I_H	5 to 100	mA
Maximum latching current	I_L	400	mA
Critical rate of rise of off-state voltage	dv/dt	300	$\text{V}/\mu\text{s}$
RMS isolated voltage	V_{ISO}	2500	V

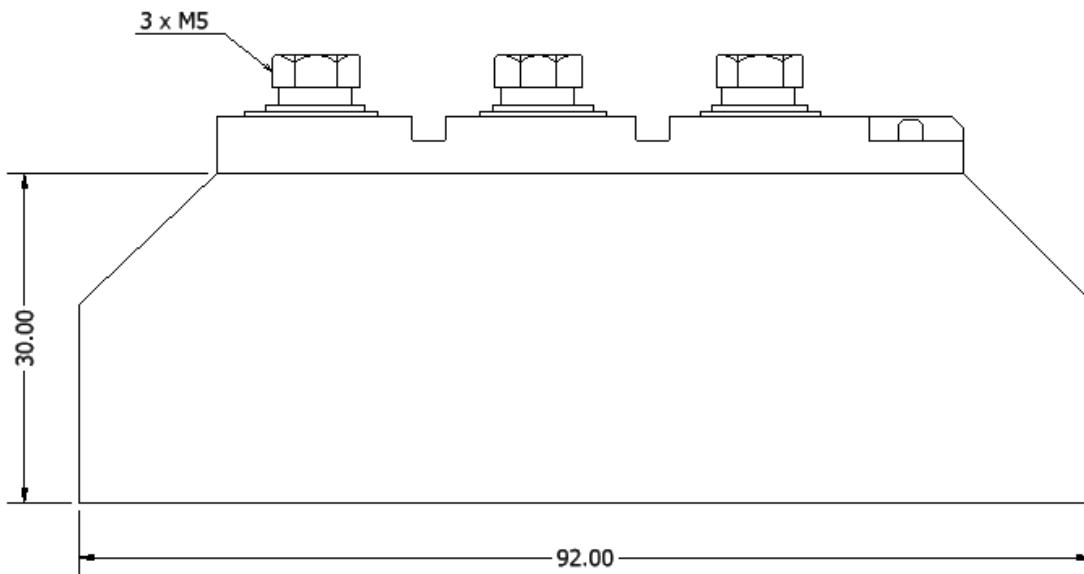
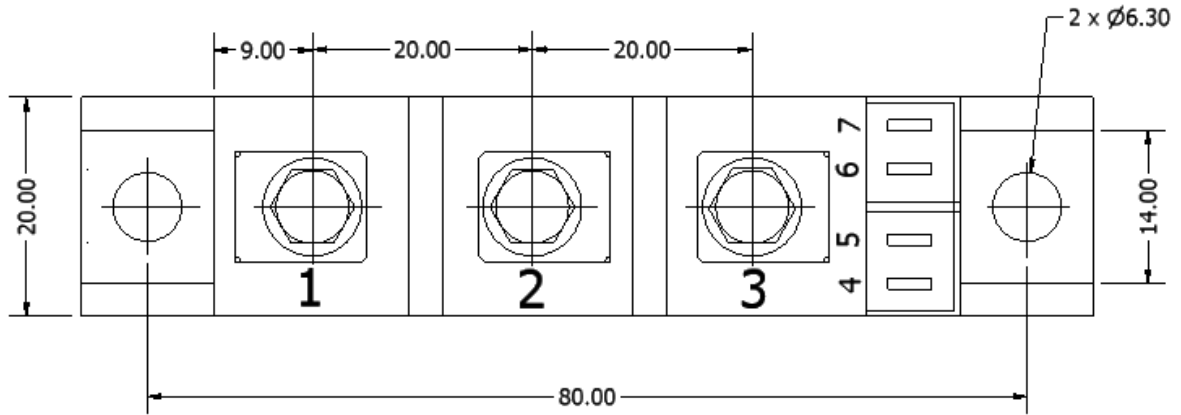

ALL DIMENSIONS ARE IN MM

Diode Configuration

