

Single Phase Bridge Rectifier

Features

- Glass passivated chip junction
- Surge capability of 400 A
- High efficiency
- Electrically isolated metal case for maximum heat dissipation
- Mounting: thru hole for # 8 screw

Thermal and Mechanical Specifications ($T_A = 25^{\circ}\text{C}$ unless otherwise noted)			
Parameters	Symbol	Values	Units
Maximum operating junction temperature range	T_J	- 55 to + 125	$^{\circ}\text{C}$
Maximum storage temperature range	T_{Stg}	- 55 to + 150	$^{\circ}\text{C}$
Approximate weight	W_T	30	g



GBPC

Voltage Ratings ($T_A = 25^{\circ}\text{C}$ unless otherwise noted)										
Parameter	Symbol	35MB							Units	
Maximum repetitive peak reverse voltage	V_{RRM}	50	100	200	400	600	800	1000	V	
Maximum RMS voltage	V_{RMS}	35	70	140	280	420	560	700	V	
Maximum DC blocking voltage	V_{DC}	50	100	200	400	600	800	1000	V	
Maximum average forward output current	$I_{F(AV)}$	35.0							A	
Peak forward surge current (10ms) single half sine-wave superimposed on rated load	I_{FSM}	400							A	
Maximum DC forward voltage drop per element @ 7.5 A	V_F	1.2							V	
Maximum DC reverse current at rated DC blocking voltage per element	$T_A = 25^{\circ}\text{C}$	I_R	5.0							μA
	$T_A = 125^{\circ}\text{C}$		500							

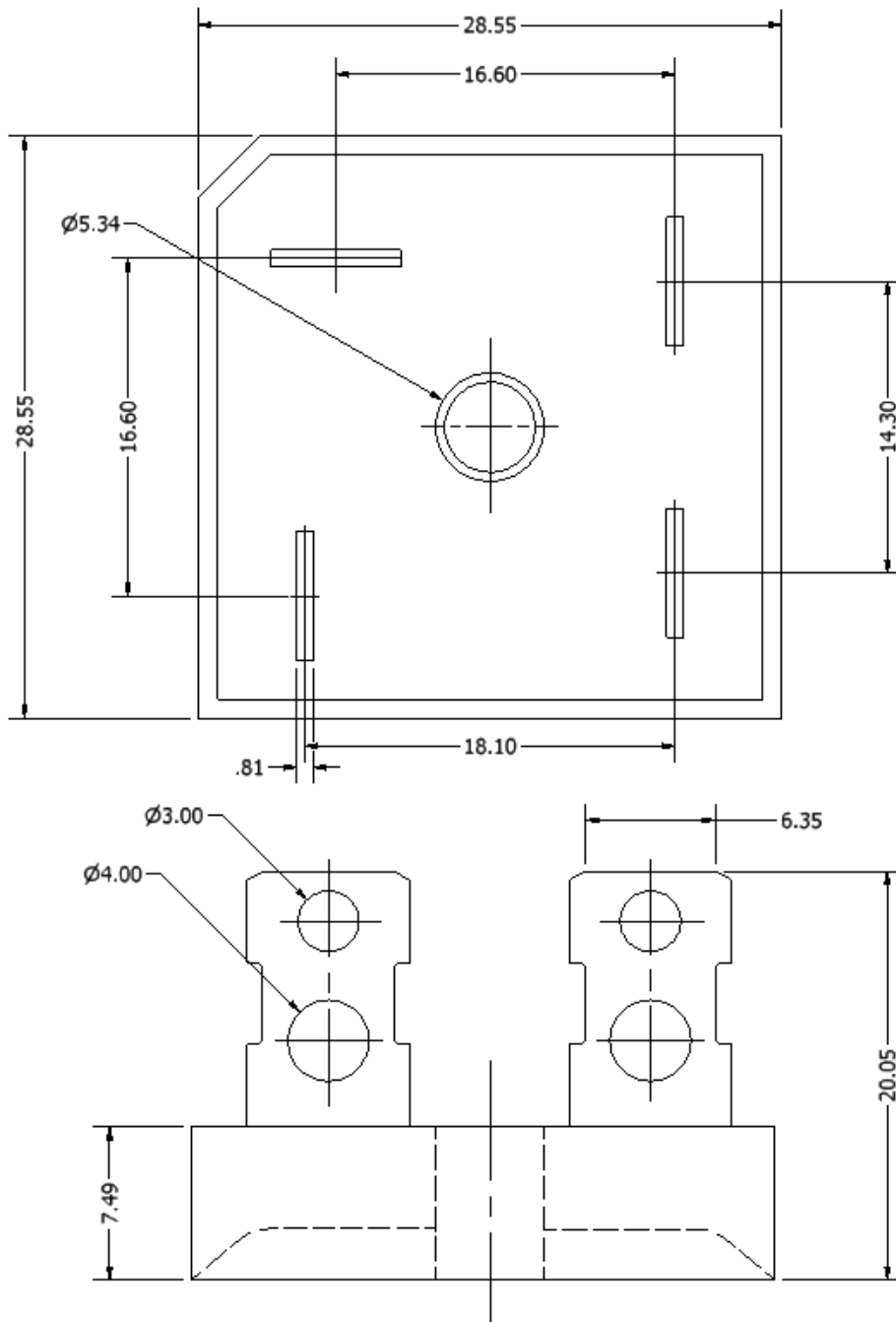

ALL DIMENSIONS ARE IN MM