

ASSP

ISO/IEC 15693 Compliant FRAM Embedded

High-speed RFID LSI *FerVID family*TM

MB89R119B

■ DESCRIPTION

The MB89R119B is a vicinity type of RFID LSI device embedded with 256 bytes FRAM, which enables fast and frequent write operation.

■ FEATURES

- 256 bytes FRAM memory (232 bytes of user area)
- 4-byte/block configuration, 64 blocks
- High-speed data transmission and reception at 26.48 kbps
- Fast command supported (data transmission at 52.97 kbps) (MB89R119B → Reader/Writer)
- Carrier frequency at 13.56 MHz
- Anti-collision function : 40 tags per second (when using ASK 100%)
- Read/Write endurance : 10^{12} times
- Data Retention : 10 years (+ 85 °C)
- 64-bit Unique Identifier (UID)
- FRAM memory data protection
- Electronic Article Surveillance (EAS) command supported
- Kill command (to disable communication eternally) supported
- Compliance with ISO/IEC 15693 (partly not supported*)
- Compliance with ISO/IEC 18000-3 (Mode 1) (partly not supported*)

* : Refer to “■ NOTES ON USING”.

Note: FerVID family is a trademark of Fujitsu Semiconductor Limited, Japan.

MB89R119B

■ BLOCK DIAGRAM

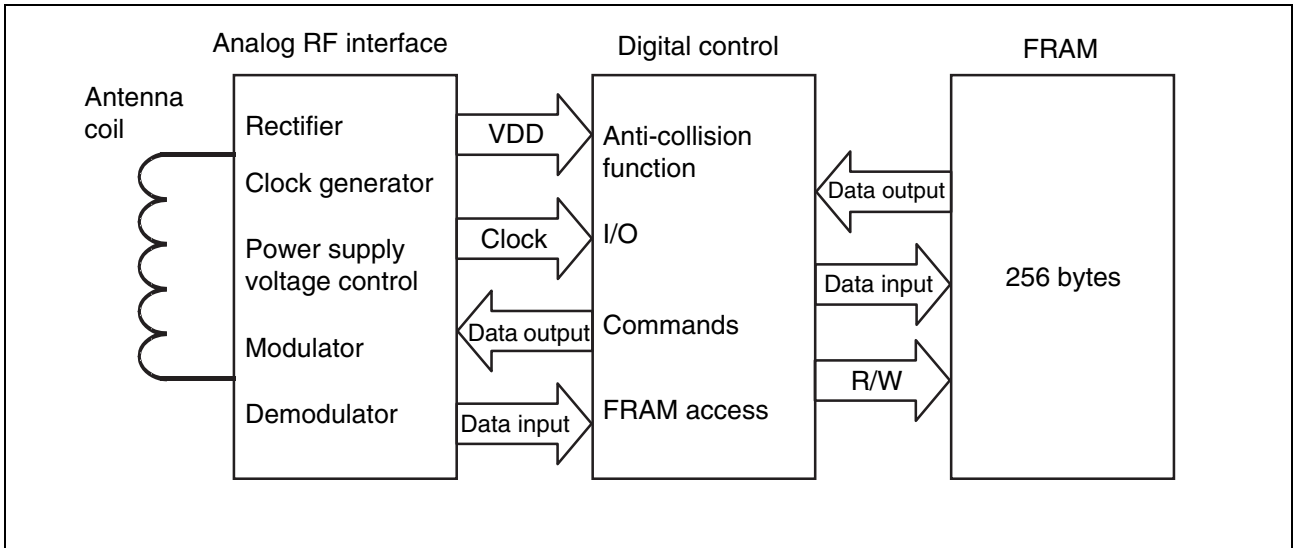

■ MEMORY CONFIGURATION

This section describes the FRAM memory, which is the internal memory of the MB89R119B.

• FRAM Configuration

The FRAM has 232 bytes for use as user area and 24 bytes for use as system area.

The FRAM memory areas consist of a total of 64 blocks (58 blocks of user area and 6 blocks of system area). Each block can store 32 bits (4 bytes) of data.

The block is the unit used for the writing and reading of FRAM data. The memory configuration of the FRAM is shown below.

• FRAM memory configuration

Area	Block No.	Details	Data read	Data write
User area (232 bytes)	00 _H to 39 _H	User area	Yes	Yes
System area (24 bytes)	3A _H	RFU*	Yes	No
	3B _H	UID1 (1 to 32 bit)	Yes	No
	3C _H	UID2 (33 to 64 bit)	Yes	No
	3D _H	EAS, AFI, DSFID, IC Reference	Yes	Limited
	3E _H ,3F _H	Block security status	Yes	No

* : Reserved for future use

Blocks “00_H” to “39_H” are user area. The user area is defined as an accessible area when the corresponding block address is specified. On the other hands, Blocks “3A_H” to “3F_H” are system area. The system area is defined as an accessible area only with a specific command.

The system area consists of 6 blocks and contains RFU, UID, AFI, DSFID, EAS, IC reference and security status (can write or cannot write data). UID, IC reference and RFU are fixed and cannot be updated. The initial data of AFI, DSFID, and EAS are written at the factory, and they can be updated and locked (disable to write) with commands (EAS bit cannot be locked) .

As shown in above, “3B_H” and “3C_H” are used to store the UID data, and “3E_H” and “3F_H” are used to store the security status information such as user areas, AFI, and DSFID.

“3D_H” to “3F_H” block format is shown as follows. “3D_H” block contains EAS bit, AFI, DSFID and IC reference. “3E_H” and “3F_H” blocks contain block security status data.

• “3D_H” block format

MSB				LSB				
32	31	25	24	17	16	9	8	1
EAS Bit		Internally used		IC Reference		DSFID		AFI

MB89R119B

- “3E_H” and “3F_H” block format

		MSB			LSB		
		32	31	• • •	26	• • •	1
3E _H	Block security status (BSS) of user block 1F _H	• • •					BSS of 00 _H
3F _H	AFI Lock Status	DSFID Lock Status	RFU* (4 bits)	BSS of 39 _H	• • •	BSS of 20 _H	

* : Reserved for future use

The security status of the user area is stored in the block security status bit in system area blocks of “3E_H” and “3F_H” per bit in each block. A user area is unlocked when the corresponding block security status bit is “0”; it is locked (disable to write state) when the corresponding block security status bit is “1”. In the same way, data in the security status of AFI and DSFID are stored in “AFI Lock Status” and “DSFID Lock Status” respectively.

The EAS bit is 1 bit, and it is used for setting EAS status.

It is possible to read up to 64 blocks data by one command and to write up to 2 blocks data by one command.

■ DATA ELEMENT DEFINITION

1. Unique Identifier (UID)

The MB89R119B has a 64-bit unique identifier (UID) that complies with ISO/IEC 15693-3. The UID is used to distinguish a transponder from another transponder in the anti-collision algorithm.

The UID consists of the 3 items shown in the following.

- The MSB 8-bit data whose value is always "E0_H" (bit 57 to bit 64)
- An 8-bit IC manufacturer code whose value is always "08_H" according to ISO/IEC 7816-6/AMI (bit 49 to bit 56)
- Unique 48-bit serial number assigned by Fujitsu Semiconductor (bit 1 to bit 48)

Among the unique 48-bit serial number assigned by Fujitsu Semiconductor, the 1 byte from bit 41 to bit 48 defines MB89R119B code whose value is "02_H". And the 5 bytes from bit 1 to bit 40 define Chip Information.

- UID format

MSB						LSB	
64	57	56	49	48	41	40	1
"E0 _H "		IC manufacturer code "08 _H "		"02 _H "		Chip information	
Unique serial number assigned by Fujitsu Semiconductor							

2. Application Family Identifier (AFI)

The application family identifier (AFI) represents the type of application set by the transponder.

The AFI can be written with a command. The AFI is 8-bit data and is stored in the system area of memory (FRAM).

The initial data of the AFI is "00H".

• Types of AFI

Application Family (bit 8 to bit 5)	Application Sub-Family (bit 4 to bit 1)	Application Field	Example/Note
"0"	"0"	All families and sub-families	No application preselection
X	"0"	All sub-families of family X	Wide applicative preselection
X	Y	Only the Yth sub-families of family X	
"0"	Y	All families of Yth sub-families	
"1"	"0", Y	Transport	Mass transit, bus, airline
"2"	"0", Y	Financial	IEP, banking, retail
"3"	"0", Y	Identification	Access control
"4"	"0", Y	Telecommunication	Public telephone, GSM
"5"	"0", Y	Medical	
"6"	"0", Y	Multimedia	Internet services
"7"	"0", Y	Gaming	
"8"	"0", Y	Data storage	Portable files
"9"	"0", Y	EAN-UCC system for application identifiers	Managed by ISO/IEC JTC1/SC31
"A"	"0", Y	ISO/IEC JTC1/SC31	Data identifiers as defined in ISO/IEC 15418
"B"	"0", Y	IATA	Managed by ISO/IEC JTC1/SC31
"C"	"0", Y	UPU	Managed by ISO/IEC JTC1/SC31
"D"	"0", Y	RFU*	Managed by ISO/IEC JTC1/SC31
"E"	"0", Y	RFU*	Managed by ISO/IEC JTC1/SC31
"F"	"0", Y	RFU*	Managed by ISO/IEC JTC1/SC31

* : Reserved for future use

Note : Both X value and Y value are "1" to "F".

In the status of the AFI_flag (bit 5) setting;

- If the AFI is not supported by the transponder, no response to all requests is returned.
- If the AFI is supported by the transponder, the response is returned only if the value is in accord with the AFI sent from a reader/writer.

3. Data Storage Format Identifier (DSFID)

The data storage format identifier (DSFID) indicates how data is structured in the transponder (LSI memory device). The DSFID can be written with a command.

The DSFID is 8-bit data and is stored in the system area of memory (FRAM). The initial data of the DSFID is "01H".

4. Cyclic Redundancy Check (CRC)

Upon reception of a request from the reader/writer, the transponder shall verify that CRC value is valid. If it is invalid, it shall discard the frame and shall not answer.

Upon reception of a response from the transponder, the reader/writer is recommended that the reader/writer verify that the CRC value is valid. If it is invalid, actions to be performed are left to the responsibility of the reader/writer maker. For error-checking, the 2 bytes CRC are appended to each request and each response, with each frame, before the EOF.

The CRC is calculated on all the bytes after the SOF up to but not including the CRC field. Method of calculation is provided in ISO/IEC 13239 and the detail is defined in ISO/IEC 15693-3 and ISO/IEC 18000-3 (Mode 1) . The initial value of the CRC code provided in ISO/IEC 15693-3 is "FFFF_H".

The CRC code is transferred, beginning with the least significant bit in the least significant byte.

- CRC bit/bytes transmission rules

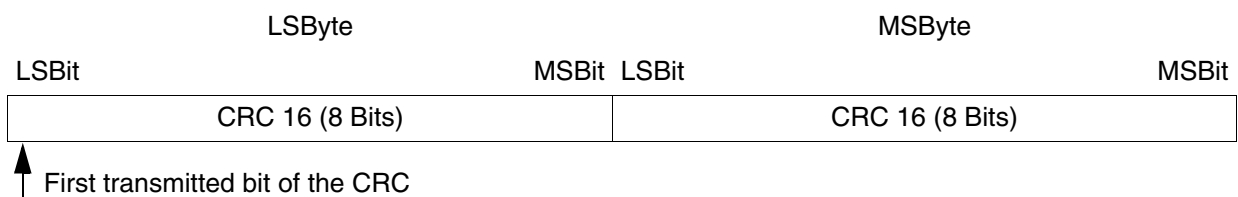

5. Electronic Article Surveillance (EAS) status

EAS status is 1 bit data, which is stored in the system area of memory (FRAM) . The initial value is "1". EAS bit "1" means goods-monitoring status, and EAS bit "0" means that goods-monitoring status is cleared. EAS status can be written by Write EAS command and can be checked "3D_H" block (refer to "■ MEMORY CONFIGURATION") by Read commands such as Read Signal Block command.

Together with Gate type reader/writer, EAS command can support anti-theft security functions.

■ FUNCTION DESCRIPTION

1. Communications Signal Interface Reader/Writer to Transponder

1-1. Modulation

MB89R119B 10% ASK modulation and 100% ASK modulation are supported.

Modulation index m is defined as $m = (a - b)/(a + b)$ with reference to the modulated waveform shown below.

The values a and b indicate, respectively, the maximum and minimum amplitude of magnetic field transmitted from a reader/writer.

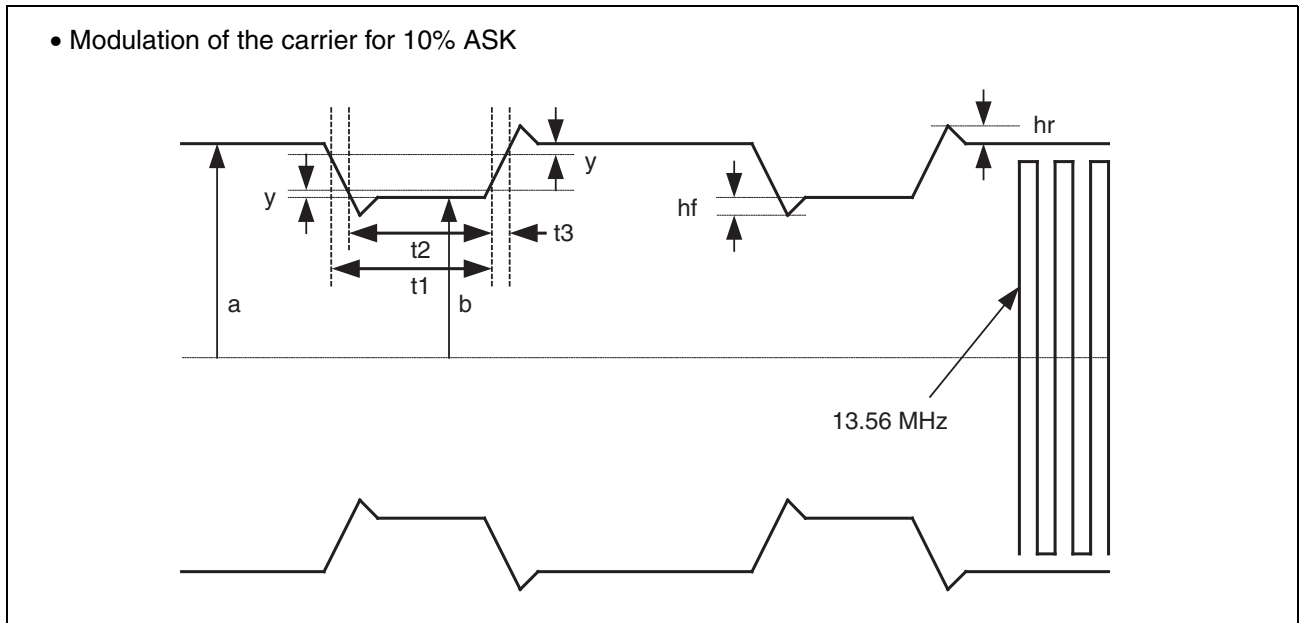

• Modulation of the carrier for 100% ASK

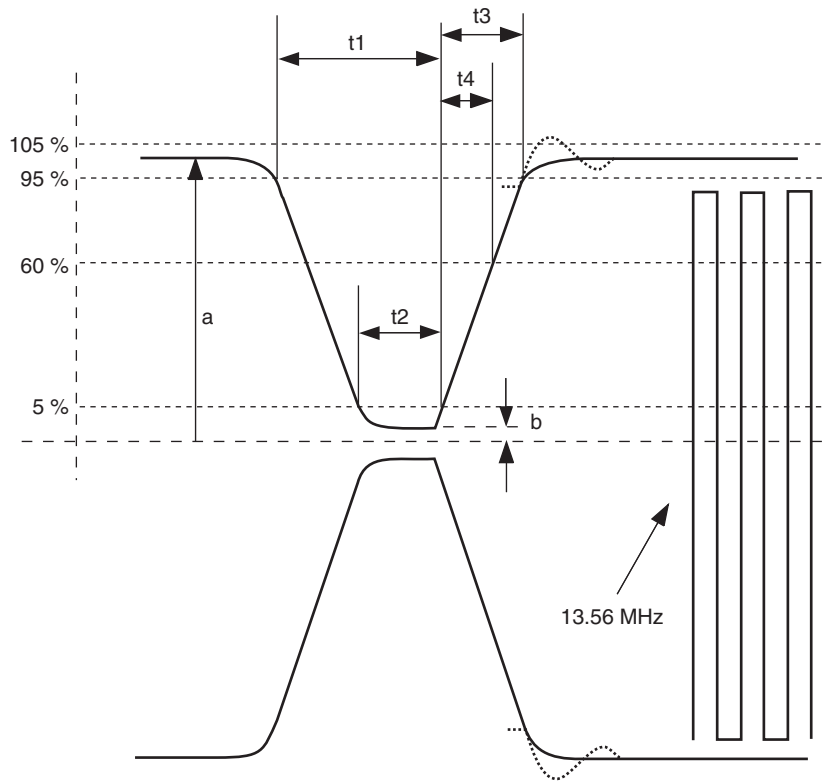

Maximum and minimum values of t_1 , t_2 and t_3 are specified in "■ RECOMMENDED OPERATION CONDITIONS". y is 0.05 ($a-b$) and the maximum value of hf and hr is 0.1($a-b$).

1-2. Data rate and data coding

The MB89R119B supports only 1-out-of-4 mode for data coding (Not supports 1-out-of-256 mode) . In 1-out-of-4 mode, 2-bit signals are coded in a period of 75.52 μs as shown in the following. The resulting data rate is 26.48 kbps($f_c/512$). Each signal is transmitted beginning with the least bit.

- In 1-out-of-4 coding Mode

- “00_B” pulse position

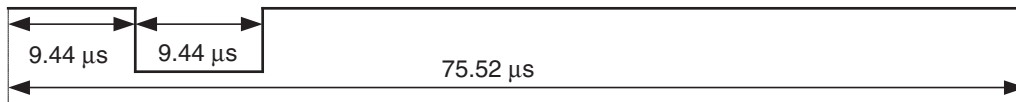

- “01_B” pulse position (1 = LSB)

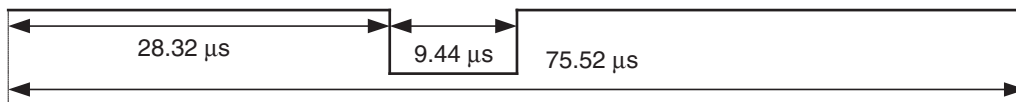

- “10_B” pulse position (0 = LSB)

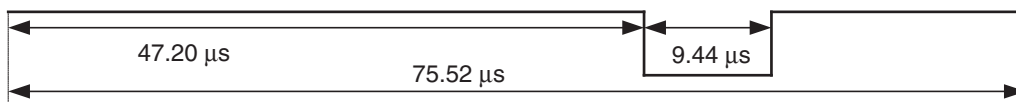

- “11_B” pulse position

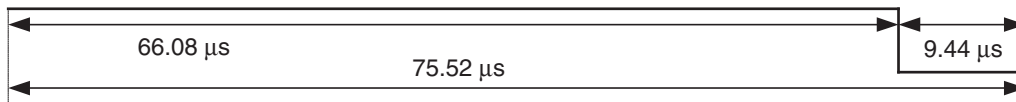

1-3. Data frame

Frames shall be delimited by a start of frame (SOF) and an end of frame (EOF) and are implemented using code violation. The MB89R119B shall be ready to receive a frame from a reader/writer within 300 μs after the MB89R119B has sent a frame to the reader/writer. The MB89R119B shall be ready to receive a frame from a reader/writer within 3 ms of activation by the powering field.

- Waveforms of SOF and EOF signals of a frame sent from a reader/writer

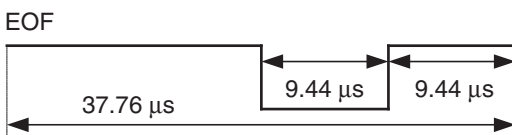
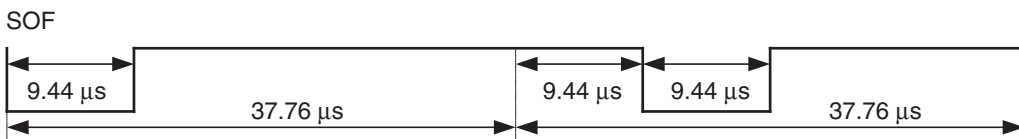

2. Communications Signal Interface Transponder to Reader/Writer

- Minimum load modulation amplitude (V_{lm}) : 10 mV (based on ISO/IEC 10373-7)
- Load modulation subcarrier frequency (f_s) : 423.75 kHz(fc/32)

The MB89R119B supports only a 1-subcarrier system.
(Not supports 2-subcarrier system.)

- Data rate : The MB89R119B supports the following 2 data rate modes :
 - Low data rate
 - High data rate

One of the 2 data rate modes is specified by the Data_rate_flag (bit 2) (described later) sent from the reader/writer. In low data rate mode, the data rate is 6.62 kbps (fc/2048); in high data rate mode, it is 26.48 kbps (fc/512).

When receiving the Fast commands (Custom commands) , the communication starts from the transponder in the data rate that is twice as fast as normal data rate. In this case, the Fast commands (Custom commands) supports the 2 data rate modes specified by the Data_rate_flag (bit 2). In Low data rate mode, the data rate is 13.24 kbps (fc/1024) ; in high data rate mode, it is 52.97 kbps (fc/256)

2-1.Bit coding

The Manchester coding is used for the bit coding. The following figure shows the signals modulated in high data rate mode when ISO command is received, and the next following figure shows the same signals when fast command is received. For the low data rate, both ISO command and fast command, the same subcarrier frequency is used, in this case the number of pulse and the timing shall be multiplied by 4.

- Signal waveforms by load modulation in high data rate mode (ISO commands)

- Logic 0

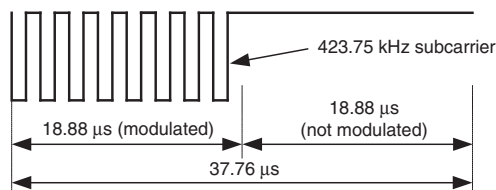

- Logic 1

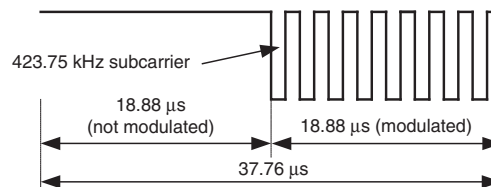

- Signal waveforms by load modulation in high data rate response mode (fast commands)

- Logic 0

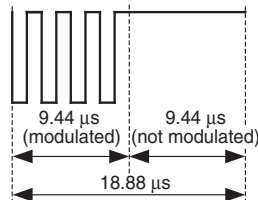

- Logic 1

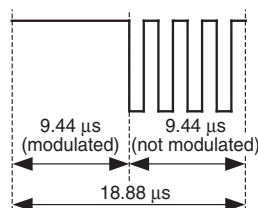

2-2.Data frame

Frames are delimited by a start of frame (SOF) and an end of frame (EOF) and implemented using code violation. The following figure shows the SOF and EOF signals sent in high data rate mode when ISO command is received, and the next following figure shows the same signals when fast command is received.

For the low data rate, both ISO command and fast command, the same subcarrier frequency is used, in this case the number of pulses and the timing shall be multiplied by 4.

The reader/writer shall be ready to receive a frame from the transponder within 300 μs after having sent a frame to the transponder.

- Waveforms of SOF and EOF signals of a frame sent from a transponder (ISO commands)

- SOF



- EOF



- Waveforms of SOF and EOF signals of a frame sent from a transponder (fast commands)

- SOF

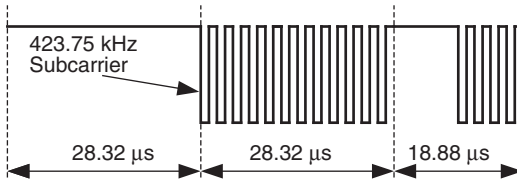

- EOF

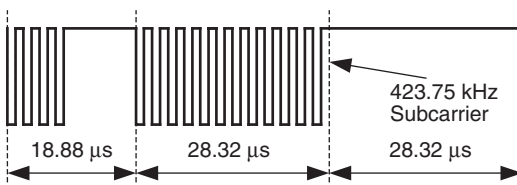

3. FRAM Data Protection from RF Power Shutdown during Accessing FRAM

MB89R119B accesses to FRAM with the unit of 1 byte. When RF power is shut down during accessing FRAM, writing in FRAM is completed by the charges stored in a smoothing capacitor on the LSI and FRAM data writing error is prevented.

Therefore, the commands of 1 byte access such as Write AFI, Write DSFID, Write EAS, and Lock command can protect the data from the power down.

On the other hands, the commands of more than 2 bytes access such as Write Single Block command may not protect all the data from the power down during the access. In this case, it is recommended to confirm the data by read command if it's written correctly.

4. Requests/Responses

A request is sent from the reader/writer to the transponder. In reply to the request, the transponder sends a response to the reader/writer.

Request, and response, are transmitted in a single frame.

- Structure of requests and responses

Each request consists of the following fields :

- Flags
- Command code
- Parameter (required or optional depending on the command)
- Application data fields
- CRC

Each response consists of the following field :

- Flags
- Parameter (required or option depending on the command)
- Application data fields
- CRC

A multiple byte field is transmitted least significant byte (LS Byte) first, each byte is transmitted least significant bit (LS Bit) first.

5. Operating Modes

The MB89R119B has the following 3 operating modes :

The term mode refers to the mechanism to specify in a request the set of reader/writer that shall answer to the request :

- Addressed mode

When the Address_flag is set to "1", the request shall contain the unique ID (UID) of the addressed MB89R119B. Any MB89R119B receiving a request with Address_flag set to "1" shall compare the UID to its own ID. If it matches, it shall execute it and return a response to the VCD as specified by the command description. If it does not match, it shall remain silent.

- Non-Addressed mode

When the Address_flag is set to "0", the request shall not contain a UID. Any MB89R119B receiving a request with the Address_flag (bit 6) set to "0" shall execute it and shall return a response to the reader/writer as specified by the command description.

- Select mode

The MB89R119B enters select mode when the Select_flag is set to "1", and the Address_flag is set to "0".

In select mode, do not include a UID as a request. Of the transponders that receive the command, only the transponder in the select state executes processing and returns a response in accordance with the command in the request.

6. Request Format

Figure shows a typical example of the request data format, and Table shows the definition of request flag bits.

- Structure of the request frame

SOF	Flags	Command code	Parameters	Data	CRC	EOF
-----	-------	--------------	------------	------	-----	-----

- Request flags bit 1 to bit 4 definition

Bit	Flag name	Value	State/Description
1	Sub-carrier_flag	0	One subcarrier selected
		1	Two subcarriers selected (not supported)
2	Data_rate_flag	0	Low data rate (6.62 kbps) selected
		1	High data rate (26.48 kbps) selected
3	Inventory_flag	0	Command other than Inventory command selected
		1	Inventory command selected
4	Protocol_Extension_flag	0	Protocol not extended
		1	Protocol extended (not supported)

Note : “Inventory_flag” of bit3 is determined whether “Inventory command” (select “1”) or other command (select “0”) is used.

- Request flags bit 5 to bit 8 definition (When Inventory command is selected [Inventory_flag = “1”])

Bit	Flag name	Value	State/Description
5	AFI_flag	0	AFI not set
		1	AFI set (response when it is in accord with AFI of the transponder)
6	Nb_slots_flag	0	16-slots (for one or more transponders)
		1	1-slot (for one transponder)
7	Option_flag	0	Command option not supported
		1	Command option supported (not supported)
8	RFU*	0	Set to “0”
		1	—

* : Reserved for future use

- Request flags bit 5 to bit 8 definition (When the command other than Inventory command is selected [Inventory_flag = "0"])

Bit	Flag name	Value	State/Description
5	Select_flag	0	Command flag decided by the setting of bit 6 and later bits.
		1	Select mode (the response is sent by only the transponder in select state)
6	Address_flag	0	Non addressed mode (UID not included in the command)
		1	Addressed mode (UID included in the command)
7	Option_flag	0	Command option not supported (for the command not supporting the Option_flag)
		1	Command option supported
8	RFU*	0	Set to "0"
		1	—

* : Reserved for future use

7. Response Format

Figure shows a typical example of the response data format, and table shows the definition of the response flag bits and error codes.

If the Error_flag (bit 1) is set to "1", an error code field is generated in the response. If the Error_flag is set to "0", this means no error, and If the Error_flag is set to "1", this means any error generation.

- Structure of the response frame

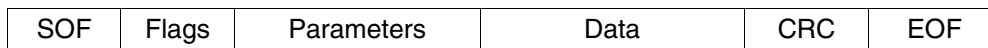

- Response flags 1 to 8 definitions

Bit	Flag name	Value	Description
1	Error_flag	0	No error
		1	Error detected
2	RFU*	0	Set to "0"
3	RFU*	0	Set to "0"
4	Extension_flag	0	Set to "0"
5	RFU*	0	Set to "0"
6	RFU*	0	Set to "0"
7	RFU*	0	Set to "0"
8	RFU*	0	Set to "0"

* : Reserved for future use

- Response Error code definitions

Error code	Meaning
"01"	The command is not supported. Example: Command code error
"02"	The command is not recognized. Example: Format error
"03"	The command option is not supported.
"10"	The specified block is not available (does not exist).
"11"	The specified block is already locked and thus cannot be locked again.
"12"	The specified block is already locked, and its contents cannot be changed.
"13"	The specified block was not successfully programmed (a write verify error occurred).
"14"	The specified block was not successfully locked (a lock verify error occurred).

8. Anti-Collision Algorithm

The MB89R119B executes an anti-collision sequence loop based on an algorithm that complies with ISO/IEC 15693-3.

The purpose of the anti-collision sequence is to make an inventory of the transponders present in the reader/writer field by their unique ID (UID).

The reader/writer issues an Inventory command to transponders, and some transponders return responses while other transponders do not according to the algorithm explained in "10. Execution of Inventory Command by a Transponder".

9. REQUEST PARAMETER

- Request Parameter Settings

Set the reader/writer as follows before issuing the Inventory command.

- The Nb_slots_flag (bit6), which is a request flag, is set to the desired value :
 - "0" : 16 slots (for plural transponders)
 - "1" : 1 slot (for single transponder)
- A mask length and a mask value are added after the command code.
- The mask length indicates the significant bits of the mask value.
- The mask value is integer bytes of data, transmitted beginning with the least bit. If the mask length is not a multiple of 8 (bits), 0 is padded on the MSB side of the mask value so that the data is in units of bytes.

The following figure shows an example of the mask value with padding. Since the mask length is 12 bits, the mask value is padded with 4 bits on the MSB side so that the mask data is in units of bytes (2 bytes = 16 bits in this case).

If the AFI_flag (bit 5) in the request flags is set in the format explained in "6. Request Format", an AFI field is added to the format. The command ends with transmission of an EOF signal as described in "1. Communication from Reader/Writer to Transponder". Thereafter, processing in the first slot starts immediately. To proceed to the next slot, the reader/writer sends an EOF signal.

- Format of the Command

SOF	Flags	Command code	Optional AFI	Mask length	Mask value	CRC	EOF
	8 bits	8 bits	8 bits	8 bits	0 to 64 bits	16 bits	

- Example of the padding of the mask

MSB	LSB
0000	0100 1100 1111
Pad	Mask value

10. Execution of Inventory Command by a Transponder

A transponder returns a response to the reader/writer when its UID is equal to the value that consists of the mask value and the number of slots. The mask value is sent in the Inventory command, and the number of slots is determined by the number of times the EOF signal is transmitted.

- Algorithm for execution of processing by a transponder

The following figure shows the algorithm for the execution of processing by a transponder when an Inventory command is received. The next page shows the relationship between the UID and the mask value.

- Algorithm for Execution of Processing by a Transponder when Inventory Command

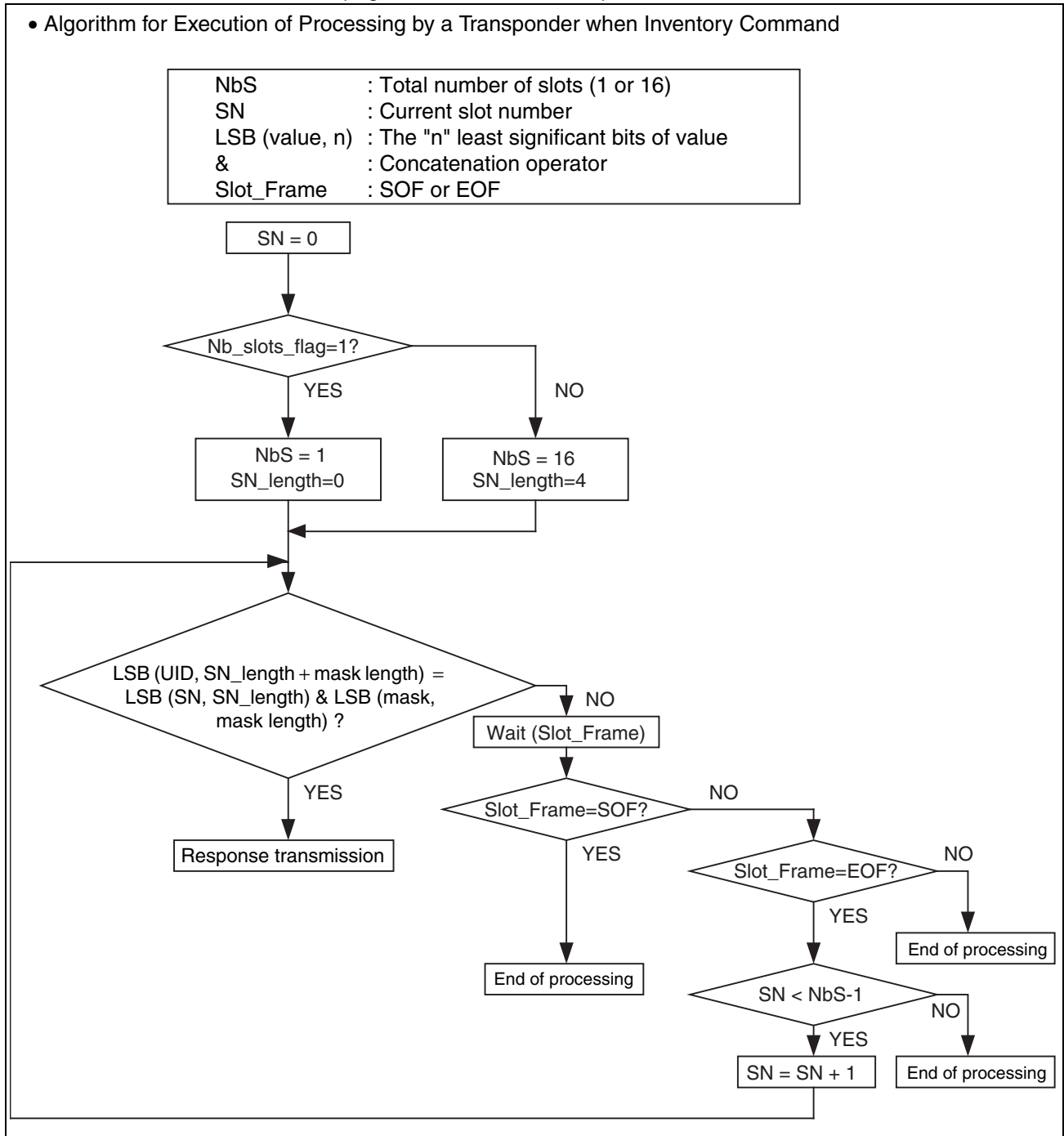

- Principle of comparison between the mask value, slot number and UID

Inventory command includes the mask value and mask length.
The mask value is padded with "0" to a whole number of bytes (a multiple of 8 bits).

If Inventory command is received, the slot counter is reset to "0".

If EOF is received, the increment of the slot counter is started by the transponder.

The value is compared with the least significant bits of UID of the transponder.
If the value is in accord with the mask value, the response is returned by the transponder.

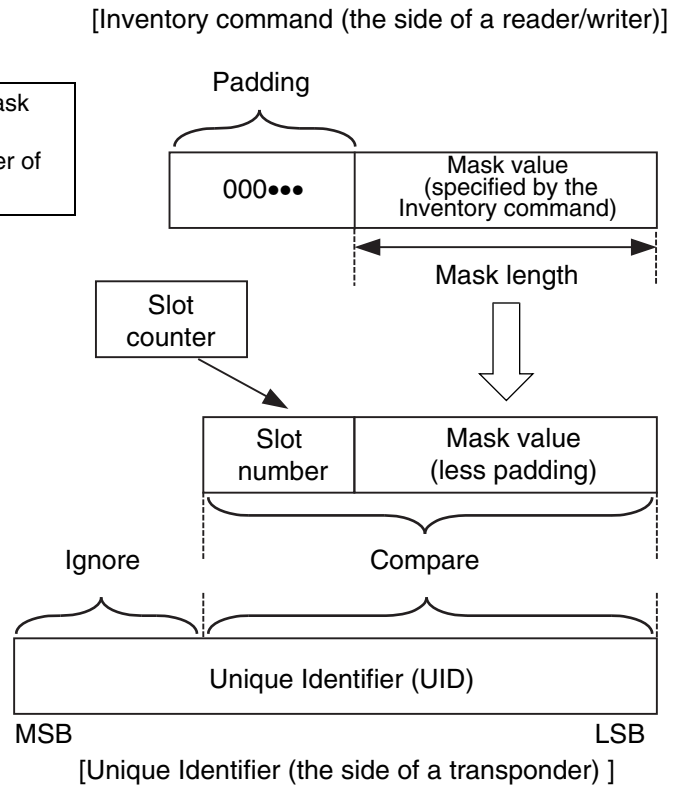

11. Anti-Collision Sequence

- Execution of anti-collision sequence

A typical anti-collision sequence that is applied when the number of slots is 16 is executed as follows :

- (1) The reader/writer sends an Inventory command. The Nb_slots_flag of the request flags is set to "0" to specify the number of slots.
- (2) In slot 0, transponder 1 transmits its response in the time t1_a from the detection of the rising edge of the EOF. In this case no collision occurs and the UID of transponder is received and registered by the reader/writer.
- (3) The reader/writer sends an EOF signal to switch to the next slot in the time t2_a after the response 1.
- (4) In slot 1, transponder 2 and transponder 3 transmit its response in the time t1_a from the detection of the rising edge of the EOF. In this case, the reader/writer cannot recognize the UIDs of the two transponders because the collision occurs, and the reader/writer remembers that a collision was detected in slot 1.
- (5) The reader/writer sends an EOF signal to switch to the next slot in the time t2_a after the responses.
- (6) In slot 2, no transponder transmits a response. The reader/writer does not detect any response, and sends an EOF signal to switch to the next slot in the time t3_a from the detection of the rising edge of the EOF.
- (7) In slot 3, transponder 4 and transponder 5 transmit its response in the time t1_a from the detection of the rising edge of the EOF, and another collision occurs.
- (8) The reader/writer sends a request (for example, a Read Single Block command, described later) to the transponder 1, which UID was already correctly received.
- (9) All transponders detect an SOF signal and exit the anti-collision sequence. In this case, since the request is addressed to transponder 1 (Address Mode), only transponder 1 transmits its response.
- (10) All transponders are ready to receive another request from the reader/writer. If the Inventory command is sent again, the anti-collision sequence starts from slot 0.

Note: t1_a, t2_a, t3_a are specified in clause 12.

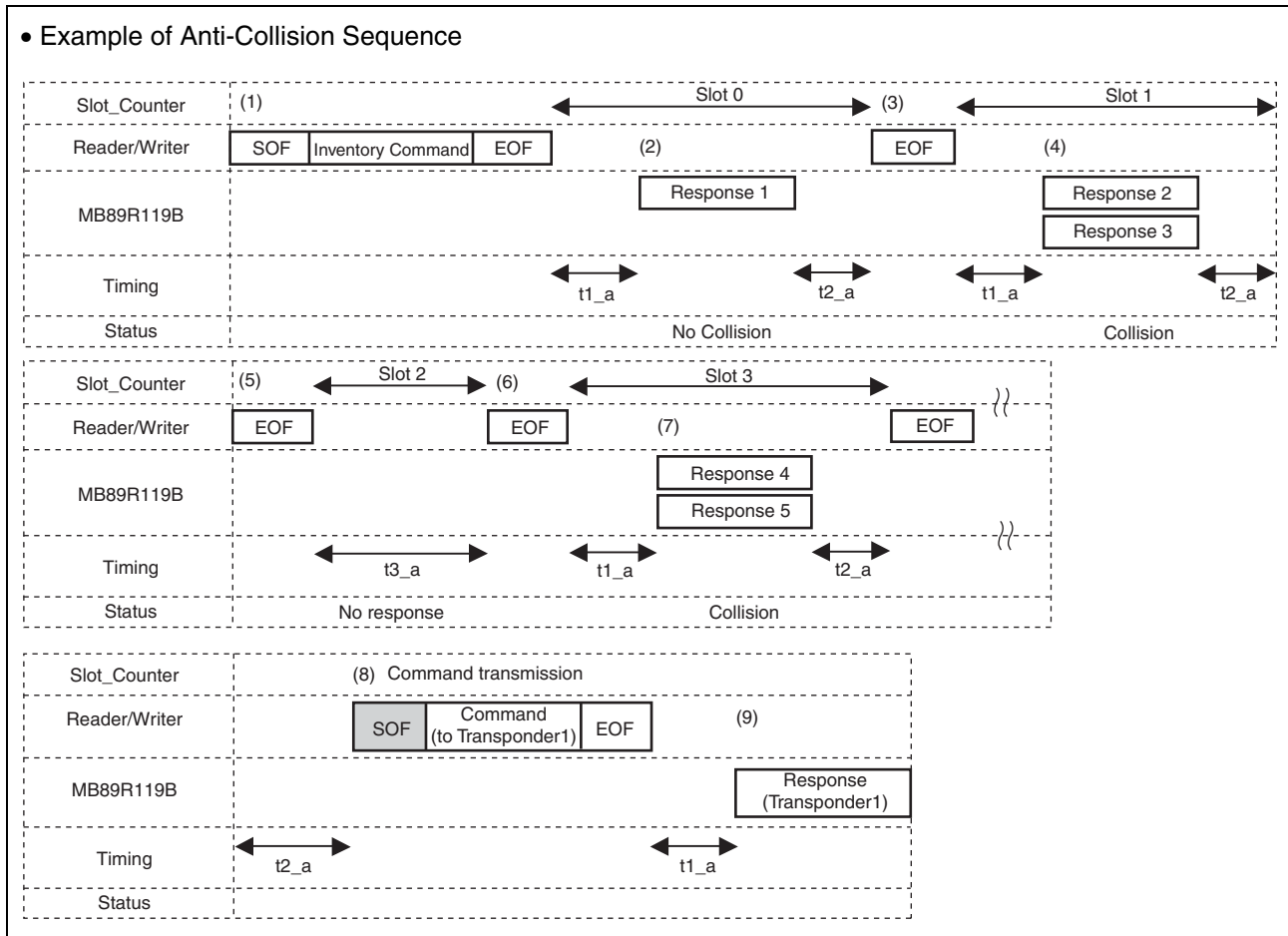

12. Timing definitions

- (1) Transponder waiting time before transmitting its response after reception of an EOF from the reader/writer : $t1_a$

After detection of an EOF signal sent from the reader/writer, each transponder must wait for a certain time ($t1_a$) before sending a response to the reader/writer. $t1_a$ begins at the rising edge of the EOF pulse, and it is defined as following. The minimum value is $4320/fc$ ($= 318.6 \mu s$), the nominal value is $4352/fc$ ($= 320.9 \mu s$), and the maximum value is $4384/fc$ ($= 323.3 \mu s$).

If the transponder detects a carrier modulation for ASK 100% or 10% within the time $t1_a$, it shall reset its $t1_a$ timer and wait for further time $t1_a$ before starting to transmit its response to a reader/writer.

MB89R119B defines the same waiting time $t1_a$ for Write commands as followings, although the maximum value is not defined in ISO/IEC 15693-3 and ISO/IEC 18000-3 (Mode 1) . The minimum value is $4320/fc$ ($= 318.6 \mu s$), the nominal value is $4352/fc$ ($= 320.9 \mu s$), and the maximum value is $4384/fc$ ($= 323.3 \mu s$). Timing conditions for Write command in which the option_flag is "1", has optional field are defined in the command descriptions.

- (2) Transponder modulation ignore time after reception of an EOF from the reader/writer : $tmit$

After detection of an EOF signal sent from the reader/writer, MB89R119B shall ignore any received 10% modulation during $tmit$. $tmit$ starts from the detection of the rising edge of the EOF, and the minimum value is defined as $4384/fc$ ($= 323.3 \mu s$) + $tnrt$. $tnrt$ stands for the response time of MB89R119B.

- (3) Reader/writer waiting time before sending a subsequent request : $t2_a$

When the reader/writer has received a response from the transponder to a previous request other than Inventory and Quiet command, it shall wait a time $t2_a$ before sending a subsequent request. The minimum value of $t2_a$ is $309.2 \mu s$. It is defined in ISO/IEC 15693-3 and ISO/IEC 18000-3 (Mode 1) .

When the reader/writer has sent Stay Quiet command or Kill command, which causes no response from the transponder, or MB89R119B does not return any response, MB89R119B can receive a command in $309.2 \mu s$ from the detection of the rising edge of the EOF.

- (4) Reader/writer waiting time before sending a request (switching to the next slot) during an Inventory process : $t2inv$

During Inventory process, the reader/writer sends an EOF to switch to the next slot. In this case, the waiting time is defined as follows depending on whether transponders return responses.

- Waiting time applied when the reader/writer has received one or more responses : $t2invwr$
It is defined in ISO/IEC 15693-3 and ISO/IEC 18000-3 (Mode 1) that when the reader/writer has received one or more responses, the reader/writer must wait until responses from the transponders have been completed (that is, the reader/writer receives an EOF or $tnrt$ passes). After that, the reader/writer must wait as additional $t2_a$, and then send a 10% or 100% ASK modulated EOF to switch to the next slot.
- Waiting time applied for when the reader/writer has not received any responses : $t3_a$
When the reader/writer has not received any responses from the transponders, the reader/writer must wait until $t3_a$ passes before sending an EOF signal. In this case, $t3_a$ starts from the rising edge of the last sent EOF. The minimum value of $t3_a$ is defined as shown in the following table.
 - (a) If the reader/writer sends a ASK10% modulated EOF,
the minimum value of $t3_a$ (ASK 10%) is ' $4384/fc$ ($= 323.3 \mu s$) + $tnrt$ '.
 - (b) If the reader/writer sends a ASK100% modulated EOF,
the minimum value of $t3_a$ (ASK 100%) is ' $4384/fc$ ($= 323.3 \mu s$) + $tsof$ '.

$tnrt$: The nominal response time of transponder

$tsof$: The time for transponder to transmit a SOF to the reader/writer

• t3_a for ASK10% and ASK100% signal

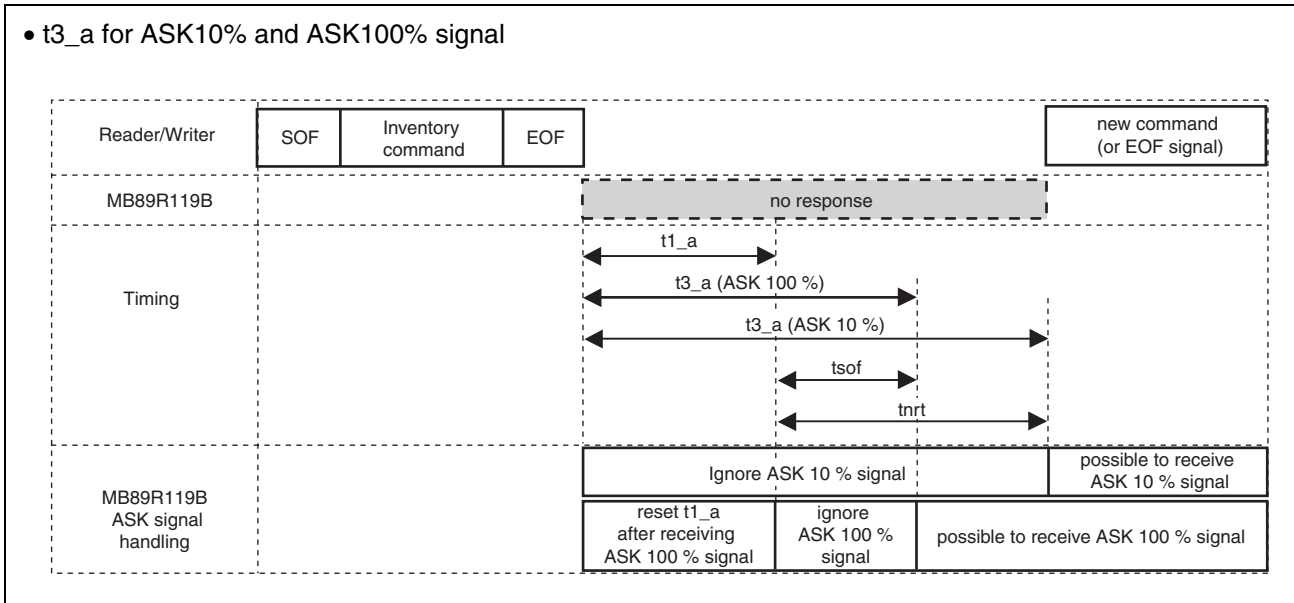

• Timing specification

	Min	Typ	Max
t1_a	$4320/fc = 318.6 \mu s$	$4352/fc = 320.9 \mu s$	$4384/fc = 323.3 \mu s$
tmit	$4384/fc(323.3 \mu s) + tnrt$	—	—
t2_a	$4192/fc = 309.2 \mu s$	—	—
t2invwr	$t2_a + tnrt$	—	—
t3_a (ASK10%)	$4384/fc(323.3 \mu s) + tnrt$	—	—
t3_a (ASK100%)	$4384/fc(323.3 \mu s) + tsof$	—	—
tnrt	—	Low data rate : 15708.16 μs High data rate : 3927.04 μs Fast Low data rate : 7854.08 μs Fast High data rate : 1963.52 μs	—
tsof	—	Low data rate : 604.16 μs High data rate : 151.04 μs Fast Low data rate : 302.08 μs Fast High data rate : 75.52 μs	—

■ COMMAND LIST

Mandatory and Optional commands defined by ISO/IEC 15693-3 are supported (Partly not supported*).

* : Refer to “■ NOTES ON USING”.

The following Custom commands are supported :

- EAS command : Using for preventing the theft of goods and monitoring
- Write EAS command : Writing data to the EAS bit
- Fast command : Responds faster than the ISO command
- Kill command : Disabling the function of tag

• Command list

Command code	Command name	Command Type	Details
“01 _H ”	Inventory	Mandatory	Execute the anti-collision sequence and get UID.
“02 _H ”	Stay Quiet	Mandatory	Enter the Quiet state
“20 _H ”	Read Single Block	Optional	Read the requested 1 block data in the user area/system area
“21 _H ”	Write Single Block	Optional	Write the requested 1 block data in the user area
“22 _H ”	Lock Block	Optional	Lock (disable to write) the requested 1 block in the user area
“23 _H ”	Read Multiple Blocks	Optional	Read the requested up to 64 blocks data in the user area/system area
“24 _H ”	Write Multiple Blocks	Optional	Write the requested 1 block or 2 blocks data in the user area
“25 _H ”	Select	Optional	Enter the select (communication selected) state
“26 _H ”	Reset to Ready	Optional	Enter the ready (communication enabled) state
“27 _H ”	Write AFI	Optional	Write AFI (Application Family Identifier) data into FRAM.
“28 _H ”	Lock AFI	Optional	Lock (disable to write) AFI data
“29 _H ”	Write DSFID	Optional	Write DSFID (Data Storage Format Identifier) data into FRAM
“2A _H ”	Lock DSFID	Optional	Lock (disable to write) DSFID (Data Storage Format Identifier)
“2B _H ”	Get System Information	Optional	Read the system information (UID, DSFID, AFI, number of bytes per block, number of blocks in user area, and IC information)
“2C _H ”	Get Multiple Block Security Status	Optional	Read the block security status stored in system area.
“A0 _H ”	EAS	Custom	When EAS bit is “1”, reply response code 6 times.
“A1 _H ”	Write EAS	Custom	Write EAS data (1 bit). Data “1” validates anti-theft/article surveillance, and data “0” invalidates them.
“A6 _H ”	Kill	Custom	Disable the function of tag
“B1 _H ”	Fast Inventory	Custom	Fast response Inventory command
“C3 _H ”	Fast Read Multiple Blocks	Custom	Fast response Read Multiple Blocks command
“C4 _H ”	Fast Write Multiple Blocks	Custom	Fast response Write Multiple Blocks command

■ COMMAND DESCRIPTION

1. Description of Mandatory Command

1-1. Inventory command

The Inventory command executes the anti-collision sequence.

Even though an error is detected during execution of this command, a response indicating the error is not returned.

The Inventory_flag (bit3) must be set to "1".

When the AFI_flag (bit5) in the Inventory command frame is set as "1", the response is returned in the following cases.

- The AFI value of the transponder is in accord with the Optional AFI value.
- The 4 bits value MSB of the Optional AFI is "0H", and the 4 bits value LSB of the Optional AFI is in accord with the 4 bits value LSB of the transponder.
- The 4 bits value LSB of the Optional AFI is "0H", and the 4 bits value MSB of the Optional AFI is in accord with the 4 bits value MSB of the transponder.
- The Optional AFI value is "00H".

For example, if the AFI value of the transponder is "69H", the response is returned when the Optional AFI value is "69H", "60H", "09H" or "00H".

- Request (from the reader/writer to the transponder)

SOF	Flags	Command (Inventory)	Optional AFI	Mask length	Mask value	CRC	EOF
	8 bits	8 bits ("01H")	8 bits	8 bits	0 to 64 bits	16 bits	

- Response (from the transponder to the reader/writer)

SOF	Flags	DSFID	UID	CRC	EOF
	8 bits ("00H")	8 bits	64 bits	16 bits	

1-2. Stay Quiet command

On receiving the Stay Quiet command, the transponder enters the quiet state. The transponder does not return any responses, including an error indication.

In the quiet state, the transponder does not execute any request for which the Inventory_flag (bit 3) is set to "1" and executes only a command for which the Address_flag (bit 6) is set to "1".

The transponder exits the quiet state only in the following cases :

- The transponder enters the power-off state.
- The transponder receives the Reset to Ready command and enters the ready state.

- Request (from the reader/writer to the transponder)

SOF	Flags	Command (Stay Quiet)	UID (necessary)	CRC	EOF
	8 bits	8 bits ("02H")	64 bits	16 bits	

- Response (from the transponder to the reader/writer)

No response

2. Description of Optional Command

2-1. Read Single Block command

On receiving the Read Single Block command, the transponder reads the data stored in the specified single-block to the reader/writer.

If the Option_flag (bit 7) is "1", the transponder adds block security status information in the response. If the Option_flag (bit 7) is "0", the transponder returns only the data in the specified block to the reader/writer.

- Request

[Request from the reader/writer to the transponder]

SOF	Flag	Command (Read Single Block)	UID (Addressed mode)	Block number	CRC	EOF
	8 bits	8 bits ("20H")	64 bits	8 bits	16 bits	

- Response

[Response from the transponder to the reader/writer]

(1) When Error_flag set

SOF	Flag	Error code	CRC	EOF
	8 bits ("01H")	8 bits	16 bits	

(2) When Error_flag not set

SOF	Flag	Block security status (option)	Data	CRC	EOF
	8 bits ("00H")	8 bits	32 bits	16 bits	

2-2. Write Single Block command

On receiving the Write Single Block command, the transponder writes the requested block with the data contained in the request and reports success of the operation in the response.

The transponder performs verification after writing and returns an error code if the writing has failed.

If the Option_flag (bit 7) is "0", the transponder shall return its response when it has completed the write operation starting after $\langle t_{1nom} + \text{a multiple of } 4096/f_c (302.1 \mu\text{s}) \rangle$ with total tolerance of $\pm 32/f_c (2.4 \mu\text{s})$ and latest within 20 ms. If it is "1", transponder shall wait for the reception of an EOF from the reader/writer and upon such reception still return its response. (However, if an EOF is not sent within 20 ms, the time-out occurs and the transponder can receive another command.) $\langle t_{1nom} = 320.9 \mu\text{s} (\text{typical}) \rangle$

- Request (from the reader/writer to the transponder)

SOF	Flags	Command (Write Single Block)	UID (Addressed mode)	Block number	Data	CRC	EOF
	8 bits	8 bits ("21H")	64 bits	8 bits	32 bits	16 bits	

- Response (from the transponder to the reader/writer)

(1) When Error_flag set

SOF	Flags	Error code	CRC	EOF
	8 bits ("01H")	8 bits	16 bits	

(2) When Error_flag not set

SOF	Flags	CRC	EOF
	8 bits ("00H")	16 bits	

2-3. Lock Block command

On receiving the Lock Block command, the transponder locks (write disable) permanently the requested block.

The transponder performs verification after writing and returns an error code if the writing has failed.

If the Option_flag (bit 7) is "0", the transponder shall return its response when it has completed the lock operation starting after $\langle t1_{nom} + \text{a multiple of } 4096/f_c (302.1 \mu\text{s}) \rangle$ with total tolerance of $\pm 32/f_c (2.4 \mu\text{s})$ and latest within 20 ms. If it is "1", transponder shall wait for the reception of an EOF from the reader/writer and upon such reception still return its response. (However, if an EOF is not sent within 20 ms, the time-out occurs and the transponder can receive another command.)

Once the Lock Block command has been received, data in the locked block cannot be changed by the Write commands.

- Request (from the reader/writer to the transponder)

SOF	Flags	Command (Lock Block)	UID (Addressed mode)	Block number	CRC	EOF
	8 bits	8 bits ("22H")	64 bits	8 bits	16 bits	

- Response (from the transponder to the reader/writer)

(1) When Error_flag set

SOF	Flags	Error code	CRC	EOF
	8 bits ("01H")	8 bits	16 bits	

(2) When Error_flag not set

SOF	Flags	CRC	EOF
	8 bits ("00H")	16 bits	

2-4. Read Multiple Blocks Command

On receiving the Read Multiple Blocks command, the transponder reads the requested block(s) and returns their value in the response.

Up to 64 blocks of data can be read for one request.

If the Option_flag (bit 7) is "1", the transponder adds block security status information in the response. If the Option_flag (bit 7) is "0", the transponder returns only the data in the specified blocks to the reader/writer.

The value of the "number of blocks" field specified in the request is the expected number of blocks minus 1. Setting the number of blocks to "06H" makes a request to read 7 blocks. Setting the number of blocks to "00H" makes a request to read 1 block (the request having the same effect as the Read Single Block command).

The maximum number of blocks to be set is "3FH".

- Request (from the reader/writer to the transponder)

SOF	Flags	Command (Read Multiple Blocks)	UID (Addressed mode)	First block number	Number of blocks	CRC	EOF
	8 bits	8 bits ("23H")	64 bits	8 bits	8 bits	16 bits	

- Response (from the transponder to the reader/writer)

(1) When Error_flag set

SOF	Flags	Error code	CRC	EOF
	8 bits ("01 _H ")	8 bits	16 bits	

(2) When Error_flag not set

SOF	Flag	Block security status (option)	Data	CRC	EOF
	8 bits ("00 _H ")	8 bits	64 bits	16 bits	
Repeated as required					

2-5. Write Multiple Blocks Command

On receiving the Write Multiple Blocks command, the transponder writes the requested block(s) with the data contained in the request and reports the success of the operation in the response.

Up to 2 blocks of data can be written for one request.

The transponder performs verification after writing and returns an error code if the writing has failed. The number of blocks specified in the Write Multiple Blocks command is similar to the number of blocks specified in the Read Multiple Blocks command. The value of the number of blocks field specified in the Write Multiple Blocks command is obtained by subtracting 1 from the number of the expected blocks to be written.

Setting the number of blocks to "01_H" makes a request to write 2 blocks. Setting the number of blocks to "00_H" makes a request to write 1 block (the request having the same effect as the Write Single Block command).

If at least one of the blocks specified by the command is locked, the transponder does not write any data and, instead, returns an error code.

If the Option_flag (bit 7) is "0", the transponder shall return its response when it has completed the write operation starting after $\langle t1_{nom} + \text{a multiple of } 4096/f_c (302.1 \mu s) \rangle$ with total tolerance of $\pm 32/f_c (2.4 \mu s)$ and latest within 20 ms. If it is "1", transponder shall wait for the reception of an EOF from the reader/writer and upon such reception still return its response. (However, if an EOF is not sent within 20 ms, the time-out occurs and the transponder can receive another command.)

- Request (from the reader/writer to the transponder)

SOF	Flags	Command (Write Multiple Blocks)	UID (Addressed mode)	First block number	Block number	Data	CRC	EOF
	8 bits	8 bits ("24 _H ")	64 bits	8 bits	8 bits	32 or 64 bits	16 bits	

- Response (from the transponder to the reader/writer)

(1) When Error_flag set

SOF	Flags	Error code	CRC	EOF
	8 bits ("01 _H ")	8 bits	16 bits	

(2) When Error_flag not set

SOF	Flags	CRC	EOF
	8 bits ("00 _H ")	16 bits	

2-6. Select command

Of the transponders that received the Select command, only the transponder whose UID matches the UID included in the request enters the select state and returns a response.

The other transponders, whose UIDs do not match the UID in the request, enter the ready states without returning any response. The Select command is used only in Addressed mode.

- Request

[From the reader/writer to the transponder]

SOF	Flag	Command (Select)	UID (necessary)	CRC	EOF
	8 bits	8 bits ("25H")	64 bits	16 bits	

- Response

[From the transponder to the reader/writer]

(1) When Error_flag set

SOF	Flag	Error code	CRC	EOF
	8 bits ("01H")	8 bits	16 bits	

(2) When Error_flag not set

SOF	Flag	CRC	EOF
	8 bits ("00H")	16 bits	

2-7. Reset to Ready command

On receiving the Reset to Ready command, the transponder returns to the ready state.

- Request (from the reader/writer to the transponder)

SOF	Flags	Command (Reset to Ready)	UID (Addressed mode)	CRC	EOF
	8 bits	8 bits ("26H")	64 bits	16 bits	

- Response (from the transponder to the reader/writer)

(1) When Error_flag set

SOF	Flags	Error code	CRC	EOF
	8 bits ("01H")	8 bits	16 bits	

(2) When Error_flag not set

SOF	Flags	CRC	EOF
	8 bits ("00H")	16 bits	

2-8. Write AFI command

On receiving the Write AFI command, the transponder writes AFI value into FRAM.

The transponder performs verification after writing and returns an error code if the writing has failed.

If the Option_flag (bit 7) is "0", the transponder shall return its response when it has completed the write operation starting after $\langle t_{1nom} + \text{a multiple of } 4096/f_c (302.1 \mu\text{s}) \rangle$ with total tolerance of $\pm 32/f_c (2.4 \mu\text{s})$ and latest within 20 ms. If it is "1", transponder shall wait for the reception of an EOF from the reader/writer and upon such reception still return its response. (However, if an EOF is not sent within 20 ms, the time-out occurs and the transponder can receive another command.)

- Request (from the reader/writer to the transponder)

SOF	Flags	Command (Write AFI)	UID (Addressed mode)	AFI	CRC	EOF
	8 bits	8 bits ("27H")	64 bits	8 bits	16 bits	

- Response (from the transponder to the reader/writer)

(1) When Error_flag set

SOF	Flags	Error code	CRC	EOF
	8 bits ("01H")	8 bits	16 bits	

(2) When Error_flag not set

SOF	Flags	CRC	EOF
	8 bits ("00H")	16 bits	

2-9. Lock AFI command

On receiving the Lock AFI command, the transponder locks (write disable) the AFI value permanently into FRAM.

The transponder performs verification after writing and returns an error code if the writing has failed.

If the Option_flag (bit 7) is "0", the transponder shall return its response when it has completed the lock operation starting after $\langle t_{1nom} + \text{a multiple of } 4096/f_c (302.1 \mu\text{s}) \rangle$ with total tolerance of $-32/f_c$ to $+32/f_c (2.4 \mu\text{s})$ and latest within 20 ms. If it is "1", transponder shall wait for the reception of an EOF from the reader/writer and upon such reception still return its response. (However, if an EOF is not sent within 20 ms, the time-out occurs and the transponder can receive another command.)

Once the Lock AFI command has been received, the AFI data cannot be changed by the Write AFI command.

- Request (from the reader/writer to the transponder)

SOF	Flags	Command (Lock AFI)	UID (Addressed mode)	CRC	EOF
	8 bits	8 bits ("28H")	64 bits	16 bits	

- Response (from the transponder to the reader/writer)

(1) When Error_flag set

SOF	Flags	Error code	CRC	EOF
	8 bits ("01H")	8 bits	16 bits	

(2) When Error_flag not set

SOF	Flags	CRC	EOF
	8 bits ("00H")	16 bits	

2-10. Write DSFID command

On receiving the Write DSFID command, the transponder writes the DSFID value into FRAM.

The transponder performs verification after writing and returns an error code if the writing has failed.

If the Option_flag (bit 7) is "0", the transponder shall return its response when it has completed the write operation starting after $\langle t_{1nom} + \text{a multiple of } 4096/f_c (302.1 \mu\text{s}) \rangle$ with total tolerance of $\pm 32/f_c (2.4 \mu\text{s})$ and latest within 20 ms. If it is "1", transponder shall wait for the reception of an EOF from the reader/writer and upon such reception still return its response. (However, if an EOF is not sent within 20 ms, the time-out occurs and the transponder can receive another command.)

- Request (from the reader/writer to the transponder)

SOF	Flags	Command (Write DSFID)	UID (Addressed mode)	DSFID	CRC	EOF
	8 bits	8 bits ("29H")	64 bits	8 bits	16 bits	

- Response (from the transponder to the reader/writer)

(1) When Error_flag set

SOF	Flags	Error code	CRC	EOF
	8 bits ("01H")	8 bits	16 bits	

(2) When Error_flag not set

SOF	Flags	CRC	EOF
	8 bits ("00H")	16 bits	

2-11. Lock DSFID command

On receiving the Lock DSFID command, the transponder locks (write disable) the DSFID value permanently into FRAM.

The transponder performs verification after writing and returns an error code if the writing has failed.

If the Option_flag (bit 7) is "0", the transponder shall return its response when it has completed the lock operation starting after $\langle t_{1nom} + \text{a multiple of } 4096/f_c (302.1 \mu\text{s}) \rangle$ with total tolerance of $\pm 32/f_c (2.4 \mu\text{s})$ and latest within 20 ms. If it is "1", transponder shall wait for the reception of an EOF from the reader/writer and upon such reception still return its response. (However, if an EOF is not sent within 20 ms, the time-out occurs and the transponder can receive another command.)

Once the Lock DSFID command has been received, the DSFID data cannot be changed by the Write DSFID command.

- Request (from the reader/writer to the transponder)

SOF	Flags	Command (Lock DSFID)	UID (Addressed mode)	CRC	EOF
	8 bits	8 bits ("2AH")	64 bits	16 bits	

- Response (from the transponder to the reader/writer)

(1) When Error_flag set

SOF	Flags	Error code	CRC	EOF
	8 bits ("01H")	8 bits	16 bits	

(2) When Error_flag not set

SOF	Flags	CRC	EOF
	8 bits ("00H")	16 bits	

MB89R119B

2-12. Get System Information command

On receiving the Get System Information command, the transponder returns the system information of UID, AFI, DSFID, etc.

- Request (from the reader/writer to the transponder)

SOF	Flags	Command (Get System Information)	UID (Addressed mode)	CRC	EOF
	8 bits	8 bits ("2B _H ")	64 bits	16 bits	

- Response (from the transponder to the reader/writer)

(1) When Error_flag set

SOF	Flags	Error code	CRC	EOF
	8 bits ("01 _H ")	8 bits	16 bits	

(2) When Error_flag not set

SOF	Flags	Information flags	UID	DSFID	AFI	Memory size	IC reference	CRC	EOF
	8 bits ("00 _H ")	8 bits	64 bits	8 bits	8 bits	16 bits	8 bits	16 bits	

The following table shows the definitions of the Information flag. The following figure shows the memory size information included in the response of the Get System Information. However, the block size and number of blocks in the user area shown in the memory size information about the transponder indicates one less than the actual value.

- Definition of information flag

Bit	Flag name	State	Description
1	DSFID	0	DSFID is not supported or does not exist.
		1	DSFID is supported or exists.
2	AFI	0	AFI is not supported or does not exist.
		1	AFI is supported or exists.
3	Memory size	0	Memory size information is not supported or does not exist.
		1	Memory size information is supported or exists.
4	IC reference	0	IC reference information is not supported or does not exist.
		1	IC reference information is supported or exists.
5	RFU*	—	Set to "0"
6	RFU*	—	
7	RFU*	—	
8	RFU*	—	

* : Reserved for future use

Note : For MB89R119B set "0F_H" ("1" for bit1 to bit4 and set "0" for bit5 to bit8) .

- Memory size information about a transponder

MSB				LSB			
16	14	13	9	8	1		
RFU*		Blocks size in bytes			Number of blocks in user area		

* : Reserved for future use

Note : The memory size of the MB89R119B which is consisted of 58 blocks (4 bytes per block) in the user area is hexadecimal "0339_H".

2-13. Get Multiple Block Security Status Command

On receiving the Get Multiple Block Security Status command, the transponder reads the block security status stored in a system area to the reader/writer as a response.

Up to 58 blocks of data can be read for one request. The number of blocks specified in this request must be the value that is 1 block less than the actual number of the blocks whose security status is to be obtained.

The first block number specified in this request must be a multiple of 8.

- Request

[Request from the reader/writer to the transponder]

SOF	Flag	Command (Get Multiple Block Security Status)	UID (Addressed mode)	First block number	Number of blocks	CRC	EOF
	8 bits	8 bits ("2C _H ")	64 bits	8 bits	8 bits	16 bits	

- Response

[Response from the transponder to the reader/writer]

(1) When Error_flag set

SOF	Flag	Error code	CRC	EOF
	8 bits ("01 _H ")	8 bits	16 bits	

(2) When Error_flag not set

SOF	Flag	Block security status	CRC	EOF
	8 bits ("00 _H ")	8 bits (repeated as required)	16 bits	

3. Custom Command

The IC manufacturing code is required to use a Custom command. The IC manufacturing code for the MB89R119B is "08_H".

3-1. EAS command

On EAS command reception, the transponder returns the response code ("5A_H") repeated 6 times after the specified flag ("00_H") if the EAS bit is "1" or returns no response if the EAS bit is "0". The EAS command can be executed only when the transponder is in the Ready state.

- Request (from the reader/writer to the transponder)

SOF	Flags	Command (EAS)	IC manufacturing code (necessary)	CRC	EOF
	8 bits	8 bits ("A0 _H ")	8 bits("08 _H ")	16 bits	

- Response (from the transponder to the reader/writer)

SOF	Flags	Response code	CRC	EOF
	8 bits ("00 _H ")	48 bits (6 times repeat of "5A _H ")	16 bits	

3-2. Write EAS command

On Write EAS command reception, the transponder writes the EAS bit into FRAM.

The transponder performs verification after writing and returns an error code if the writing has failed.

The EAS bit must be set to "00_H" to cancel anti-theft or goods-monitoring mode. The bit must be set to "01_H" as the EAS data to set up the goods-monitoring mode.

If the Option_flag (bit 7) is "0", the transponder shall return its response when it has completed the write operation starting after $\langle t_{1nom} + \text{a multiple of } 4096/f_c (302.1 \mu\text{s}) \rangle$ with total tolerance of $-32/f_c$ to $+32/f_c$ (2.4 μs) and latest within 20 ms. If it is "1", transponder shall wait for the reception of an EOF from the reader/writer and upon such reception still return its response. (However, if an EOF is not sent within 20 ms, the time-out error occurs and the transponder can receive another command.)

- Request (from the reader/writer to the transponder)

SOF	Flags	Command (Write EAS)	IC manufacturing code (necessary)	UID (Addressed mode)	Data	CRC	EOF
	8 bits	8 bits ("A1 _H ")	8 bits ("08 _H ")	64 bits	8 bits ("00 _H " or "01 _H ")	16 bits	

- Response (from the transponder to the reader/writer)

(1) When Error_flag set

SOF	Flags	Error code	CRC	EOF
	8 bits ("01 _H ")	8 bits	16 bits	

(2) When Error_flag not set

SOF	Flags	CRC	EOF
	8 bits ("00 _H ")	16 bits	

3-3. Kill Command

On the receiving the Kill command, the transponder is disabled permanently and enters the Dead state. Even if the transponder is moved in the magnetic field (power-on state) again after being removed out of the magnetic field (power-off state), the transponder stays in the Dead state and never respond to any commands from the reader/writer.

- Request (from the reader/writer to the transponder)

SOF	Flags	Command(Kill)	IC Mfg code (necessary)	UID (necessary)	CRC	EOF
	8 bits	8 bits ("A6H")	8 bits ("08H")	64 bits	16 bits	

- Response (from the transponder to the reader/writer)

SOF	Flags	CRC	EOF
	8 bits ("00H")	16 bits	

WARNING: The transponder received Kill command is disabled and cannot be used again.

3-4. Fast Inventory Command

The Fast Inventory command is the same as the Inventory Command that executes the anti-collision sequence. The data rate in the response is twice as defined in ISO/IEC 15693. Even though an error is detected during execution of this command, a response indicating the error is not returned.

The Inventory_flag (bit3) must be set to "1".

When the AFI_flag (bit5) in the Inventory command frame is set as "1", the response is returned in the following cases.

- The AFI value of the transponder is in accord with the Optional AFI value.
- The 4 bits value MSB of the Optional AFI is "0H", and the 4 bits value LSB of the Optional AFI is in accord with the 4 bits value LSB of the transponder.
- The 4 bits value LSB of the Optional AFI is "0H", and the 4 bits value MSB of the Optional AFI is in accord with the 4 bits value MSB of the transponder.
- The Optional AFI value is "00H".

For example, if the AFI value of the transponder is "69H", the response is returned when the Optional AFI value is "69H", "60H", "09H" or "00H".

- Request (from the reader/writer to the transponder)

SOF	Flags	Command (Fast Inventory)	IC manufacturing code (necessary)	Optional AFI	Mask length	Mask value	CRC	EOF
	8 bits	8 bits ("B1H")	8 bits ("08H")	8 bits	8 bits	0 to 64 bits	16 bits	

- Response (from the transponder to the reader/writer)

SOF	Flags	DSFID	UID	CRC	EOF
	8 bits ("00H")	8 bits	64 bits	16 bits	

3-5. Fast Read Multiple Blocks Command

The Fast Read Multiple Blocks command is the same as the Read Multiple Blocks Command that reads the requested block(s). Up to 64 blocks of data can be read for one request. The data rate in the response is twice as defined in ISO/IEC 15693.

If the Option_flag (bit 7) is “1”, the transponder adds block security status information in the response. If the Option_flag (bit 7) is “0”, the transponder returns only the data in the specified blocks to the reader/writer.

The value of the “number of blocks” field specified in the request is the expected number of blocks minus 1. Setting the number of blocks to “06_H” makes a request to read 7 blocks. The maximum number of blocks to be set is “3F_H”.

- Request (from the reader/writer to the transponder)

SOF	Flags	Command (Fast Read Multiple Blocks)	IC manufacturing code (necessary)	UID (Addressed mode)	First block number	Number of blocks	CRC	EOF
	8 bits	8 bits (“C3 _H ”)	8 bits (“08 _H ”)	64 bits	8 bits	8 bits	16 bits	

- Response (from the transponder to the reader/writer)

(1) When Error_flag set

SOF	Flags	Error code	CRC	EOF
	8 bits (“01 _H ”)	8 bits	16 bits	

(2) When Error_flag not set

SOF	Flag	Block security status(option)	Data	CRC	EOF
	8 bits (“00 _H ”)	8 bits	64 bits	16 bits	
Repeated as required					

3-6. Fast Write Multiple Blocks Command

The Fast Write Multiple Blocks command is the same as the Write Multiple Blocks Command, that writes the requested block(s). Up to 2 blocks of data can be written for one request. The data rate in the response is twice as defined in ISO/IEC 15693.

The transponder performs verification after writing and returns an error code if the writing has failed. The number of blocks specified in the Fast Write Multiple Blocks command is similar to the number of blocks specified in the Read Multiple Blocks command. The value of the number of blocks field specified in the Fast Write Multiple Blocks command is obtained by subtracting 1 from the number of the expected blocks to be written.

Setting the number of blocks to “01_H” makes a request to write 2 blocks. Setting the number of blocks to “00_H” makes a request to write 1 block.

If at least one of the blocks specified for data writing is locked, the transponder does not write any data and, instead, returns an error code.

If the Option_flag (bit 7) is “0”, the transponder shall return its response when it has completed the write operation starting after $\langle t_{1nom} + \text{a multiple of } 4096/f_c \text{ (302.1 } \mu\text{s)} \rangle$ with total tolerance of $- 32/f_c$ to $+ 32/f_c$ (2.4 μs) and latest within 20 ms. If it is “1”, transponder shall wait for the reception of an EOF from the reader/writer and upon such reception still returns its response (However, if an EOF is not sent within 20 ms, the time-out occurs and the transponder can receive another command) .

- Command (from the reader/writer to the transponder)

SOF	Flags	Command (Fast Write Multiple Blocks)	IC manufacturing code	UID (Addressed mode)	First block number	Number of blocks	Data	CRC	EOF
	8 bits	8 bits ("C4 _H ")	8 bits ("08 _H ")	64 bits	8 bits	8 bits	32 or 64 bits	16 bits	

- Response (from the transponder to the reader/writer)

(1) When Error_flag set

SOF	Flags	Error code	CRC	EOF
	8 bits ("01 _H ")	8 bits	16 bits	

(2) When Error_flag not set

SOF	Flags	CRC	EOF
	8 bits ("00 _H ")	16 bits	

4. Command Execution Time

4-1. Write Multiple Blocks Command Execution Time

The minimum time (processing in the Addressed mode) required to complete data writing to all user areas (232 bytes) of the FRAM and verification with the Write Multiple Blocks command is estimated to be 249 ms.

4-2. Read Multiple Blocks Command Execution Time

The minimum time (processing in the Addressed mode) required to complete data reading for all user areas (232 bytes) of the FRAM with the Read Multiple Blocks command is estimated to be 76 ms.
In addition, with the Fast Read Multiple Blocks command is estimated to be 41 ms.

■ STATE TRANSITION DIAGRAM

• Definition of states

Each state of MB89R119B is defined as follows.

- Power-off state : In the power-off state, a transponder cannot fulfill the function so that the voltage from a reader/writer is underpowered.
- Ready state : In the ready state, the MB89R119B can execute all commands if the Select_flag is not set.
- Quiet state : In the quiet state, the MB89R119B can execute the command for which the Inventory_flag is not set and the Address_flag is set.
- Select state : In the select state, the MB89R119B can execute the command for which the Select_flag is set.

As shown in figure below, the MB89R119B moves from one state to another according to the status of power and by a command.

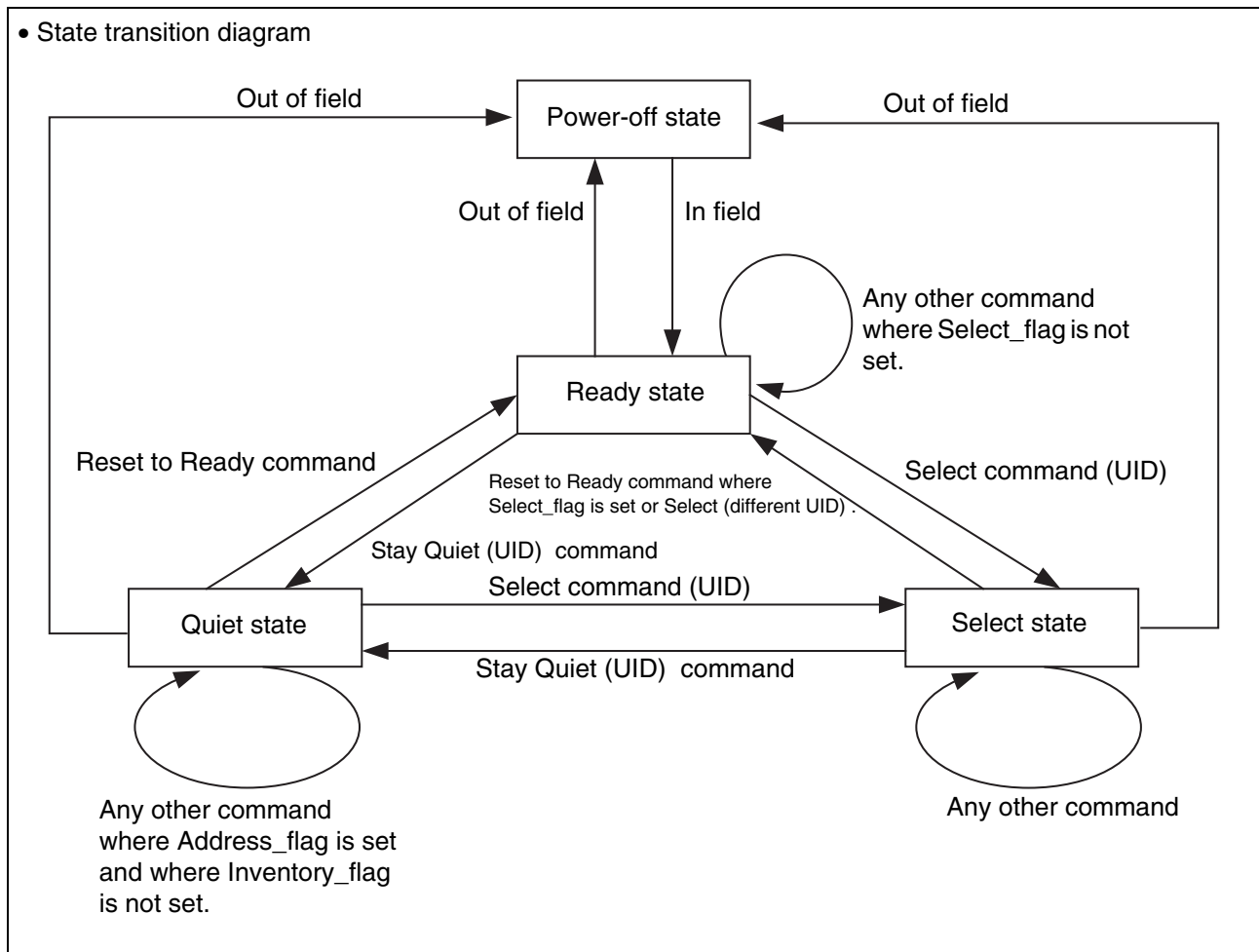

■ ABSOLUTE MAXIMUM RATINGS

Parameter	Symbol	Ratings		Unit	Remarks
		Min	Max		
Maximum antenna input current	I _{max}	—	90	mA _{p-p}	
Input current	I _{RF}	—	30	mA _{rms}	Antenna connected.
ESD voltage immunity	V _{ESD}	± 2	—	kV	Human body model
Storage temperature	T _{stg}	- 40	+ 125	°C	

WARNING: Semiconductor devices can be permanently damaged by application of stress (voltage, current, temperature, etc.) in excess of absolute maximum ratings. Do not exceed these ratings.

■ RECOMMENDED OPERATING CONDITIONS

Parameter	Symbol	Value			Unit	Remarks
		Min	Typ	Max		
Minimum antenna input voltage	V _{RF}	—	6.2	6.5	V _{p-p}	Antenna connected.
ASK modulation index (10%)	m	10	—	30	%	Antenna connected.
ASK modulation index (100%)	m	95	—	100	%	Antenna connected.
ASK pulse width (10%)	t ₁	6.0	—	9.44	μs	Antenna connected.
	t ₂	3.0	—	t ₁	μs	Antenna connected.
	t ₃	0	—	4.5	μs	Antenna connected.
ASK pulse width (100%)	t ₁	6.0	—	9.44	μs	Antenna connected.
	t ₂	2.1	—	t ₁	μs	Antenna connected.
	t ₃	1.0	—	4.5	μs	Antenna connected.
	t ₄	0	—	0.8	μs	Antenna connected.
Input frequency	F _{in}	13.553	13.560	13.567	MHz	Antenna connected.
Operating temperature	T _a	- 20	—	+ 85	°C	

WARNING: The recommended operating conditions are required in order to ensure the normal operation of the semiconductor device. All of the device's electrical characteristics are warranted when the device is operated within these ranges.

Always use semiconductor devices within their recommended operating condition ranges. Operation outside these ranges may adversely affect reliability and could result in device failure.

No warranty is made with respect to uses, operating conditions, or combinations not represented on the data sheet. Users considering application outside the listed conditions are advised to contact their representatives beforehand.

However, because the communication characteristics is deeply related with the combination of antenna, reader/writer, and operating environment, this condition dose not ensure the complete operation of transponders. Therefore it is recommended to confirm the communication characteristics with the actual antenna and reader/writer beforehand.

The values are confirmed with a reference antenna, and its parameters are as following.

External size : 75 mm × 46 mm
 Number of turns : 6
 Width of conductor : 1 mm
 Space between 2 conductors : 0.4 mm

■ ELECTRICAL CHARACTERISTICS

DC characteristics

Parameter	Symbol	Value			Unit	Remarks	
		Min	Typ	Max			
Load modulation resistance	R _{isw}	—	1.1	—	kΩ		
Input capacitance*	24pF	C _{ant}	22.8	24.0	25.2	pF	Voltage between antennas = 2 V _{rms}
	96pF		86.4	96.0	105.6		

* : The capacitance value is an alternative value, which is distinguished with the part number. The values are controlled by PCM (Process Control Monitor) in the wafer.

■ NOTES ON USING

• Notes on the radio interface

- The performance of transponder is determined by not only LSI specification but also antenna design and reader/writer characteristics. Therefore it is recommended for the customers to optimize the antenna and reader/writer according to the required communication distance and usage environment.
- If the user intends to access multiple transponders from a reader/writer, the interference between transponders or between the reader/writer and a transponder may degrade communication performance (transmission distance and communication time). Therefore, a user who intends to design a system using multiple transponders should consider this point.

• FRAM reliability

Up to 10^{10} writes and reads to the FRAM memory and 10 years of data retention at $T_a = + 70 \text{ }^\circ\text{C}$ are guaranteed. For the data retention characteristics of the mounting temperature at $+ 150 \text{ }^\circ\text{C}$ or higher, refer to “■ SHIPPING METHOD AND RECOMMENDED ASSEMBLY CONDITIONS”.

• Differences of the function between ISO/IEC15693 and MB89R119B.

The comparison of the function between ISO/IEC 15693 and MB89R119B is shown in the table below.

MB89R119B does not support the following functions.

- 1 out of 256 data coding
- 2-subcarrier

The Read Multiple Blocks command supports up to 64 blocks. The Write Multiple Blocks command supports up to 2 blocks.

• MB89R119B functions compared with ISO/IEC15693

Parameter	ISO/IEC15693 specification	MB89R119B
Modulation	10% ASK	Correspondence
	100% ASK	Correspondence
Data coding	1 out of 256	Not correspondence
	1 out of 4	Correspondence
Subcarrier	1-subcarrier	Correspondence
	2-subcarrier	Not correspondence
Mandatory command	Inventory command	Correspondence
	Stay Quiet command	Correspondence
Optional command	Read Single Block command	Correspondence
	Write Single Block command	Correspondence
	Lock Block command	Correspondence
	Read Multiple Blocks command	Correspondence up to 64 blocks
	Write Multiple Blocks command	Correspondence up to 2 blocks
	Select command	Correspondence
	Reset to Ready command	Correspondence
	Write AFI command	Correspondence
	Lock AFI command	Correspondence
	Write DSFID command	Correspondence
	Lock DSFID command	Correspondence
	Get System Information command	Correspondence
	Get Multiple Block Security Status command	Correspondence

■ SHIPPING METHOD AND RECOMMENDED ASSEMBLY CONDITIONS

- Shipping method

The following shows shipping method and ordering information for the MB89R119B. Please inquire separately for the details.

Part no.	Input capacitance	Wafer thickness	Chip dicing	Bump	Shipping form
MB89R119B1-DIAP15	24 pF	150 $\mu\text{m} \pm 25.4 \mu\text{m}$	Completed	Au Plating	Wafer (with Frame)
MB89R119B2-DIAP15	96 pF				

- Recommended assembly conditions

The MB89R119B is recommended to be mounted in the following condition to maintain the data retention characteristics of the FRAM memory when the chip is mounted.

- Mounting temperature of + 175 °C or lower, and 120 minutes or shorter when applied at high temperature, or
- Mounting temperature of + 200 °C or lower, and 60 seconds or shorter when applied at high temperature

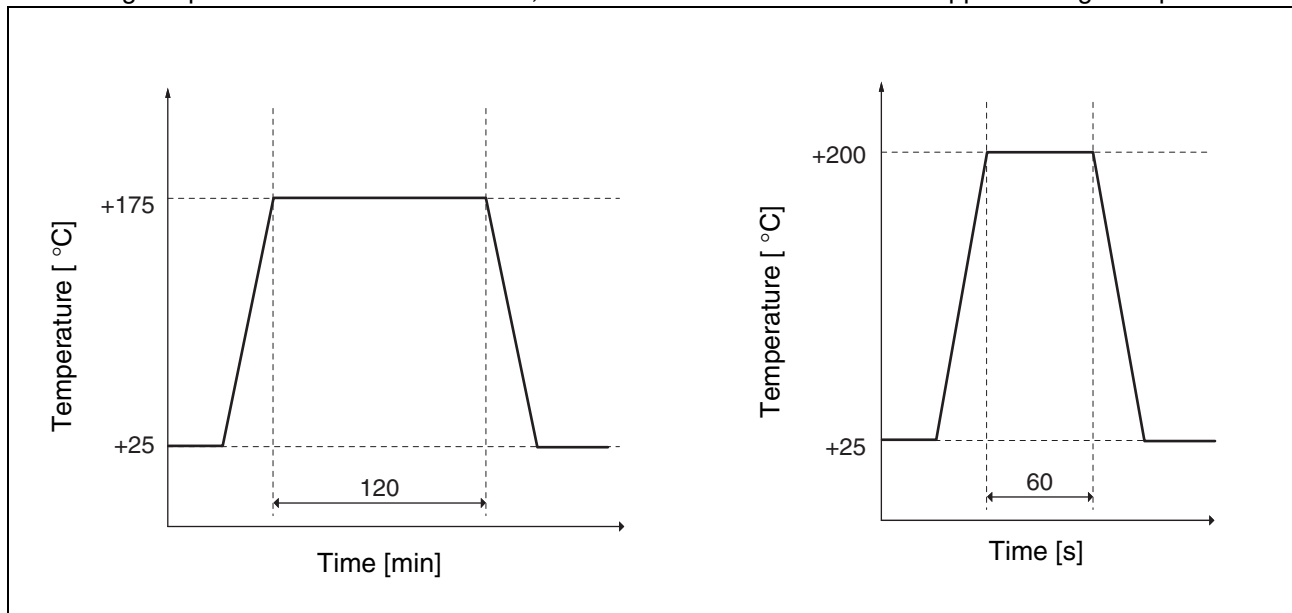

FUJITSU SEMICONDUCTOR LIMITED

Nomura Fudosan Shin-yokohama Bldg. 10-23, Shin-yokohama 2-Chome,
Kohoku-ku Yokohama Kanagawa 222-0033, Japan

Tel: +81-45-415-5858

<http://jp.fujitsu.com/fsl/en/>

For further information please contact:

North and South America

FUJITSU SEMICONDUCTOR AMERICA, INC.

1250 E. Arques Avenue, M/S 333

Sunnyvale, CA 94085-5401, U.S.A.

Tel: +1-408-737-5600 Fax: +1-408-737-5999

<http://us.fujitsu.com/micro/>

Asia Pacific

FUJITSU SEMICONDUCTOR ASIA PTE. LTD.

151 Lorong Chuan,

#05-08 New Tech Park 556741 Singapore

Tel : +65-6281-0770 Fax : +65-6281-0220

<http://sg.fujitsu.com/semiconductor/>

Europe

FUJITSU SEMICONDUCTOR EUROPE GmbH

Pittlerstrasse 47, 63225 Langen, Germany

Tel: +49-6103-690-0 Fax: +49-6103-690-122

<http://emea.fujitsu.com/semiconductor/>

FUJITSU SEMICONDUCTOR SHANGHAI CO., LTD.

30F, Kerry Parkside, 1155 Fang Dian Road, Pudong District,

Shanghai 201204, China

Tel : +86-21-6146-3688 Fax : +86-21-6146-3660

<http://cn.fujitsu.com/fss/>

Korea

FUJITSU SEMICONDUCTOR KOREA LTD.

902 Kosmo Tower Building, 1002 Daechi-Dong,

Gangnam-Gu, Seoul 135-280, Republic of Korea

Tel: +82-2-3484-7100 Fax: +82-2-3484-7111

<http://kr.fujitsu.com/fsk/>

FUJITSU SEMICONDUCTOR PACIFIC ASIA LTD.

10/F., World Commerce Centre, 11 Canton Road,

Tsimshatsui, Kowloon, Hong Kong

Tel : +852-2377-0226 Fax : +852-2376-3269

<http://cn.fujitsu.com/fsp/>

Specifications are subject to change without notice. For further information please contact each office.

All Rights Reserved.

The contents of this document are subject to change without notice.

Customers are advised to consult with sales representatives before ordering.

The information, such as descriptions of function and application circuit examples, in this document are presented solely for the purpose of reference to show examples of operations and uses of FUJITSU SEMICONDUCTOR device; FUJITSU SEMICONDUCTOR does not warrant proper operation of the device with respect to use based on such information. When you develop equipment incorporating the device based on such information, you must assume any responsibility arising out of such use of the information.

FUJITSU SEMICONDUCTOR assumes no liability for any damages whatsoever arising out of the use of the information.

Any information in this document, including descriptions of function and schematic diagrams, shall not be construed as license of the use or exercise of any intellectual property right, such as patent right or copyright, or any other right of FUJITSU SEMICONDUCTOR or any third party or does FUJITSU SEMICONDUCTOR warrant non-infringement of any third-party's intellectual property right or other right by using such information. FUJITSU SEMICONDUCTOR assumes no liability for any infringement of the intellectual property rights or other rights of third parties which would result from the use of information contained herein.

The products described in this document are designed, developed and manufactured as contemplated for general use, including without limitation, ordinary industrial use, general office use, personal use, and household use, but are not designed, developed and manufactured as contemplated (1) for use accompanying fatal risks or dangers that, unless extremely high safety is secured, could have a serious effect to the public, and could lead directly to death, personal injury, severe physical damage or other loss (i.e., nuclear reaction control in nuclear facility, aircraft flight control, air traffic control, mass transport control, medical life support system, missile launch control in weapon system), or (2) for use requiring extremely high reliability (i.e., submersible repeater and artificial satellite).

Please note that FUJITSU SEMICONDUCTOR will not be liable against you and/or any third party for any claims or damages arising in connection with above-mentioned uses of the products.

Any semiconductor devices have an inherent chance of failure. You must protect against injury, damage or loss from such failures by incorporating safety design measures into your facility and equipment such as redundancy, fire protection, and prevention of over-current levels and other abnormal operating conditions.

Exportation/release of any products described in this document may require necessary procedures in accordance with the regulations of the Foreign Exchange and Foreign Trade Control Law of Japan and/or US export control laws.

The company names and brand names herein are the trademarks or registered trademarks of their respective owners.

Edited: Sales Promotion Department