

# TRAILING EDGE PRODUCT - MINIMUM ORDER APPLIES



## 128K x 32 SRAM MODULE

### PUMA 68S4000X - 12/15/20/25

Elm Road, West Chirton Industrial Estate, North Shields,  
NE29 8SE, ENGLAND. TEL +44 (0191) 2930500. FAX +44 (0191)  
2590997

Issue 1.5 : December 1998

#### Description

The PUMA68S4000X is a 4Mbit CMOS High Speed Static RAM organised as 128K x 32 in a JEDEC 68 pin surface mount PLCC, available with access times of 15ns, 20ns, or 25ns. The output width is user configurable as 8, 16 or 32 bits using four Chip Selects (CS1-4).

The device features low power standby, multiple ground pins for maximum noise immunity and TTL compatible inputs and outputs. The PUMA 68S4000X offers a dramatic space saving advantage over four standard 128Kx8 devices. A low power standby option with 2V data retention mode is available.

#### Features

- Very Fast Access Times of 12/15/20/25 ns.
- JEDEC 68 'J' leaded plastic surface mount Substrate
- Upgradeable footprint.
- User Configurable as 8 / 16 / 32 bit wide output.
- Operating Power (32-BIT) 4.40 W (Max)  
Low Power Standby (TTL) 1.32 W (Max)  
-L Version (CMOS) 44 mW (Max)
- Fully Static operation.
- Multiple ground pins for maximum noise immunity.
- Single 5V±10% Power supply.

#### Block Diagram

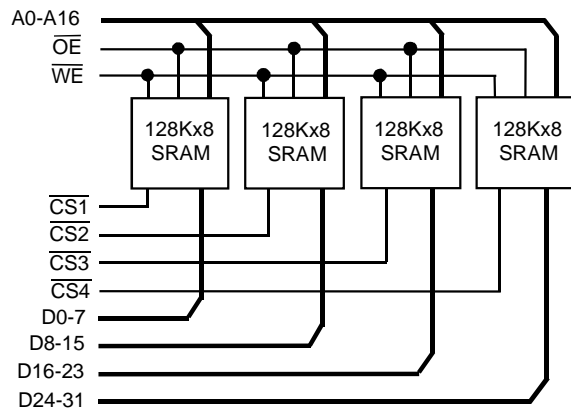

#### Pin Definition

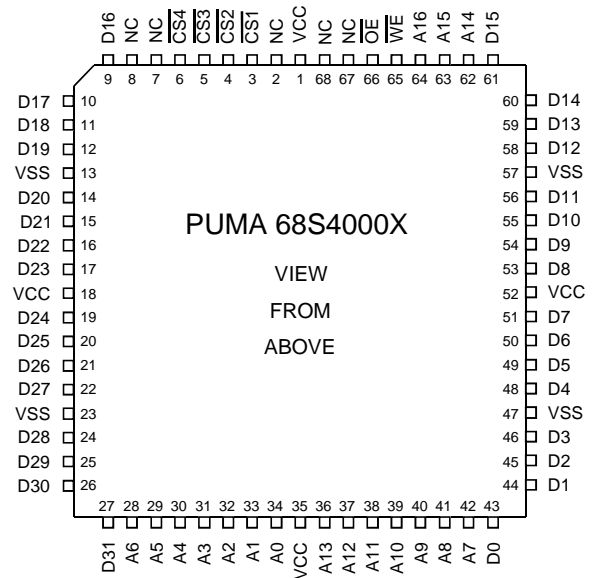

#### Pin Functions

Address Inputs	<b>A0 - A16</b>
Data Input/Output	<b>D0 - D31</b>
Chip Select	<b>CS1-4</b>
Write Enable	<b>WE</b>
Output Enable	<b>OE</b>
No Connect	<b>NC</b>
Power (+5V)	<b>V<sub>CC</sub></b>
Ground	<b>GND</b>

#### Package Details

Plastic 68 J-Leaded JEDEC PLCC

**DC OPERATING CONDITIONS****Absolute Maximum Ratings** <sup>(1)</sup>

Voltage on any pin relative to GND	$V_T$	-0.3 to +7.0	V
Power Dissipation	$P_T$	4.0	W
Storage Temperature	$T_{STG}$	-55 to +125	°C
DC Output Current	$I_{OUT}$	80	mA

Notes (1) Stresses above those listed may cause permanent damage. This is a stress rating only and functional operation of the device at these or any other conditions above those indicated in the operational sections of this specification is not implied. Exposure to absolute maximum rating conditions for extended periods may affect device reliability.

**Recommended Operating Conditions**

Parameter	Symbol	min	typ	max	Units
Supply Voltage	$V_{CC}$	4.5	5.0	5.5	V
Max Terminal Voltage	$V_{TERM}$	-0.3	-	7.0	V
Input High Voltage	$V_{IH}$	2.2	-	$V_{CC}+0.3$	V
Input Low Voltage	$V_{IL}$ <sup>(1)</sup>	-0.3	-	0.8	V
Operating Temperature	$T_A$	0	-	70	°C
	$T_{AI}$	-40	-	85	°C ( Suffix I )

Notes: (1) Pulse width: -3.0V for less than 5ns.

**DC Electrical Characteristics** ( $V_{CC}=5V\pm 10\%$ ,  $T_A=-40^\circ\text{C}$  to  $+85^\circ\text{C}$ )

Parameter	Symbol	Test Condition	min	typ	max	Unit
Input Leakage Current	$I_{LI1}$	$V_{IN}=0V$ to $V_{CC}$	-20	-	20	$\mu\text{A}$
Output Leakage Current	$I_{LO}$	$V_{IO}=0V$ to $V_{CC}$	-40	-	40	$\mu\text{A}$
Operating Supply Current <sup>(2)</sup>	32 bit	$I_{CC32}$ $\overline{CS}^{(1)}=V_{IL}$ , $I_{IO}=0\text{mA}$ , $f=f_{max}$	-	-	840	mA
	16 bit	$I_{CC16}$ As above.	-	-	540	mA
	8 bit	$I_{CC8}$ As above.	-	-	400	mA
Standby Supply Current	(TTL)	$I_{SB}$ $\overline{CS}^{(1)}=V_{IH}$ , $f=f_{max}$ , $V_{IN}=V_{IL}$ or $V_{IH}$	-	-	260	mA
	-L Version (CMOS)	$I_{SB1}$ $\overline{CS}\geq V_{CC}-0.2V$ , $0.2V\geq V_{IN}\geq V_{CC}-0.2V$ , $f=0$	-	-	8	mA
Output Voltage Low	$V_{OL}$	$I_{OL}=8.0\text{mA}$ , $V_{CC}=\text{Min}$	-	-	0.4	V
Output Voltage High	$V_{OH}$	$I_{OH}=-4.0\text{mA}$ , $V_{CC}=\text{Min}$	2.4	-	-	V

Notes: (1)  $\overline{CS}1\sim 4$  inputs operate simultaneously for 32 bit mode, in pairs for 16 bit mode and singly for 8 bit mode.

(2) At  $f=f_{max}$  address and data inputs are cycling at max frequency.

**Capacitance** ( $V_{CC}=5V$ ,  $T_A=25^\circ\text{C}$ ,  $F=1\text{MHz}$ )

Parameter	Symbol	Test Condition	min	typ	max	Unit
Input Capacitance Address, $\overline{OE}$ , $\overline{WE}$	$C_{IN1}$	$V_{IN}=0V$	-	-	34	pF
Output Capacitance 8-bit mode (worst case)	$C_{IO}$	$V_{IO}=0V$	-	-	42	pF

Note: These parameters are calculated, not measured.

**AC Test Conditions** **Output Load**

- \*Input pulse levels: 0.0V to 3.0V
- \*Input rise and fall times: 3 ns
- \*Input and Output timing reference levels: 1.5V
- \* $V_{cc} = 5V \pm 10\%$
- \*PUMA module is tested in 32 bit mode.

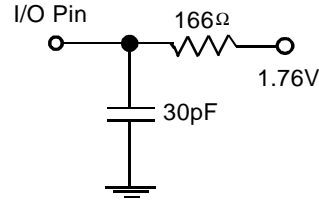

**Operation Truth Table**

$\overline{CS1}$	$\overline{CS2}$	$\overline{CS3}$	$\overline{CS4}$	$\overline{OE}$	$\overline{WE}$	SUPPLY CURRENT	MODE
L	H	H	H	X	L	I <sub>CC8</sub>	Write D0-7
H	L	H	H	X	L	I <sub>CC8</sub>	Write D8-15
H	H	L	H	X	L	I <sub>CC8</sub>	Write D16-23
H	H	H	L	X	L	I <sub>CC8</sub>	Write D24-31
L	L	H	H	X	L	I <sub>CC16</sub>	Write D0-15
H	H	L	L	X	L	I <sub>CC16</sub>	Write D16-31
L	L	L	L	X	L	I <sub>CC32</sub>	Write D0-31
L	H	H	H	L	H	I <sub>CC8</sub>	Read D0-7
H	L	H	H	L	H	I <sub>CC8</sub>	Read D8-15
H	H	L	H	L	H	I <sub>CC8</sub>	Read D16-23
H	H	H	L	L	H	I <sub>CC8</sub>	Read D24-31
L	L	H	H	L	H	I <sub>CC16</sub>	Read D0-15
H	H	L	L	L	H	I <sub>CC16</sub>	Read D16-31
L	L	L	L	L	H	I <sub>CC32</sub>	Read D0-31
X	X	X	X	H	H	I <sub>CC32</sub> /I <sub>CC16</sub> /I <sub>CC8</sub>	D0-31 High-Z
H	H	H	H	X	X	I <sub>SB</sub> , I <sub>SB1</sub>	D0-31 Standby

Notes : H = V<sub>IH</sub> : L = V<sub>IL</sub> : X = V<sub>IH</sub> or V<sub>IL</sub>

**Low Vcc Data Retention Characteristics - L version only**

Parameter	Symbol	Test Condition	min	typ	max	Unit
V <sub>CC</sub> for Data Retention	V <sub>DR</sub>	$\overline{CS} = V_{CC} - 0.2V$	2.0	-	-	V
Data Retention Current	I <sub>CCDR1</sub> <sup>(1)</sup>	V <sub>CC</sub> = 2.0V, $\overline{CS} > V_{CC} - 0.2V$ , V <sub>IN</sub> > 0V	-	-	2.2	mA
Data Retention Time	t <sub>CDR</sub>	See Retention Waveform	0	-	-	ns
Operation Recovery Time	t <sub>R</sub>	See Retention Waveform	t <sub>RC</sub>	-	-	ns

**AC OPERATING CONDITIONS****Read Cycle**

<i>Parameter</i>	<i>Symbol</i>	12		15		20		25		<i>Units</i>
		<i>min</i>	<i>max</i>	<i>min</i>	<i>max</i>	<i>min</i>	<i>max</i>	<i>min</i>	<i>max</i>	
Read Cycle Time	$t_{RC}$	12	-	15	-	20	-	25	-	ns
Address Access Time	$t_{AA}$	-	12	-	15	-	20	-	25	ns
Chip Select Access Time	$t_{ACS}$	-	12	-	15	-	20	-	25	ns
Output Enable to Output Valid	$t_{OE}$	-	7	-	8	-	10	-	13	ns
Output Hold from Address Change	$t_{OH}$	3	-	3	-	3	-	3	-	ns
Chip Selection to Output in Low Z	$t_{CLZ}$	2	-	2	-	3	-	3	-	ns
Output Enable to Output in Low Z	$t_{OLZ}$	0	-	0	-	0	-	0	-	ns
Chip Deselection to Output in High Z	$t_{CHZ}$	0	6	0	8	0	9	0	10	ns
Output Disable to Output in High Z	$t_{OHZ}$	0	5	0	7	0	8	0	10	ns

**Write Cycle**

<i>Parameter</i>	<i>Symbol</i>	12		15		20		25		<i>Units</i>
		<i>min</i>	<i>max</i>	<i>min</i>	<i>max</i>	<i>min</i>	<i>max</i>	<i>min</i>	<i>max</i>	
Write Cycle Time	$t_{WC}$	12	-	15	-	20	-	25	-	ns
Chip Selection to End of Write	$t_{CW}$	10	-	12	-	15	-	20	-	ns
Address Valid to End of Write	$t_{AW}$	10	-	12	-	15	-	20	-	ns
Address Setup Time	$t_{AS}$	0	-	0	-	0	-	0	-	ns
Write Pulse Width	$t_{WP}$	10	-	12	-	15	-	20	-	ns
Write Recovery Time	$t_{WR}$	0	-	0	-	0	-	0	-	ns
Data to Write Time Overlap	$t_{DW}$	7	-	9	-	12	-	15	-	ns
Output Active from End of Write	$t_{OW}$	0	-	0	-	0	-	0	-	ns
Data Hold from Write Time	$t_{DH}$	0	-	0	-	0	-	0	-	ns
Write to Output High Z	$t_{WHZ}$	6	-	-	7	-	10	-	12	ns

**Read Cycle Timing Waveform <sup>(1,2)</sup>**

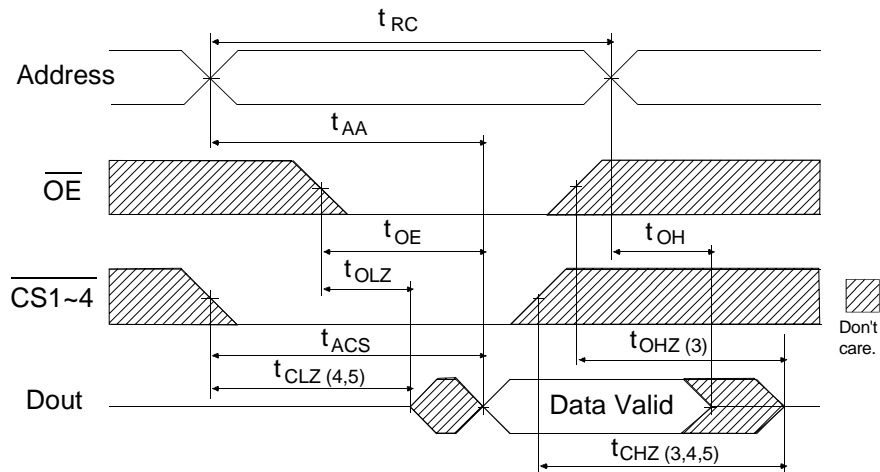

**AC Read Characteristics Notes**

- (1)  $\overline{WE}$  is High for Read Cycle.
- (2) All read cycle timing is referenced from the last valid address to the first transition address.
- (3)  $t_{CHZ}$  and  $t_{OHZ}$  are defined as the time at which the outputs achieve open circuit conditions and are not referenced to output voltage levels.
- (4) At any given temperature and voltage condition,  $t_{CHZ}$  (max) is less than  $t_{CLZ}$  (min) both for a given module and from module to module.
- (5) These parameters are sampled and not 100% tested.

**Write Cycle No.1 Timing Waveform <sup>(1,4)</sup>**

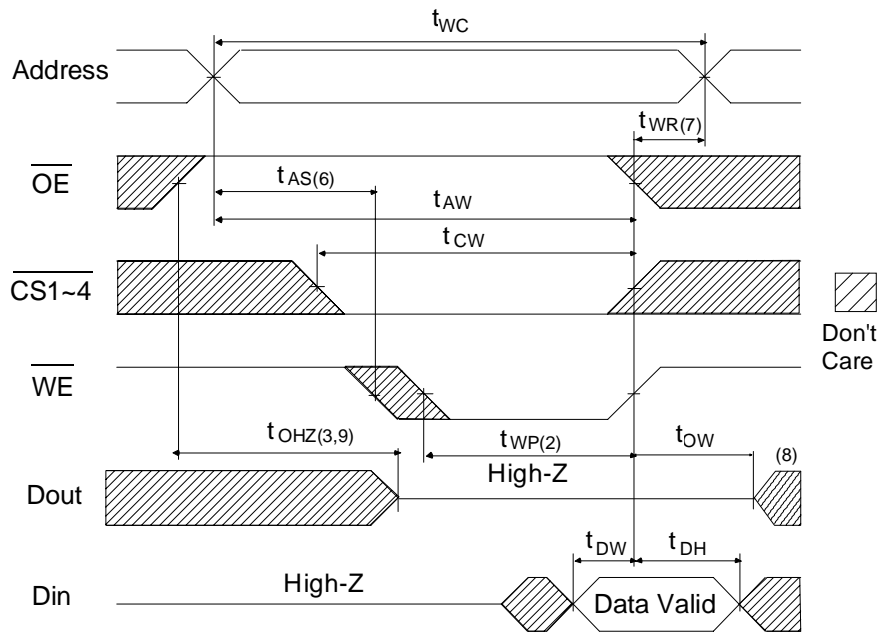



**Package Information**    Dimensions in mm(inches)

**Plastic 68 Pin JEDEC Surface mount PLCC**

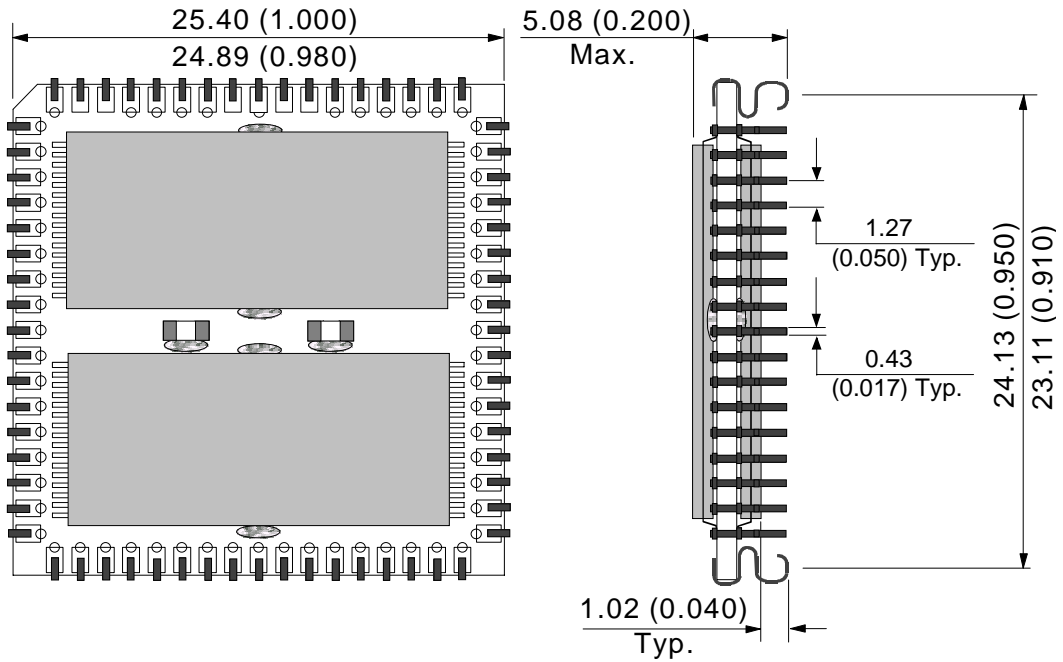

**Ordering Information**

**PUMA 68S4000XLI - 15**

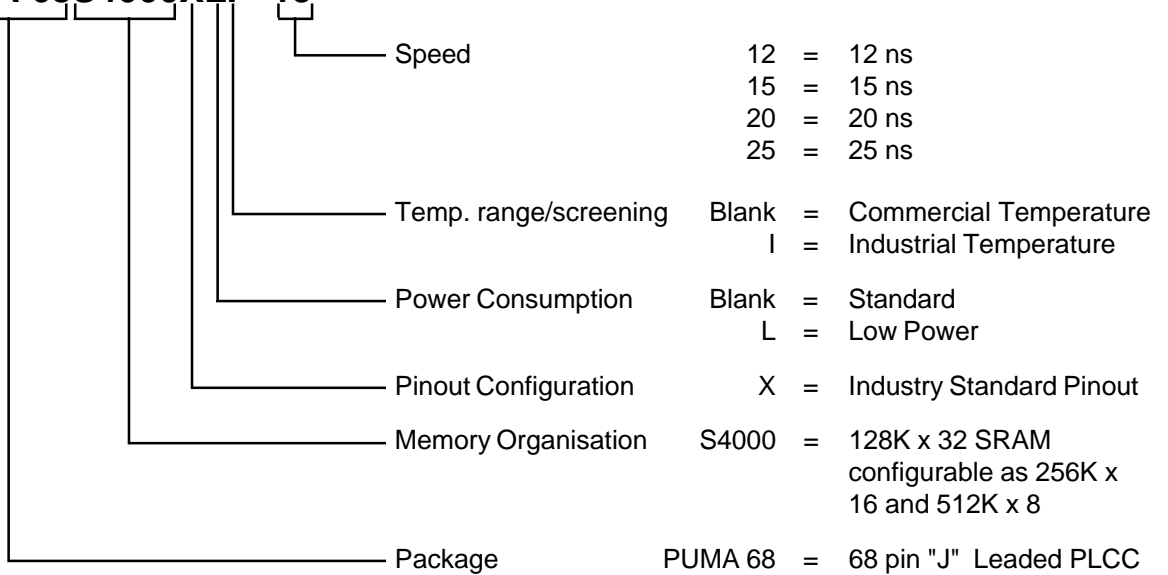

## Soldering Recommendations.

### Bake.

As specified on product packaging.

If not specified HMP Ltd. recommend a minimum bake of 6 hours duration @ 125°C, if parts have been exposed to the atmosphere for 24 hours or more.

### Soldering.

Must not exceed,

VPR 215 - 219°C, 60 secs.

IR / Convection    Ramp Rate 6°C/sec max.  
Temp maintained at 125°C, 120 secs max.  
Temp exceeding 183°C, 120 - 180 secs.  
Time at max. temp. 10 - 40 secs.  
Max temp. 220 +5/-0°C  
Ramp down -6°C/sec max.

### Note :

Although this data is believed to be accurate the information contained herein is not intended to and does not create any warranty of merchantability or fitness for a particular purpose.

Our products are subject to a constant process of development. Data may be changed without notice.

Products are not authorised for use as critical components in life support devices without the express written approval of a company director.