

**TRAILING EDGE PRODUCT - MINIMUM ORDER APPLIES
PRODUCT MAY BE MADE OBSOLETE WITHOUT NOTICE**



512K x 8 SRAM

MSM8512 - 70/85/10

Elm Road, West Chirton, NORTH SHIELDS, Tyne & Wear
NE29 8SE, England Tel. +44 (0191) 2930500 Fax. +44 (0191) 2590997

Issue 4.5 : April 2001

Description

The MSM8512 is a 4Mbit monolithic SRAM organised as 512K x 8 with access times from 70ns to 100ns available. The device is available in a 32 pin ceramic space saving VIL™. The device has a low power standby version which supports data retention mode and is directly TTL compatible. All versions can be screened in accordance with MIL-STD-883C.

524,288 x 8 CMOS Static RAM

Features

- Fast Access Times of 70/85/100 ns
- Average Operating Power 425 mW (max)
- Standby Power 635 μW (max) -L version
- Low voltage data retention.
- Completely Static Operation
- Directly TTL compatible
- May be processed in accordance with MIL-STD-883C

Block Diagram

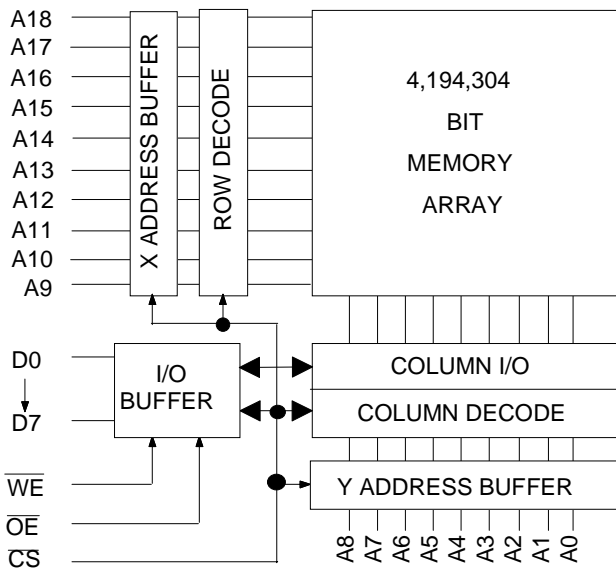

Pin Definition

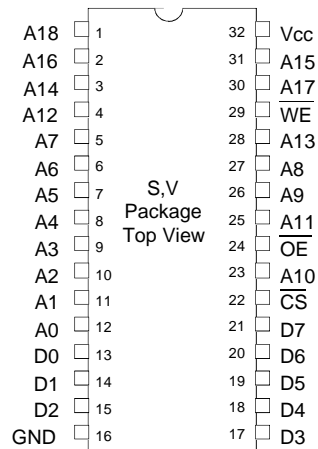

Package Details

Pin Count	Description	Package Type
32	0.1" Vertical-in-line (VIL™)	V

Pin Functions

- A0-A18** Address Inputs
- D0-7** Data Input/Output
- CS** Chip Select
- OE** Output Enable
- WE** Write Enable
- V_{CC}** Power (+5V)
- GND** Ground

DC OPERATING CONDITIONS**Absolute Maximum Ratings** ⁽¹⁾

Voltage on any pin relative to V_{SS} ⁽²⁾	V_T	-0.5	to	+7.0	V
Power Dissipation	P_T			1	W
Storage Temperature	T_{STG}	-55	to	+150	°C

Notes : (1) Stresses above those listed may cause permanent damage to the device. This is a stress rating only and functional operation of the device at these or any other conditions above those indicated in the operational sections of this specification is not implied. Exposure to absolute maximum rating conditions for extended periods may affect device reliability.

Recommended Operating Conditions

Parameter	Symbol	min	typ	max	unit
Supply Voltage	V_{CC}	4.5	5.0	5.5	V
Input High Voltage	V_{IH}	2.2	-	6.0	V
Input Low Voltage	V_{IL}	-0.3	-	0.8	V
Operating Temperature	T_A	0	-	70	°C
	T_{AI}	-40	-	85	°C (I suffix)
	T_{AM}	-55	-	125	°C (M, MB suffix)

DC Electrical Characteristics ($V_{CC} = 5.0V \pm 10\%$, $T_A = -55^\circ C$ to $+125^\circ C$)

Parameter	Symbol	Test Condition	min	typ	max	Unit
Input Leakage Current	I_{LI}	$V_{IN} = 0V$ to V_{CC}	-1	-	1	μA
Output Leakage Current	I_{LO}	$\overline{CS} = V_{IH}$, $V_{IO} = 0V$ to V_{CC} , $\overline{OE} = V_{IH}$ or $\overline{WE} = V_{IL}$	-1	-	1	μA
Average Supply Current	I_{CC1}	$\overline{CS} = V_{IL}$, $I_{IO} = 0mA$, min cycle, duty=100%	-	-	77	mA
Standby Supply Current	I_{SB}	$\overline{CS} = V_{IH}$, $V_{IN} = V_{IH}$ or V_{IL}	-	-	3.5	mA
-L version only	I_{SB1}	$\overline{CS} \geq V_{CC} - 0.2V$, $V_{IN} \geq V_{CC} - 0.2V$ or $0.2V \geq V_{IN}$	-	-	115	μA
Output Voltage	V_{OL}	$I_{OL} = 2.1mA$	-	-	0.4	V
	V_{OH}	$I_{OH} = -1.0mA$	2.4	-	-	V

Capacitance ($V_{CC} = 5V \pm 10\%$, $T_A = 25^\circ C$)

Parameter	Symbol	Test Condition	typ	max	Unit
Input Capacitance:	C_{IN}	$V_{IN} = 0V$	-	8	pF
I/O Capacitance:	C_{IO}	$V_{IO} = 0V$	-	10	pF

Note : This parameter is sampled and not 100% tested.

AC Test Conditions**Output Load**

- * Input pulse levels: 0.8V to 2.2V
- * Input rise and fall times: 5ns
- * Input and Output timing reference levels: 1.5V
- * Output load: See Load Diagram
- * $V_{CC} = 5V \pm 10\%$

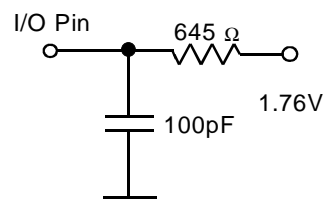

Low V_{CC} Data Retention Characteristics - L Version Only ($T_A = -55^\circ\text{C}$ to $+125^\circ\text{C}$)

Parameter	Symbol	Test Condition	min	typ	max	Unit
V_{CC} for Data Retention	V_{DR}	$\overline{CS} \geq V_{CC} - 0.2\text{V}$	2.0	-	5.5	V
Data Retention Current	I_{CCDR}	$V_{CC} = 3.0\text{V}, \overline{CS} \geq V_{CC} - 0.2\text{V}$,	-	-	290	μA
Chip Deselect to Data Retention	t_{CDR}	See Retention Waveform	0	-	-	ns
Operation Recovery Time	t_R	See Retention Waveform	5	-	-	ms

AC OPERATING CONDITIONS**Read Cycle**

Parameter	Symbol	70		85		10		Units
		min	max	min	max	min	max	
Read Cycle Time	t_{RC}	70	-	85	-	100	-	ns
Address Access Time	t_{AA}	-	70	-	85	-	100	ns
Chip Select Access Time	t_{ACS}	-	70	-	85	-	100	ns
Output Enable to Output Valid	t_{OE}	-	35	-	45	-	50	ns
Output Hold from Address Change	t_{OH}	10	-	10	-	10	-	ns
Chip Selection to Output in Low Z	t_{CLZ}	10	-	10	-	10	-	ns
Output Enable to Output in Low Z	t_{OLZ}	5	-	5	-	5	-	ns
Chip Deselection to Output in High Z ⁽³⁾	t_{CHZ}	0	25	0	30	0	30	ns
Output Disable to Output in High Z ⁽³⁾	t_{OHZ}	0	25	0	30	0	30	ns

Write Cycle

Parameter	Symbol	70		85		10		Unit
		min	max	min	max	min	max	
Write Cycle Time	t_{WC}	70	-	85	-	100	-	ns
Chip Selection to End of Write	t_{CW}	60	-	75	-	80	-	ns
Address Valid to End of Write	t_{AW}	60	-	75	-	80	-	ns
Address Setup Time	t_{AS}	0	-	0	-	0	-	ns
Write Pulse Width	t_{WP}	50	-	55	-	60	-	ns
Write Recovery Time	t_{WR}	0	-	5	-	5	-	ns
Write to Output in High Z	t_{WHZ}	0	30	0	30	0	30	ns
Data to Write Time Overlap	t_{DW}	30	-	35	-	40	-	ns
Data Hold from Write Time	t_{DH}	0	-	0	-	0	-	ns
Output Active from End of Write	t_{OW}	5	-	5	-	5	-	ns
Output Disable to Output in High Z	t_{OHZ}	0	25	0	30	0	30	ns

Write Cycle No.2 Timing Waveform ⁽⁵⁾

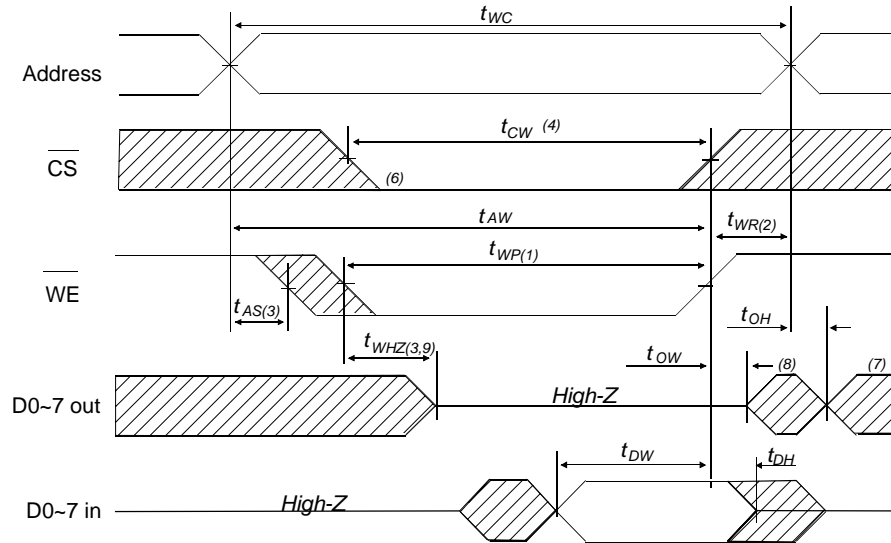

AC Characteristics Notes

- (1) A write occurs during the overlap (t_{WP}) of a low \overline{CS} and a low \overline{WE} .
- (2) t_{WR} is measured from the earlier of \overline{CS} or \overline{WE} going high to the end of write cycle.
- (3) During this period, I/O pins are in the output state. Input signals out of phase must not be applied.
- (4) If the \overline{CS} low transition occurs simultaneously with the \overline{WE} low transition or after the \overline{WE} low transition, outputs remain in a high impedance state.
- (5) \overline{OE} is continuously low. ($\overline{OE}=V_{IL}$)
- (6) D_{OUT} is in the same phase as written data of this write cycle.
- (7) D_{OUT} is the read data of next address.
- (8) If \overline{CS} is low during this period, I/O pins are in the output state. Input signals out of phase must not be applied.
- (9) t_{WHZ} and t_{OHZ} are defined as the time at which the outputs achieve the open circuit conditions and are not referenced to output voltage levels. These parameters are sampled and not 100% tested.

Low V_{CC} Data Retention Timing Waveform

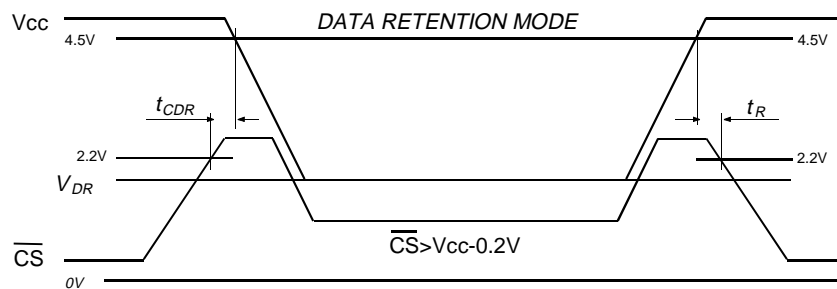

Package Details

32 pin 0.1" Vertical-in-Line (VIL™) - 'V' Package

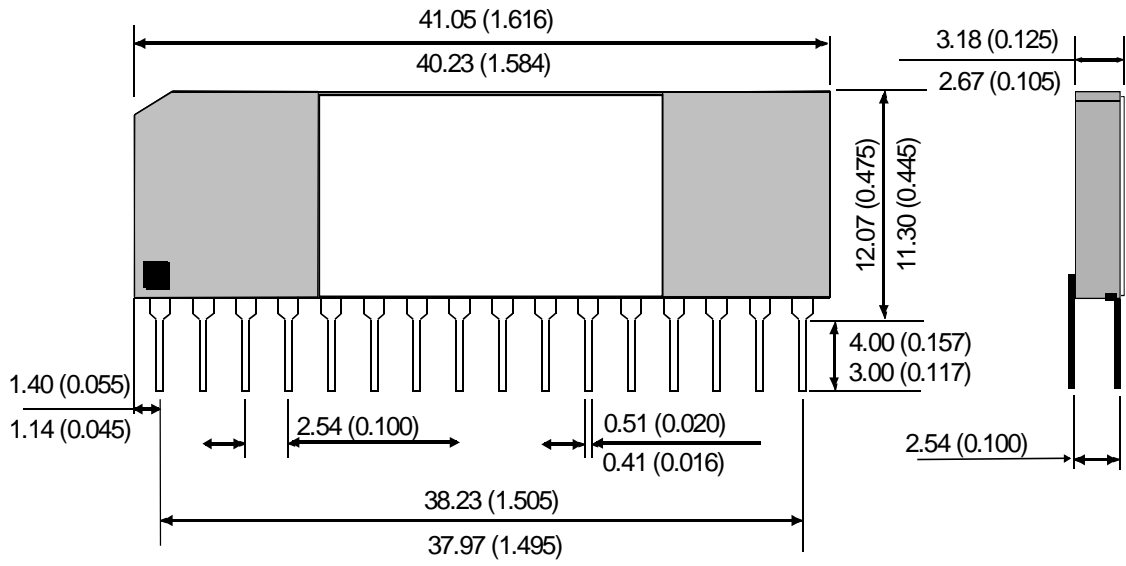

All dimensions in mm (inches).

Military Screening Procedure

Screening Flow for high reliability product in accordance with MIL-STD-883 method 5004 is shown below.

MB COMPONENT SCREENING FLOW		
<i>SCREEN</i>	<i>TEST METHOD</i>	<i>LEVEL</i>
Visual and Mechanical Internal visual Temperature cycle Constant acceleration Pre-Burn-in electrical Burn-in	2010 Condition B or manufacturers equivalent 1010 Condition C (10 Cycles, -65°C to +150°C) 2001 Condition E (Y, only) (30,000g) Per applicable device specifications at $T_A=+25^\circ\text{C}$ Method 1015, Condition D, $T_A=+125^\circ\text{C}$, 160hrs min	100% 100% 100% 100% 100%
Final Electrical Tests Static (dc) Functional Switching (ac)	Per applicable Device Specification a) @ $T_A=+25^\circ\text{C}$ and power supply extremes b) @ temperature and power supply extremes a) @ $T_A=+25^\circ\text{C}$ and power supply extremes b) @ temperature and power supply extremes a) @ $T_A=+25^\circ\text{C}$ and power supply extremes b) @ temperature and power supply extremes	100% 100% 100% 100% 100%
Percent Defective allowable (PDA)	Calculated at post-burn-in at $T_A=+25^\circ\text{C}$	5%
Hermeticity Fine Gross	1014 Condition A Condition C	100% 100%
External Visual	2009 Per vendor or customer specification	100%

Ordering Information

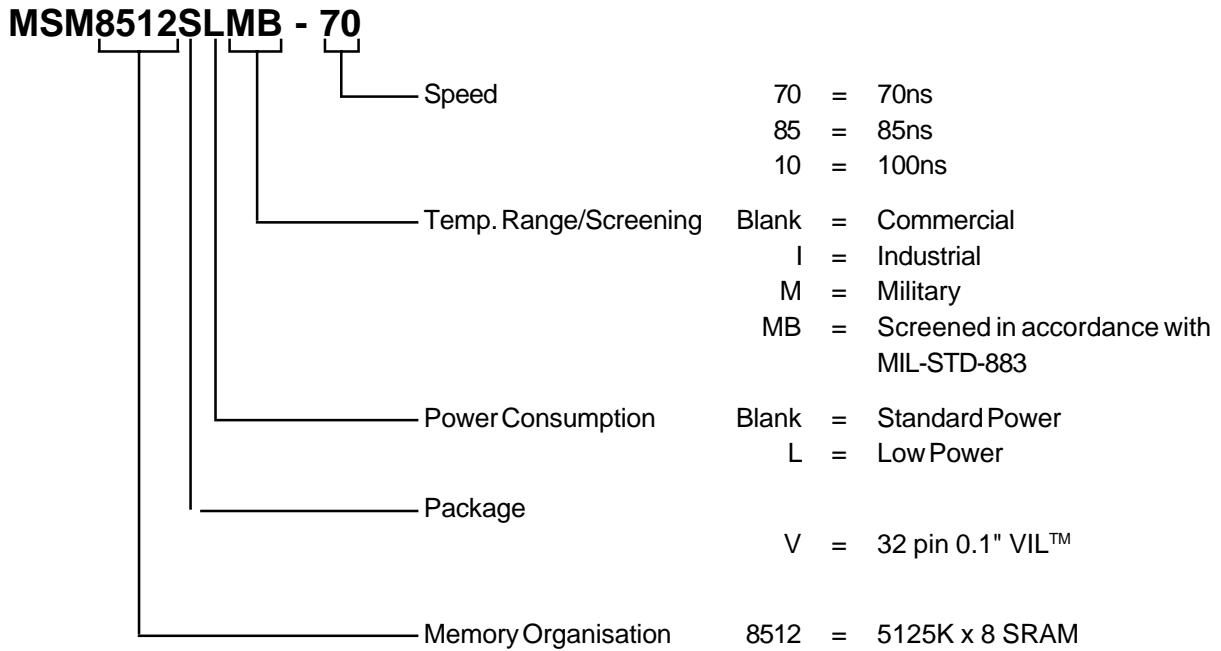

THESE DEVICES ARE NOT RECOMMENDED FOR NEW DESIGNS AND MAY BE MADE OBSOLETE WITHOUT NOTICE....

Although this data is believed to be accurate, the information contained herein, is not intended to and does not create any warranty of merchantability or fitness for a particular purpose. Our products are subject to a constant process of development. Data may be changed at any time without notice. Products are not authorised for use as critical components in life support devices without the express written approval of a company director.