

**TRAILING EDGE PRODUCT - MINIMUM ORDER APPLIES
PRODUCT MAY BE MADE OBSOLETE WITHOUT NOTICE**



32K x 8 SRAM

MSM832 - 70/85/10

Elm Road, West Chirton, NORTH SHIELDS, Tyne & Wear
NE29 8SE, England Tel. +44 (0)191 2930500 Fax. +44 (0) 191 2590997

Issue 4.4 : Nov 1998

Description

The MSM832 is a Static RAM organised as 32K x 8 available with access times of 70,85 or 100 ns. The device is available in three ceramic package options including the high density VIL™ package. It features completely static operation with a low power standby mode and is 3.0V battery back-up compatible. It is directly TTL compatible and has common data inputs and outputs. The device may be screened in accordance with MIL-STD-883.

32,768 x 8 CMOS Static RAM

Features

- Fast Access Times of 70/85/100 ns.
- JEDEC Standard footprint.
- Low Power Operation : 605 mW (max)
- Low Power Standby : 2.53mW (max) -L version.
- Low Voltage Data Retention.
- Directly TTL compatible.
- Completely Static Operation.

Block Diagram

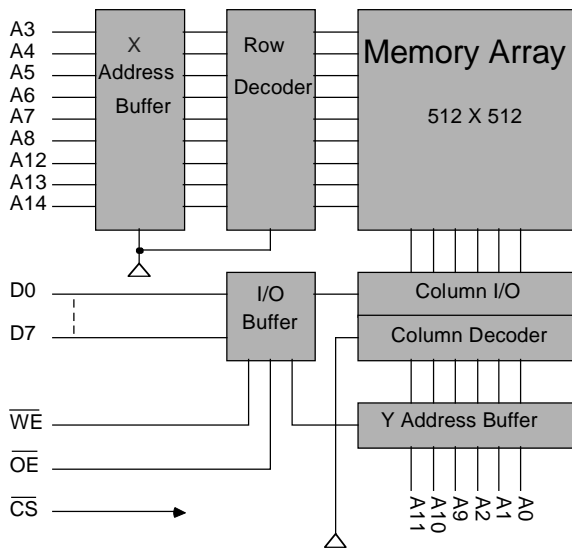

Pin Definitions

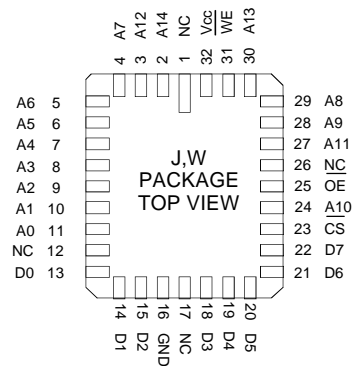
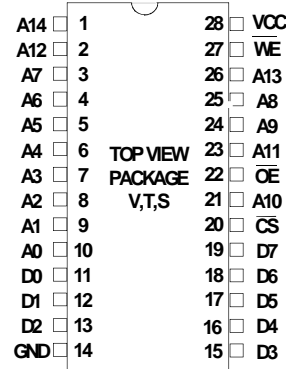

Package Details

Pin Count	Description	Package Type
28	0.1" Vertical-in-Line (VIL™)	V
32	J-Leaded Chip Carrier (JLCC)	J
32	Leadless Chip Carrier (LCC)	W

Pin Functions

- A0-A14** Address inputs
- D0-7** Data Input/Output
- CS** Chip Select
- OE** Output Enable
- WE** Write Enable
- V_{cc}** Power(+5V)
- GND** Ground

DC OPERATING CONDITIONS**Absolute Maximum Ratings** ⁽¹⁾

Voltage on any pin relative to V_{SS} ⁽²⁾	V_T	-0.5V to +7	V
Power Dissipation	P_T	1	W
Storage Temperature	T_{STG}	-65 to +150	°C

Notes : (1) Stresses above those listed may cause permanent damage. This is a stress rating only and functional operation of the device at these or any other conditions above those indicated in the operational sections of this specification is not implied. Exposure to absolute maximum rating conditions for extended periods may affect device reliability.

Recommended Operating Conditions

Parameter	Symbol	min	typ	max	Unit
Supply Voltage	V_{CC}	4.5	5.0	5.5	V
Input High Voltage	V_{IH}	2.2	-	$V_{CC}+0.5$	V
Input Low Voltage	V_{IL}	-0.3	-	0.8	V
Operating Temperature	T_A	0	-	70	°C
	T_{AL}	-40	-	85	°C (Suffix I)
	T_{AM}	-55	-	125	°C (Suffix M, MB)

DC Electrical Characteristics ($V_{CC} = 5.0V \pm 10\%$, $T_A = -55^\circ C$ to $+125^\circ C$)

Parameter	Symbol	Test Condition	min	typ	max	Unit
Input Leakage Current	I_{LI}	$V_{IN}=0V$ to V_{CC}	-4	-	4	μA
Output Leakage Current	I_{LO}	$\overline{CS}=V_{IH}$ or $\overline{OE}=V_{IH}$, $V_{IO}=V_{SS}$ to V_{CC} , $\overline{WE}=V_{IL}$	-4	-	4	μA
Average Supply Current	I_{CC}	$\overline{CS}=V_{IL}$, $I_{IO}=0mA$, Min. Cycle, Duty=100%	-	-	110	mA
Standby Supply Current	I_{SB1}	$\overline{CS}=V_{IH}$, Min Cycle.	-	-	3.5	mA
	-L Version I_{SB2}	$\overline{CS} \geq V_{CC}-0.2V$, $0.2V \geq V_{IN} \geq V_{CC}-0.2V$	-	-	460	μA
Output Voltage	V_{OL}	$I_{OL} = 2.1 mA$	-	-	0.4	V
	V_{OH}	$I_{OH} = -1.0 mA$	2.4	-	-	V

Typical values at $V_{CC}=5.0V$, $T_A=25^\circ C$ and specified loading

Capacitance ($V_{CC}=5V \pm 10\%$, $T_A=25^\circ C$)

Parameter	Symbol	Test Condition	min	typ	max	Unit
Input Capacitance	C_{IN}	$V_{IN} = 0V$	-	-	8	pF
I/O Capacitance	C_{IO}	$V_{IO} = 0V$	-	-	10	pF

Note: This parameter is not 100% tested.

Operating Modes

The table below shows the logic inputs required to control the MSM832 SRAM.

Mode	\overline{CS}	\overline{OE}	\overline{WE}	V_{CC} Current	I/O Pin	Reference Cycle
Not Selected	1	X	X	I_{SB1}, I_{SB2}	High Z	Power Down
OutputDisable	0	1	1	I_{CC}	High Z	
Read	0	0	1	I_{CC}	D_{OUT}	Read Cycle
Write	0	X	0	I_{CC}	D_{IN}	Write Cycle

1 = V_{IH} , 0 = V_{IL} , X = Don't Care

Low V_{CC} Data Retention Characteristics - L Version Only ($T_A = -55^\circ\text{C}$ to $+125^\circ\text{C}$)

Parameter	Symbol	Test Condition	min	typ	max	Unit
V_{CC} for Data Retention	V_{DR}	$\overline{CS} \geq V_{CC} - 0.2\text{V}, V_{IN} \geq 0\text{V}$	2.0	-	-	V
Data Retention Current -L Version	I_{CCDR2}	$V_{CC} = 3.0\text{V}, \overline{CS} \geq V_{CC} - 0.2\text{V}, V_{IN} \geq 0\text{V}$	-	-	700	μA
Chip Deselect to Data Retention Time	t_{CDR}	See Retention Waveform	0	-	-	ns
Operation Recovery Time	t_R	See Retention Waveform	$t_{RC}^{(1)}$	-	-	ns

Notes (1) t_{RC} = Read Cycle Time

AC Test Conditions

- * Input pulse levels: 0V to 3.0V
- * Input rise and fall times: 3ns
- * Input and Output timing reference levels: 1.5V
- * Output load: see diagram
- * $V_{CC} = 5\text{V} \pm 10\%$

Output Load

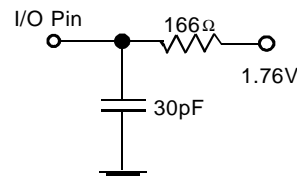

AC OPERATING CONDITIONS**Read Cycle**

<i>Parameter</i>	<i>Symbol</i>	70		85		10		<i>Unit</i>
		<i>min</i>	<i>max</i>	<i>min</i>	<i>max</i>	<i>min</i>	<i>max</i>	
Read Cycle Time	t_{RC}	70	-	85	-	100	-	ns
Address Access Time	t_{AA}	-	70	-	85	-	100	ns
Chip Select Access Time	t_{ACS}	-	70	-	85	-	100	ns
Output Enable to Output Valid	t_{OE}	-	40	-	45	-	50	ns
Output Hold from Address Change	t_{OH}	5	-	5	-	10	-	ns
Chip Selection to Output in Low Z	t_{CLZ}	5	-	10	-	10	-	ns
Output Enable to Output in Low Z	t_{OLZ}	0	-	5	-	5	-	ns
Chip Deselection to Output in High Z ⁽³⁾	t_{CHZ}	0	25	0	30	0	35	ns
Output Disable to Output in High Z ⁽³⁾	t_{OHZ}	0	25	0	30	0	35	ns

Write Cycle

<i>Parameter</i>	<i>Symbol</i>	70		85		10		<i>Unit</i>
		<i>min.</i>	<i>max</i>	<i>min.</i>	<i>max</i>	<i>min</i>	<i>max</i>	
Write Cycle Time	t_{WC}	70	-	85	-	100	-	ns
Chip Selection to End of Write	t_{CW}	65	-	75	-	80	-	ns
Address Valid to End of Write	t_{AW}	65	-	75	-	80	-	ns
Address Setup Time	t_{AS}	0	-	0	-	0	-	ns
Write Pulse Width	t_{WP}	60	-	60	-	60	-	ns
Write Recovery Time	t_{WR}	0	-	0	-	0	-	ns
Write to Output in High Z	t_{WHZ}	0	30	0	30	0	35	ns
Data to Write Time Overlap	t_{DW}	40	-	40	-	40	-	ns
Data Hold from Write Time	t_{DH}	0	-	0	-	0	-	ns
Output Disable to Output in High Z ⁽³⁾	t_{OHZ}	0	25	0	30	0	35	ns
Output Active from End of Write	t_{OW}	5	-	5	-	5	-	ns

Read Cycle Timing Waveform ⁽¹⁾

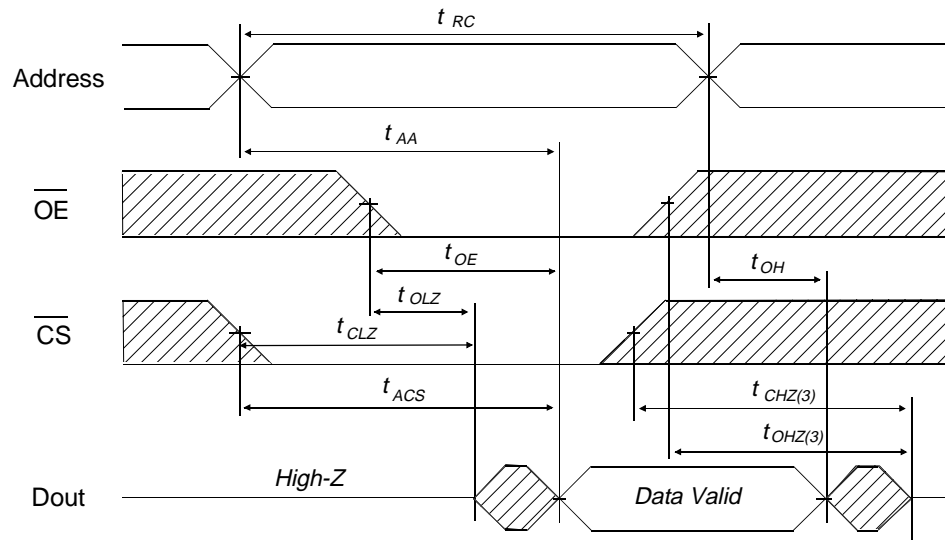

Write Cycle No.1 Timing Waveform

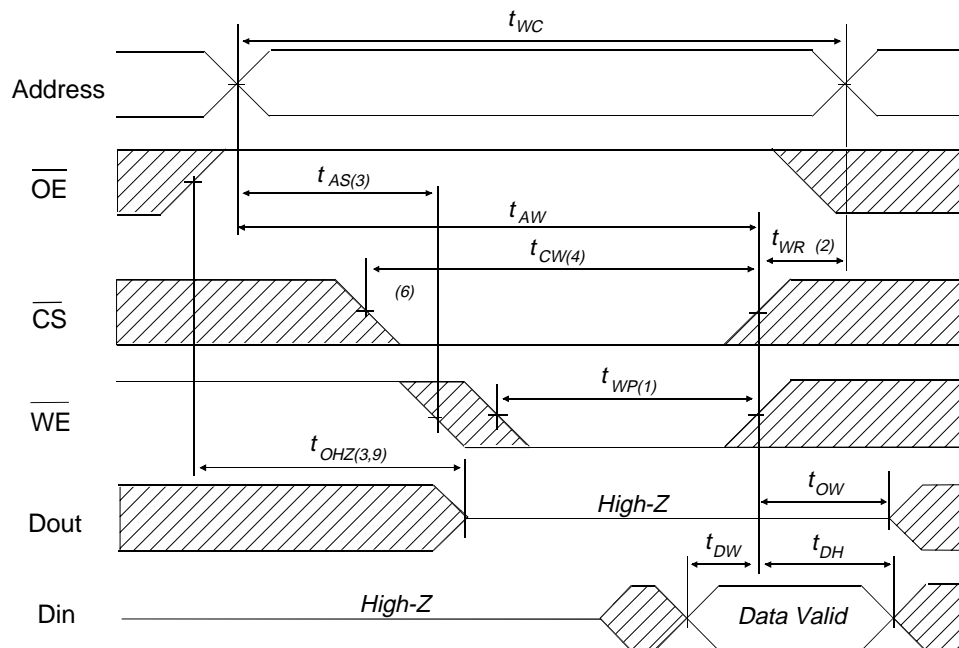

Write Cycle No.2 Timing Waveform ⁽⁵⁾

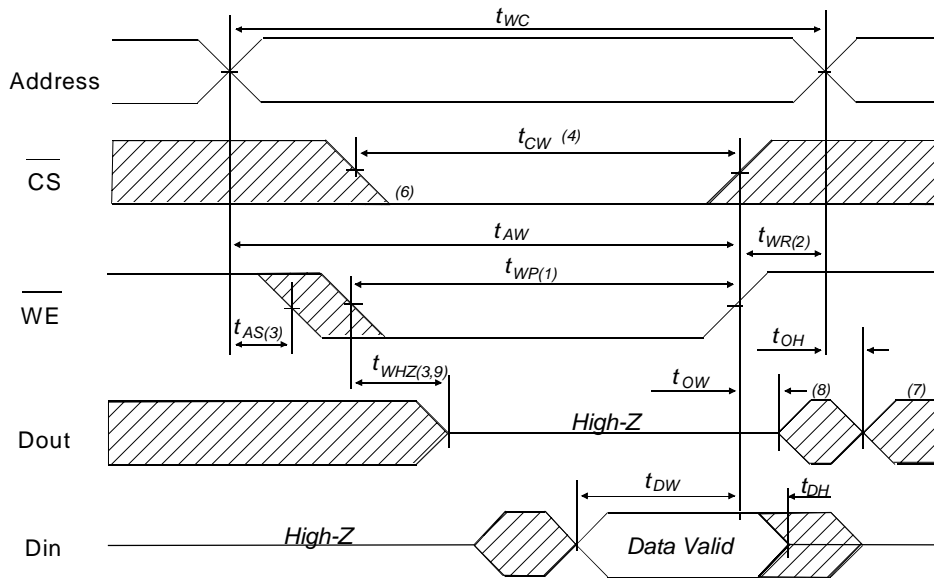

Data Retention Waveform

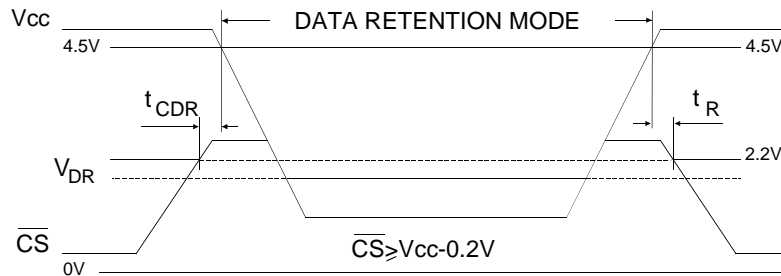

AC Write Characteristics Notes

- (1) A write occurs during the overlap (t_{WP}) of a low \overline{CS} and a low \overline{WE} .
- (2) t_{WR} is measured from the earlier of \overline{CS} or \overline{WE} going high to the end of write cycle.
- (3) During this period, I/O pins are in the output state. Input signals out of phase must not be applied.
- (4) If the \overline{CS} low transition occurs simultaneously with the \overline{WE} low transition or after the \overline{WE} low transition, outputs remain in a high impedance state.
- (5) \overline{OE} is continuously low. ($\overline{OE}=V_{IL}$)
- (6) Dout is in the same phase as written data of this write cycle.
- (7) Dout is the read data of next address.
- (8) If \overline{CS} is low during this period, I/O pins are in the output state. Input signals out of phase must not be applied to I/O pins.
- (9) t_{WHZ} and t_{OHZ} is defined as the time at which the outputs achieve the open circuit conditions and is not referenced to output voltage levels. This parameter is sampled and not 100% tested.

PACKAGE DETAILS dimensions in mm (inches)

28 pin 0.1" Vertical-In-Line (VIL) - 'V' Package

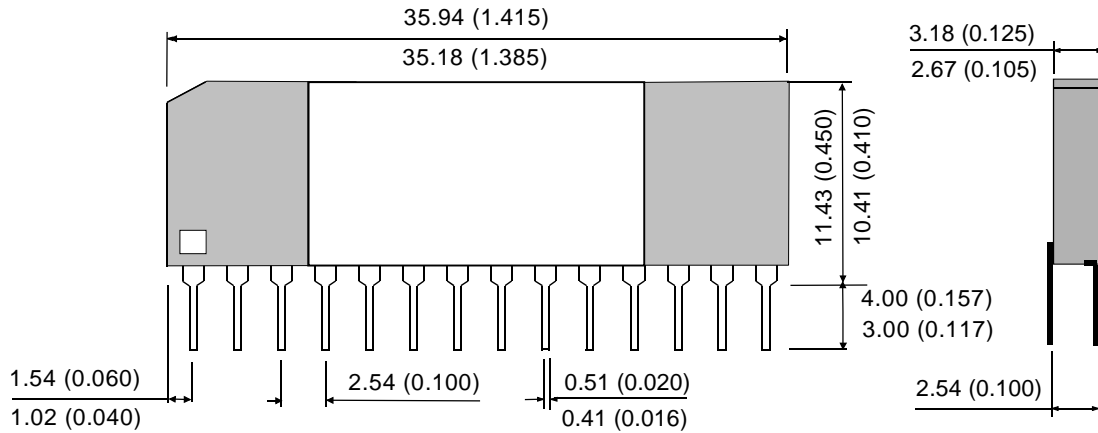

28 pin 0.3" Dual-in-Line (SKINNY) - 'T' Package

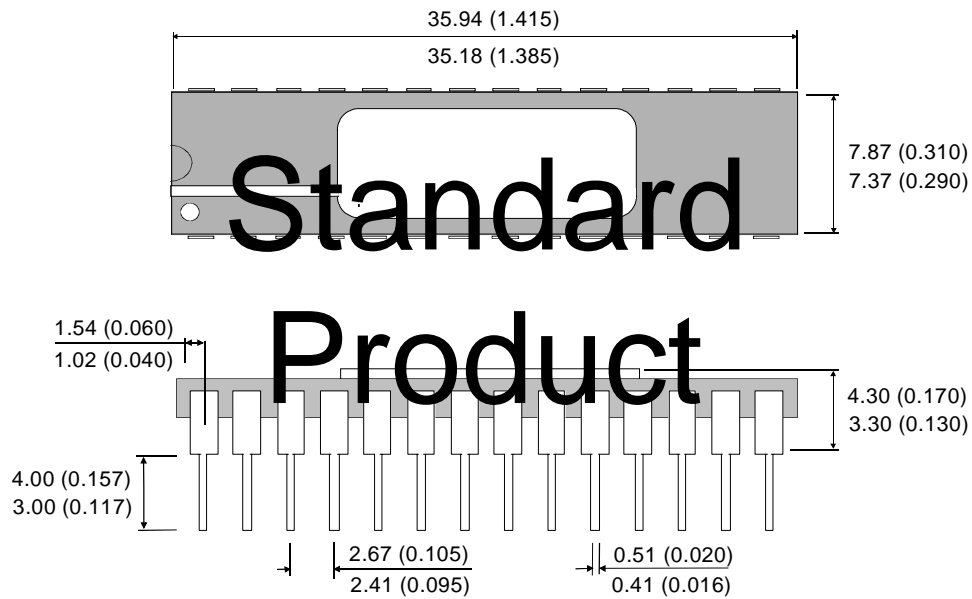

28 pin 0.6" Dual-In-Line (DIL) - 'S' Package

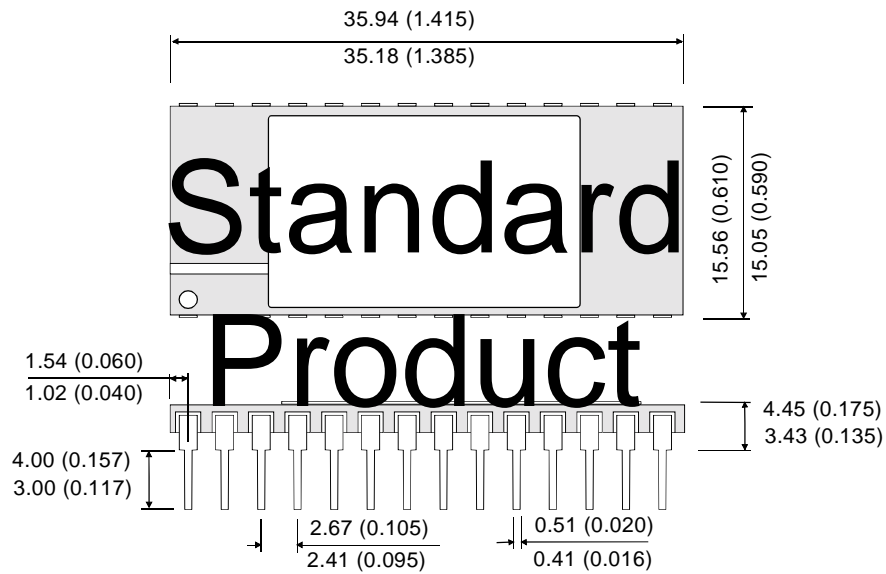

32 pin J-Leaded Chip Carrier - 'J' Package

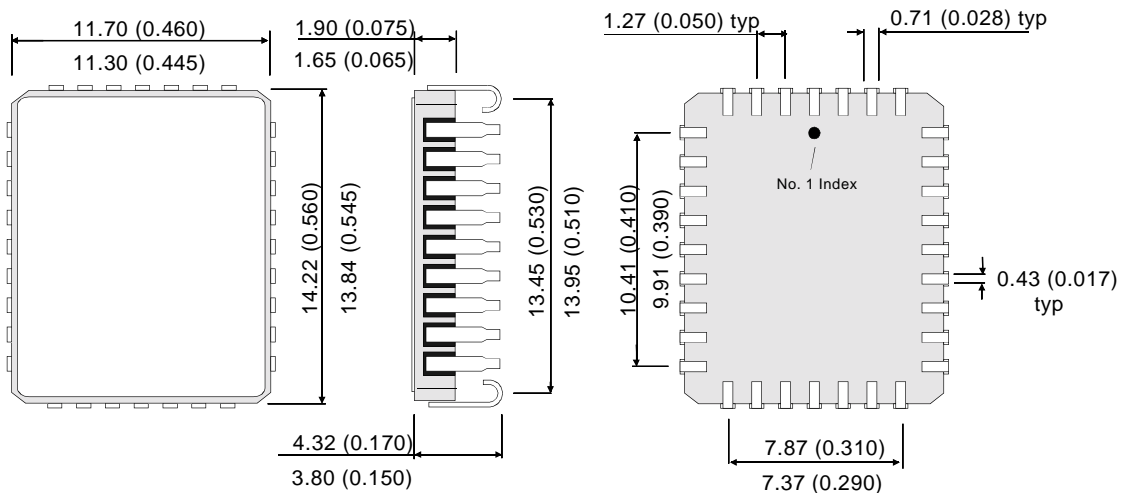

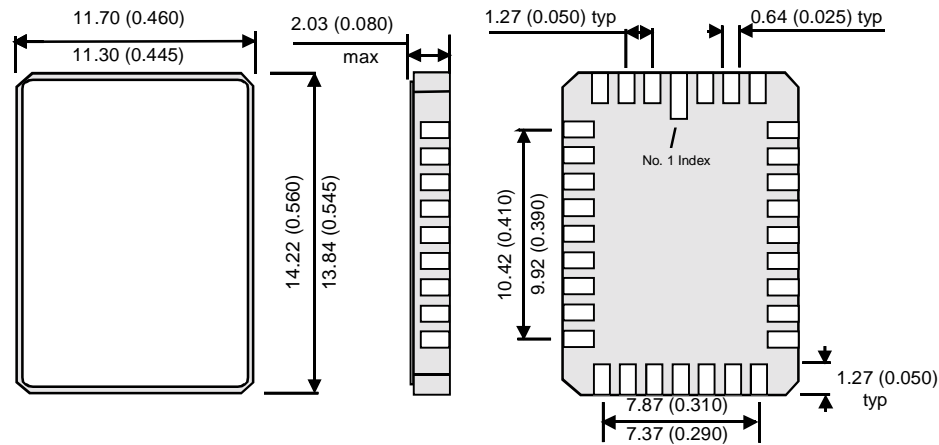
32 pad Leadless Chip Carrier (LCC) - 'W' Package

Minimum Order Product - Consult Factory for details

SCREENING**Military Screening Procedure**

The Component Screening Flow for high reliability parts in accordance with Mil-883 method 5004 is shown below:

MB COMPONENT SCREENING FLOW		
<i>SCREEN</i>	<i>TEST METHOD</i>	<i>LEVEL</i>
Visual and Mechanical		
Internal visual	2010 Condition B or manufacturers equivalent	100%
Temperature cycle	1010 Condition C (10 Cycles, -65°C to +150°C)	100%
Constant acceleration	2001 Condition E (Y, only) (30,000g)	100%
Pre-Burn-in electrical	Per applicable device specifications at $T_A = +25^\circ\text{C}$	100%
Burn-in	Method 1015, Condition D, $T_A = +125^\circ\text{C}$, 160hrs min	100%
Final Electrical Tests	Per applicable Device Specification	
Static (dc)	a) @ $T_A = +25^\circ\text{C}$ and power supply extremes	100%
	b) @ temperature and power supply extremes	100%
Functional	a) @ $T_A = +25^\circ\text{C}$ and power supply extremes	100%
	b) @ temperature and power supply extremes	100%
Switching (ac)	a) @ $T_A = +25^\circ\text{C}$ and power supply extremes	100%
	b) @ temperature and power supply extremes	100%
Percent Defective allowable (PDA)	Calculated at post-burn-in at $T_A = +25^\circ\text{C}$	5%
Hermeticity	1014	
Fine	Condition A	100%
Gross	Condition C	100%
External Visual	2009 Per vendor or customer specification	100%

ORDERING INFORMATION

MSM832SLMB - 85

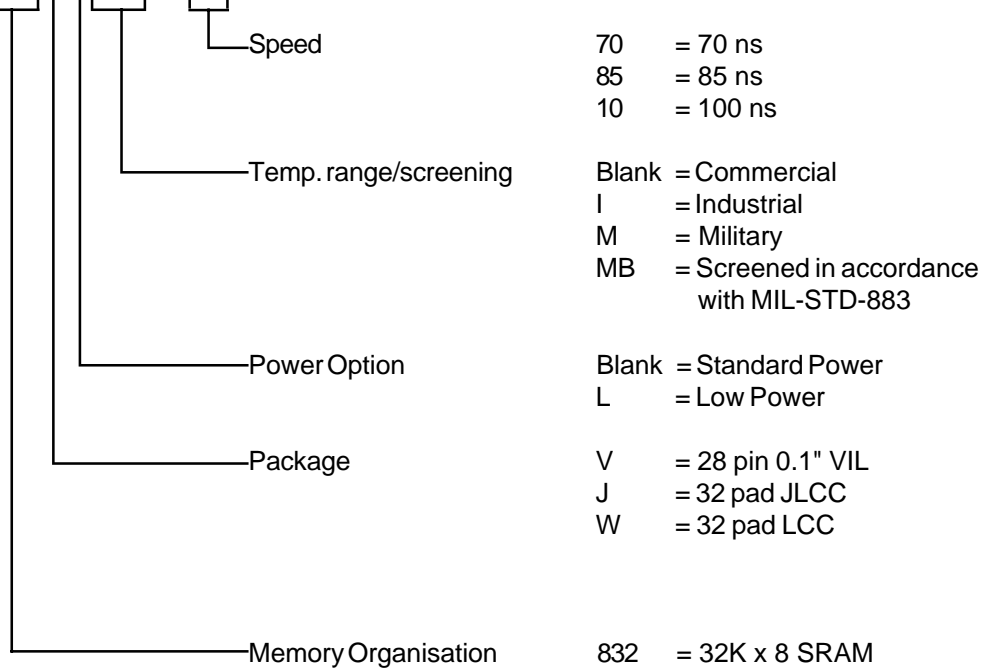

THE MSM832W/J/V ARE NOT RECOMMENDED FOR NEW DESIGNS AND MAY BE MADE OBSOLETE WITHOUT NOTICE....

Although this data is believed to be accurate, the information contained herein is not intended to, and does not create any warranty of merchantability or fitness for a particular purpose. Our products are subject to a constant process of development. Data may be changed at any time without notice. Our products are not authorised for use as critical components in life support devices, or systems without the express written approval of a company director.