



特徴 FEATURES

- **高輝度**
High Brightness
- **小型面実装パッケージ**
Small SMD Package
- **高演色性**
High Color-Rendition

用途 APPLICATIONS

- **表示灯**
Indicators
- **電飾**
Illuminations
- **遊技機器**
Amusement
- **照明**
Lighting

製品概要 PRODUCT SUMMARY

発光色 Emitted Color	チップ Chip	特徴 Features	サイズ(mm) Size
●	1in1	高輝度・高演色性・小型・薄型 / High Brightness・High color-rendering・Small・Thin Type	4.0×1.4 t=0.7

最大定格 MAXIMUM RATINGS

Ta=25°C

Item	逆電圧 Reverse Voltage	順電流 Forward Current	許容損失 Power Dissipation	動作温度 Operating Temp.	保存温度 Storage Temp.	半田付け温度※ Soldering Temp.※
Symbol	Vr	If	Pd	Topr.	Tstg.	Tsol
Unit	V	mA	mW	°C	°C	°C
Data	5	80	280	-40~+85	-40~+100	260

※最大5秒以内
Maximum 5s

電気的光学的特性 ELECTRO-OPTICAL CHARACTERISTICS

Ta=25°C

Item	順電圧 Forward Voltage	色度 Chromaticity Coordinates	光度 Luminous Intensity	光束 Luminous Flux	平均演色性評価値 General Color Rendering Index	指向角 Viewing Angle	順電流条件 IF Conditions
	Min. : Typ. : Max.	(x, y)	Min. : Typ. : Max.	φ V	Min.	2θ 1/2	
Symbol	Vf	(x, y)	Iv	φ V	Ra	2θ 1/2	
Unit	V	-	cd	lm	-	deg	mA
Data	2.8 : 3.05 : 3.5	(0.33, 0.34)	- : 5.0 : -	(14.5)	80	115	60

外形寸法 DIMENSIONS (Unit : mm)

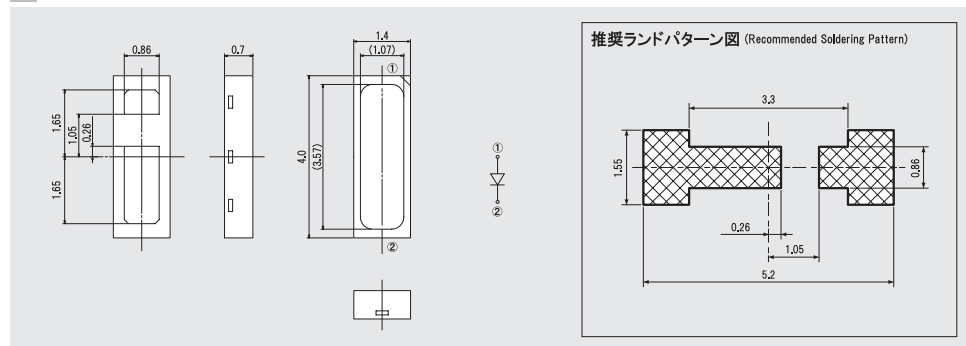

色度ランク分類 CHROMATICITY COORDINATES RANK

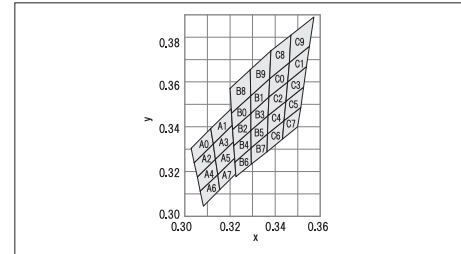

順電流 - 周囲温度特性 Forward current vs. Ambient temperature

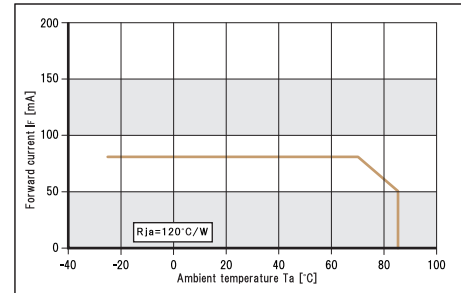

光度 - 順電流特性 Relative luminous intensity vs. Forward current (Ta=25°C)

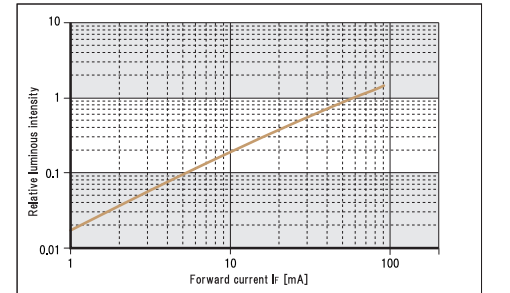

発光波長分布特性 Relative luminous intensity vs. Wavelength

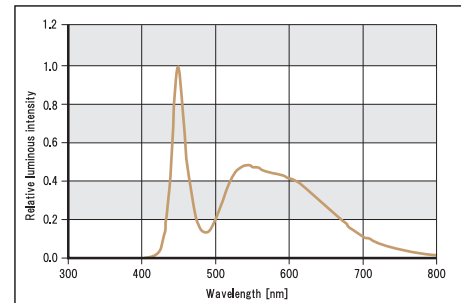

順電流 - 順電圧特性 Forward current vs. Forward voltage (Ta=25°C)

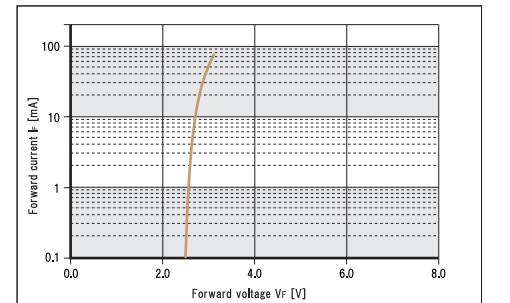

指向特性 Radiation pattern

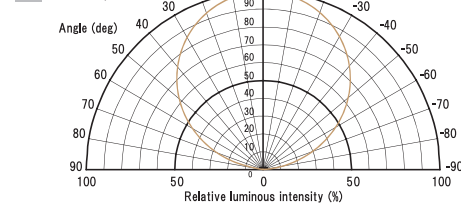

指向特性 Radiation pattern

