



## 特徴 FEATURES

- 高輝度  
High Brightness
- 小型面実装パッケージ  
Small SMD Package

## 用途 APPLICATIONS

- 表示灯  
Indicators
- 電飾  
Illuminations
- 遊技機器  
Amusement
- 照明  
Lighting

## 製品概要 PRODUCT SUMMARY

発光色 Emitted Color	チップ Chip	特徴 Features	サイズ(mm) Size
●	2in1	高輝度・小型・薄型 / High Brightness・Small・ThinType	4.0×1.4 t=0.7

## 最大定格 MAXIMUM RATINGS

Item	逆電圧 Reverse Voltage	順電流 Forward Current	許容損失 Power Dissipation	動作温度 Operating Temp.	保存温度 Storage Temp.	半田付け温度※ Soldering Temp.※
Symbol	V <sub>R</sub>	I <sub>F</sub>	P <sub>D</sub>	T <sub>opr.</sub>	T <sub>stg.</sub>	T <sub>sol</sub>
Unit	V	mA	mW	°C	°C	°C
Data	10	80	592	-40~+85	-40~+100	260

\*最大5秒以内  
Maximum 5s

## 電気的光学的特性 ELECTRO-OPTICAL CHARACTERISTICS

Item	順電圧 Forward Voltage	色度 Chromaticity Coordinates	光度 Luminous Intensity	光束 Luminous Flux	平均演色性評価値 General Color Rendering Index	指向角 Viewing Angle	順電流条件 IF Conditions
	Min. : Typ. : Max.	(x, y)	Min. : Typ. : Max.	φ V	Min.	2θ 1/2	
Symbol	V <sub>F</sub>	(x, y)	I <sub>v</sub>	φ V	R <sub>a</sub>	2θ 1/2	
Unit	V	-	cd	lm	-	deg	mA
Data	5.6 : 6.1 : 7.4	(0.33, 0.34)	- : 11.3 : -	(32.8)	70	115	60

## 外形寸法 DIMENSIONS (Unit : mm)

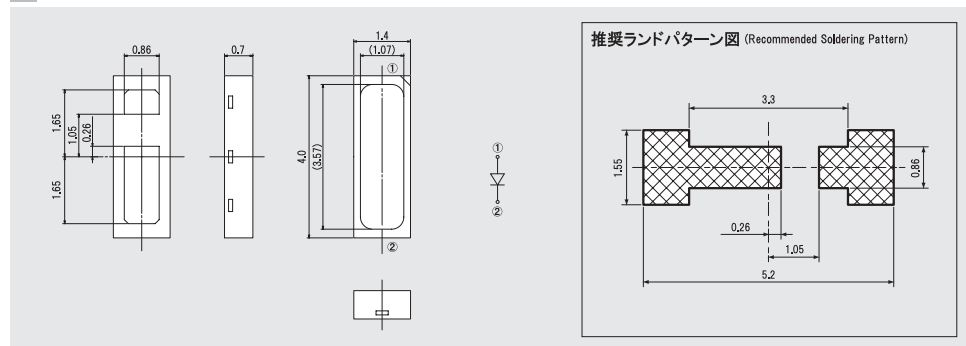

## 色度ランク分類 CHROMATICITY COORDINATES RANK

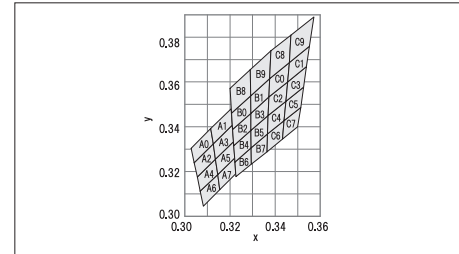

## 順電流 - 周囲温度特性 Forward current vs. Ambient temperature

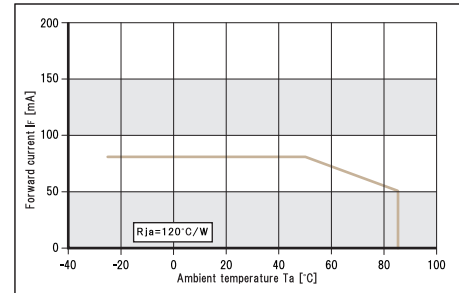

## 光度 - 順電流特性 Relative luminous intensity vs. Forward current (T<sub>a</sub>=25°C)

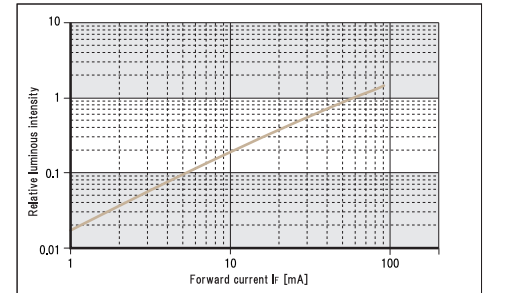

## 発光波長分布特性 Relative luminous intensity vs. Wavelength

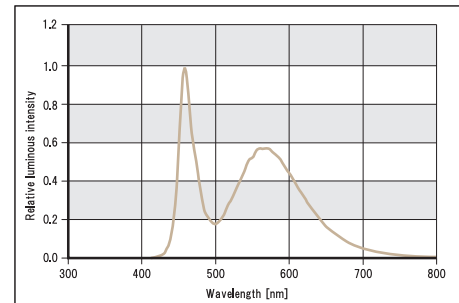

## 順電流 - 順電圧特性 Forward current vs. Forward voltage (T<sub>a</sub>=25°C)

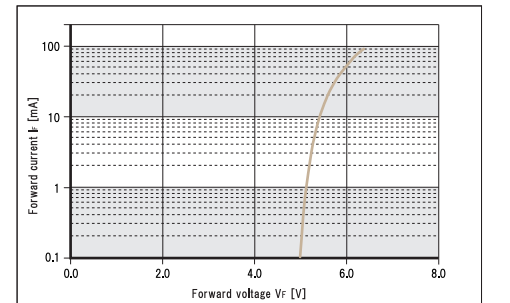

## 指向特性 Radiation pattern

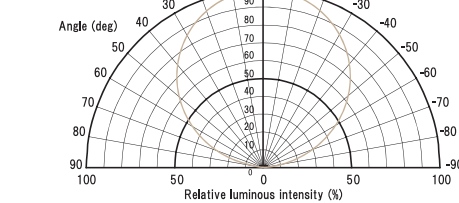

## 指向特性 Radiation pattern

