

CFSH05-20L

**SURFACE MOUNT SILICON
LOW V_F SCHOTTKY DIODE
0.5 AMP, 20 VOLT**



www.centrasemi.com

TLP™
Tiny
Leadless
Package



Top View Bottom View

SOD-882L CASE

DESCRIPTION:

The CENTRAL SEMICONDUCTOR CFSH05-20L is a silicon Schottky diode designed for applications where ultra small package size and energy efficiency are prime requirements. Packaged in the SOD-882L ultra low profile leadless case, this device provides exceptionally low forward voltage characteristics suitable for the most demanding size constrained battery powered applications.

MARKING CODE: 2

APPLICATIONS:

- DC-DC converters
- Voltage clamping
- Protection circuits
- Battery powered hand-held applications including cell phones, digital cameras, tablets and laptop computers

FEATURES:

- Current ($I_O=500mA$)
- Low forward voltage drop ($V_F=220mV$ TYP @ 10mA)
- Low reverse current ($8.0\mu A$ TYP @ 10V)
- Small, ultra low profile 1.0mm x 0.6mm x 0.4mm TLP™ leadless surface mount package

MAXIMUM RATINGS: ($T_A=25^\circ C$)

Peak Repetitive Reverse Voltage
DC Blocking Voltage
Average Forward Current
Peak Forward Surge Current, $t_p=8.3ms$
Power Dissipation
Operating and Storage Junction Temperature
Thermal Resistance

SYMBOL

V_{RRM}	20
V_R	20
I_O	500
I_{FSM}	3.0
P_D	100
T_J, T_{stg}	-65 to +150
θ_{JA}	1000

UNITS

V
V
mA
A
mW
$^\circ C$
$^\circ C/W$

ELECTRICAL CHARACTERISTICS: ($T_A=25^\circ C$ unless otherwise noted)

SYMBOL	TEST CONDITIONS	MIN	TYP	MAX	UNITS
I_R	$V_R=10V$		8.0	30	μA
BV_R	$I_R=500\mu A$	20			V
V_F	$I_F=0.1mA$		100	180	mV
V_F	$I_F=1.0mA$		160	240	mV
V_F	$I_F=10mA$		220	290	mV
V_F	$I_F=100mA$		310	380	mV
V_F	$I_F=500mA$		450	500	mV
C_J	$V_R=1.0V, f=1.0MHz$		21	30	pF

R2 (25-April 2013)

CFSH05-20L

**SURFACE MOUNT SILICON
LOW V_F SCHOTTKY DIODE
0.5 AMP, 20 VOLT**



SOD-882L CASE - MECHANICAL OUTLINE

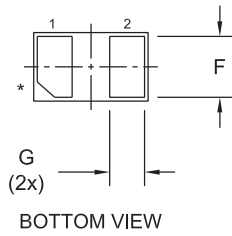
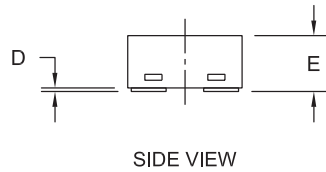
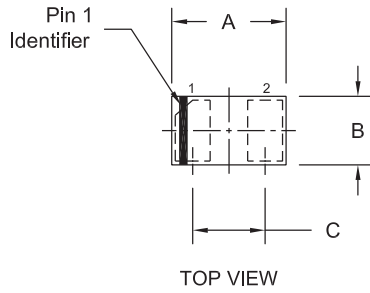

* Pin 1 chamfer may appear on any corner.

SYMBOL	INCHES		MILLIMETERS	
	MIN	MAX	MIN	MAX
A	0.037	0.041	0.95	1.05
B	0.022	0.026	0.55	0.65
C	0.026		0.65	
D	0.000	0.002	0.00	0.05
E	0.012	0.016	0.30	0.40
F	0.018	0.022	0.45	0.55
G	0.008	0.012	0.20	0.30

SOD-882L (REV:R2)

LEAD CODE:

- 1) Cathode
- 2) Anode

MARKING CODE: 2

R2

R2 (25-April 2013)

CFSH05-20L

SURFACE MOUNT SILICON
LOW V_F SCHOTTKY DIODE
0.5 AMP, 20 VOLT



TYPICAL ELECTRICAL CHARACTERISTICS

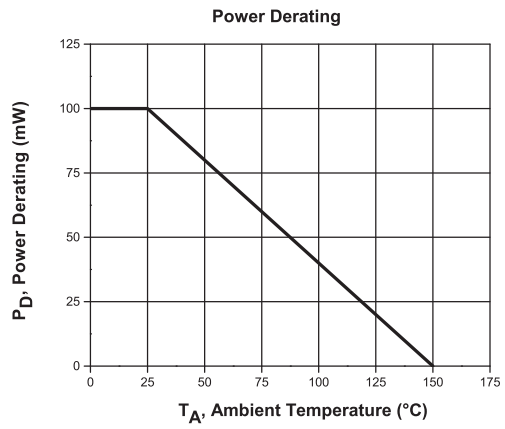
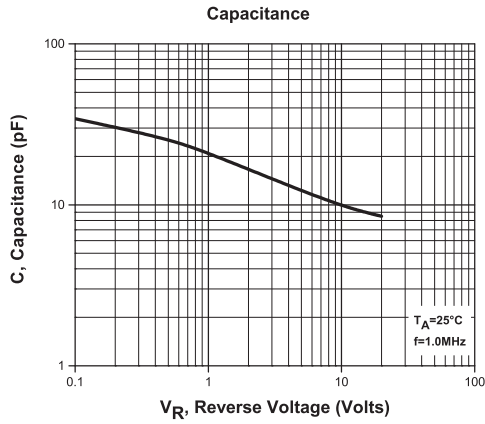
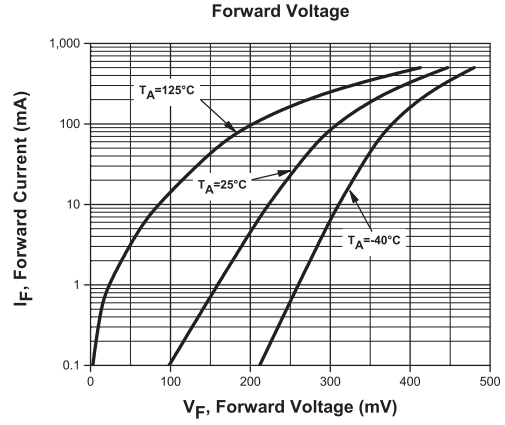
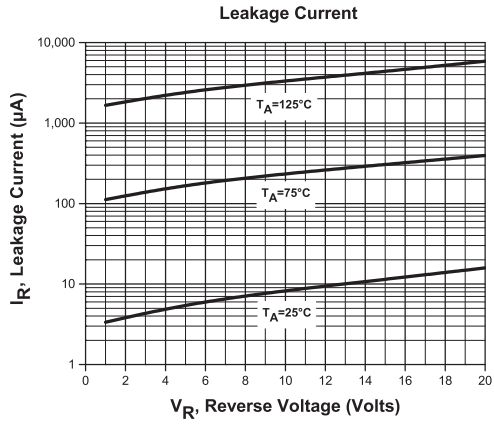

R2 (25-April 2013)