

## SILICON PLANAR HIGH SPEED DIODES

## BAS19, BAS20, BAS21

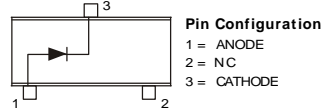
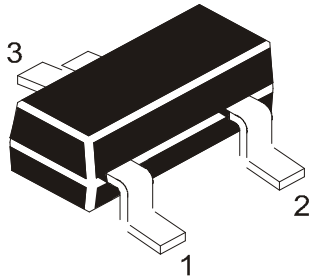

### SOT-23 Formed SMD Package

#### Marking

BAS19 = A8

BAS20 = A81

BAS21 = A82

High-Speed Switching Diodes in a Microminiature Plastic Envelope.

#### ABSOLUTE MAXIMUM RATINGS (Ta=25°C)

DESCRIPTION	SYMBOL	BAS19	BAS20	BAS21	UNIT
Continuous Reverse Voltage	$V_R$	100	150	200	V
Repetitive Peak Reverse Voltage	$V_{RRM}$	120	200	250	V
Non Repetitive Peak Forward Current t=1μs	$I_{FSM}$		2.5		A
t=1s	$I_{FSM}$		0.5		A
Average Rectified Forward Current (averaged over any 20 ms period)	$I_F (AV)$		200		mA
Forward Current (DC)	* $I_F$		200		mA
Repetitive Peak Forward Current	$I_{FRM}$		625		mA
Total Power Dissipation	$P_D$		250		mW
Storage Temperature Range	$T_{stg}$		- 55 to +150		°C
Junction Temperature	$T_j$		150		°C

#### Thermal Resistance

Junction to Ambient in free air	$R_{th(j-a)}$	500	K/W
---------------------------------	---------------	-----	-----

#### ELECTRICAL CHARACTERISTICS (Ta=25° C unless specified otherwise)

DESCRIPTION	SYMBOL	TEST CONDITION	MIN	TYP	MAX	UNIT
Forward Voltage	$V_F$	$I_F=100mA$			1.00	V
		$I_F=200mA$			1.25	V
Reverse Breakdown Voltage	$V_{(BR)R}$	$I_R=100\mu A$				
		**BAS19	120			V
		BAS20	200			V
		***BAS21	250			V

\*Mounted on a ceramic substrate of 8mm x 10mm x 0.7mm

\*\*Measured under pulse conditions; pulse time =  $t_p=0.3ms$ .

\*\*\*At zero life time measured under pulse conditions to avoid excessive dissipation and voltage limited to 275V

BAS19\_21 Rev\_1 050503E

# SILICON PLANAR HIGH SPEED DIODES

BAS19, BAS20, BAS21

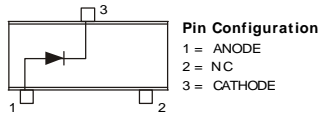
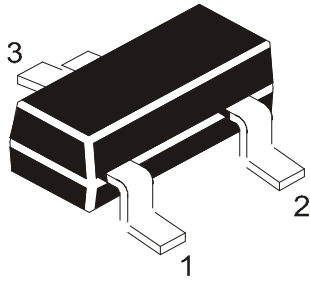

**SOT-23  
 Formed SMD Package**

## ELECTRICAL CHARACTERISTICS (T<sub>a</sub>=25° C unless specified otherwise)

DESCRIPTION	SYMBOL	TEST CONDITION	MIN	TYP	MAX	UNIT
Reverse Voltage Leakage Current	I <sub>R</sub>	V <sub>R</sub> = V <sub>Rmax</sub>			100	nA
		V <sub>R</sub> = V <sub>Rmax</sub> T <sub>j</sub> = 150°C			100	μA
Differential Resistance	r <sub>diff</sub>	I <sub>F</sub> = 10mA		5		Ω
Reverse Recovery Time When Switched from	t <sub>rr</sub>	I <sub>F</sub> = 30mA to I <sub>R</sub> = 30mA, R <sub>L</sub> 100 Ω, measured at I <sub>R</sub> = 3mA			50	ns

BAS19\_21 Rev\_1 050503E

**SOT-23  
Formed SMD Package**

**SOT-23 Formed SMD Package**

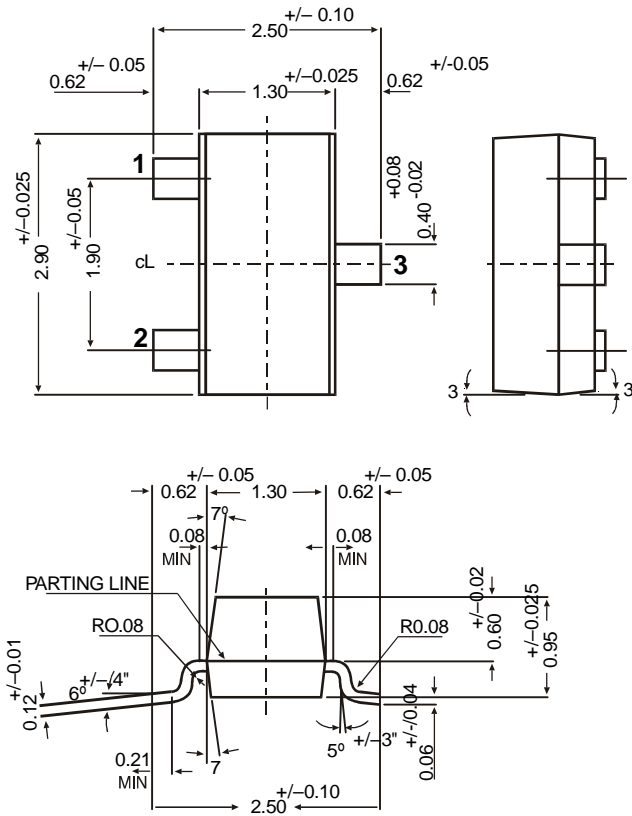

**SOT-23 Package Reel Information  
Reel specifications for Packing (13"/7" reels)**

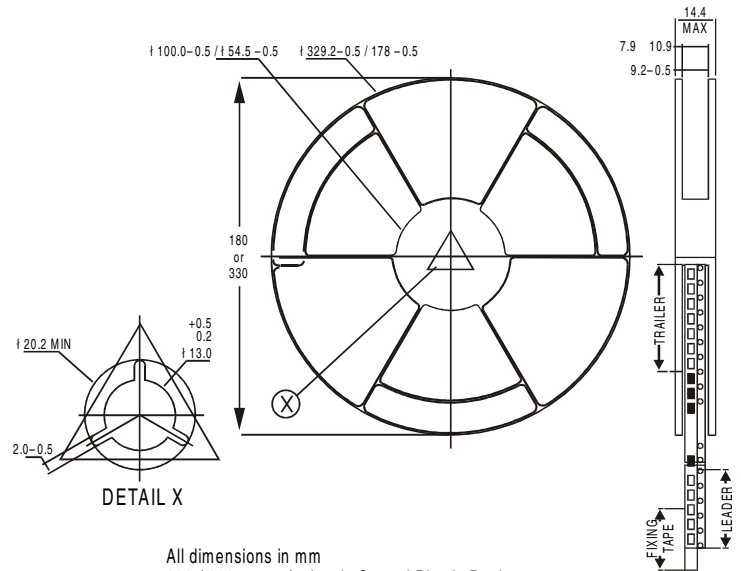

All dimensions in mm  
330 / 180 mm Antistatic Coated Plastic Reel

NOTES:

No. of Devices	8mm Tape Size of Reel 330 mm (13") 10,000 Pcs	8mm Tape Size of Reel 180 mm (7") 3,000 Pcs
----------------	--	--

- The bandoler of 330 mm reel contains at least 10,000 devices.
- The bandoler of 180 mm reel contains at least 3,000 devices.
- No more than 0.5% missing devices / reel. 50 empty compartments for 330 mm reel. 15 empty compartments for 180 mm reel.
- Three consecutive empty places might be found provided this gap is followed by 6 consecutive devices.
- The carrier tape (leader) starts with at least 75 empty positions (equivalent to 330 mm). In order to fix the carrier tape a self adhesive tape of 20 to 50 mm is applied. At the end of the bandoler at least 40 empty positions (equivalent to 160 mm) are there.

**Tape Specification for SOT-23 Surface Mount Device**

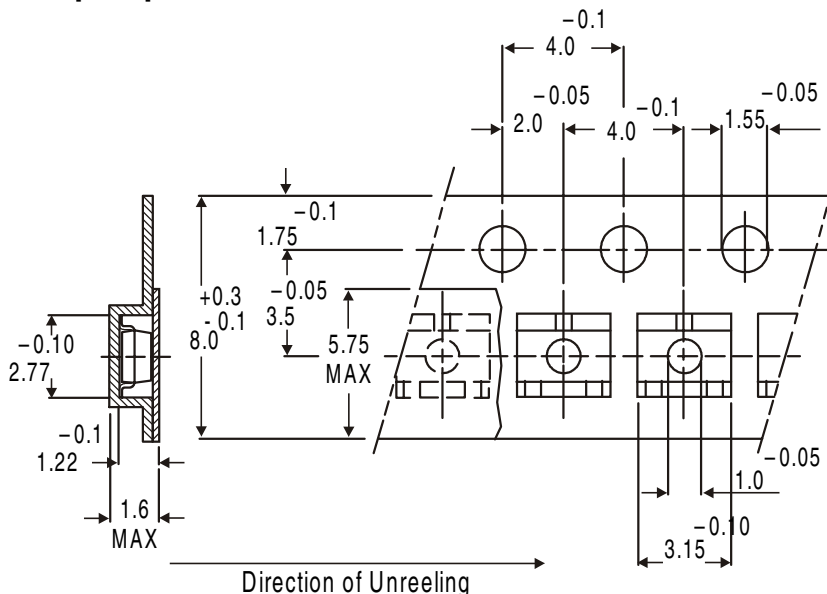

Direction of Unreeling

All dimensions in mm

## Packing Detail

PACKAGE	STANDARD PACK		INNER CARTON BOX		OUTER CARTON BOX		
	Details	Net Weight/Qty	Size	Qty	Size	Qty	Gr Wt
SOT-23 T&R	3K/reel	136 gm/3K pcs	3" x 7.5" x 7.5"	12.0K	17" x 15" x 13.5"	192.0K	12 kgs
			9" x 9" x 9"	51.0K	19" x 19" x 19"	408.0K	28 kgs
	10K/reel	415 gm/10K pcs	13" x 13" x 0.5"	10.0K	17" x 15" x 13.5"	300.0K	16 kgs

## Customer Notes

### Component Disposal Instructions

1. CDIL Semiconductor Devices are RoHS compliant, customers are requested to please dispose as per prevailing Environmental Legislation of their Country.
2. In Europe, please dispose as per EU Directive 2002/96/EC on Waste Electrical and Electronic Equipment (WEEE).

## Disclaimer

The product information and the selection guides facilitate selection of the CDIL's Discrete Semiconductor Device(s) best suited for application in your product(s) as per your requirement. It is recommended that you completely review our Data Sheet(s) so as to confirm that the Device(s) meet functionality parameters for your application. The information furnished on the CDIL Web Site/CD are believed to be accurate and reliable. CDIL however, does not assume responsibility for inaccuracies or incomplete information. Furthermore, CDIL does not assume liability whatsoever, arising out of the application or use of any CDIL product; neither does it convey any license under its patent rights nor rights of others. These products are not designed for use in life saving/support appliances or systems. CDIL customers selling these products (either as individual Discrete Semiconductor Devices or incorporated in their end products), in any life saving/support appliances or systems or applications do so at their own risk and CDIL will not be responsible for any damages resulting from such sale(s).

CDIL strives for continuous improvement and reserves the right to change the specifications of its products without prior notice.



CDIL is a registered Trademark of  
**Continental Device India Limited**

C-120 Naraina Industrial Area, New Delhi 110 028, India.

Telephone + 91-11-2579 6150, 4141 1112 Fax + 91-11-2579 5290, 4141 1119  
 email@cdil.com www.cdilsemi.com