

DATA SHEET  
CLL020-1204A1-403M1A2



**CITIZEN** and **CITIZEN** Micro HumanTech are trademarks or registered trademarks of CITIZEN HOLDINGS CO., LTD. JAPAN.  
**CITILED** is a trademark or a registered trademark of CITIZEN ELECTRONICS CO., LTD. JAPAN.

# DATA SHEET

1/11

## 1. Scope of Application

This data sheet is applied to the LED package, model CLL020-1204A1-403M1A2.

## 2. Part code

CLL 020 - 12 04 A1 - 40 3 M1 A2  
[1] [2] [3] [4] [5] [6]

[1] Part Code

[2] Dies in series quantity

[3] Dies in parallel quantity

[4] Correlated color temperature

[5] Chromaticity range

[6] CRI

## < Features >

- **External Dimensions:** 13.5×13.5×1.4 mm
- **Internal Structure:** Aluminum Base Chip on Board
- **Connection to Heat Sink:** By M3 screw (Recommended)
  
- **Luminous Flux:** 910 lm @ 240 mA
- **CCT:** 4000 K (ANSI C78.377 Compliant, in 3-Step MacAdam Ellipse)
- **CRI:** Ra 80 min.
- **Thermal Resistance:** 2.1 C/W
  
- **RoHS Compliant**

Symbol	CITLED
Name	CLL020-1204A1-403M1A2
CITIZEN ELECTRONICS CO.,LTD. JAPAN	

3. Outline drawing - Marking

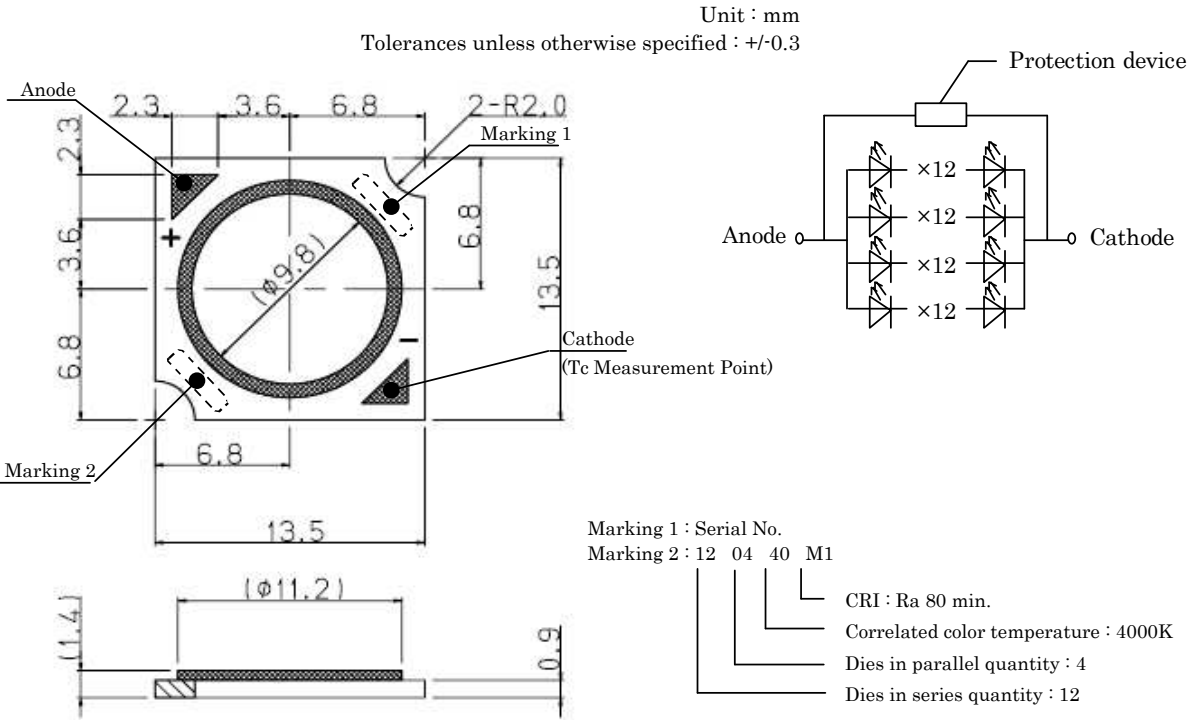

4. Performance

(1) Absolute Maximum Rating

Parameter	Symbol	Rating Value	Unit	
Input Power	P <sub>i</sub>	21.4	W	*1
Forward Current	I <sub>F</sub>	480	mA	*1
Reverse Current	I <sub>R</sub>	1	mA	
Operating Temperature	T <sub>op</sub>	-30 ~ +85	C	
Storage Temperature	T <sub>st</sub>	-40 ~ +100	C	
Case Temperature	T <sub>c</sub>	100	C	*2
Junction Temperature	T <sub>j</sub>	150	C	*3

\*1 Input power and forward current are the values when the LED is used within the range of the derating curve in this data sheet.

\*2 Refer to 3. Outline drawing for T<sub>c</sub> measurement point

\*3 D.C. Current : T<sub>j</sub> = T<sub>c</sub> + R<sub>j-c</sub> X P<sub>i</sub>

Symbol	CITILED
Name	CLL020-1204A1-403M1A2
CITIZEN ELECTRONICS CO.,LTD. JAPAN	

# DATA SHEET

3/11

## (2) Electro-optical Characteristics

T<sub>c</sub>=25C

Parameter	Symbol	Condition	Min.	Typ.	Max	Unit
Forward Voltage	V <sub>F</sub>	I <sub>F</sub> =240mA	33.6	36.6	39.9	V
Luminous Flux	Φ <sub>V</sub>	I <sub>F</sub> =240mA	775	910	-	lm
CRI	R <sub>a</sub>	I <sub>F</sub> =240mA	80	-	-	-
Thermal Resistance	R <sub>j-c</sub>	Junction-Case	-	2.1	-	C/W

Chromaticity coordinates ( Condition : I<sub>F</sub>=240mA, T<sub>c</sub> = 25C)

Center	
x	y
0.3818	0.3797
Oval parameter	
a	0.00939
b	0.00402
θ°	54.00

Reference (ANSI C78.377)

		x	y
4000K	Center	0.3818	0.3797
	a	0.4006	0.4044
	b	0.3736	0.3874
	c	0.3670	0.3578
	d	0.3898	0.3716

\*Color region stay within MacAdam "3-step" ellipse from the chromaticity center.

\*The chromaticity center refers to ANSI C78.377:2008.

Please refer to ANSI C78.377 for the chromaticity center.

\*θ is the angle between the major axis of the ellipse and the x-axis,

and a and b are the major and minor semi-axes of an ellipse. (Ref. IEC 60081:1997 AnnexD)

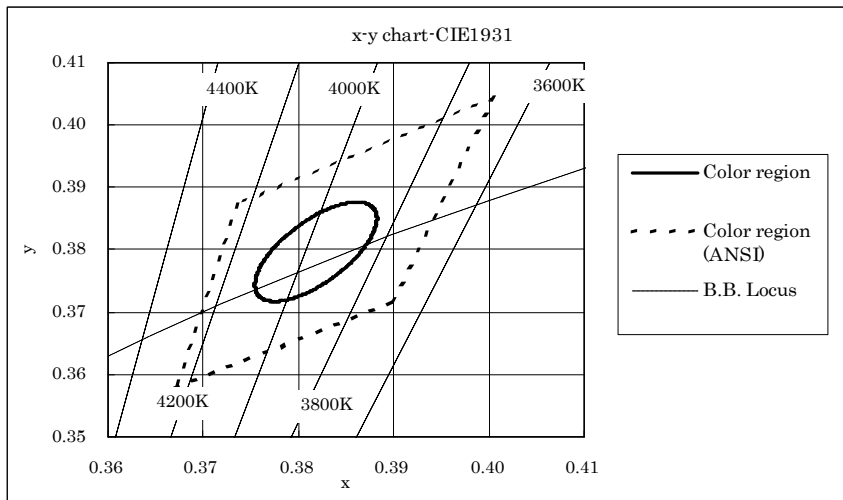

Note: The tolerance of measurement at our tester is V<sub>F</sub>±3% , Φ<sub>v</sub>±10% , Chromaticity(x,y)±0.005 and R<sub>a</sub>±1.

Symbol	CITLED
Name	CLL020-1204A1-403M1A2
CITIZEN ELECTRONICS CO.,LTD. JAPAN	

5. Characteristics

Forward Current vs. Forward Voltage

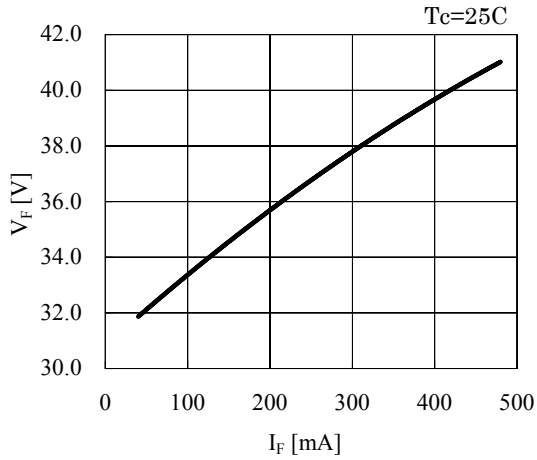

Forward Current vs. Relative Luminous Flux

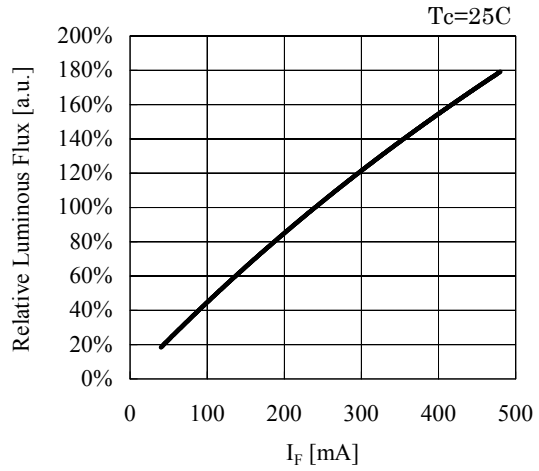

Forward Current vs. Chromaticity Coordinate

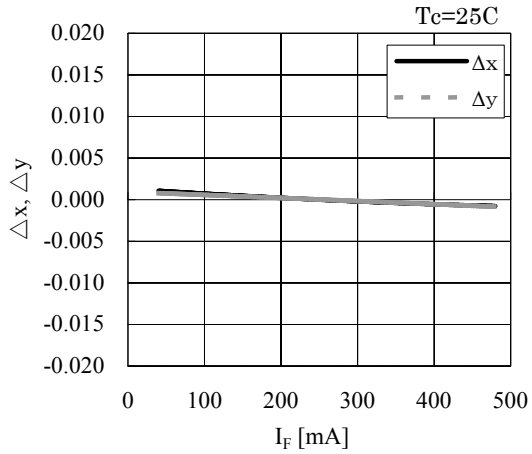

Case Temperature vs. Chromaticity Coordinate

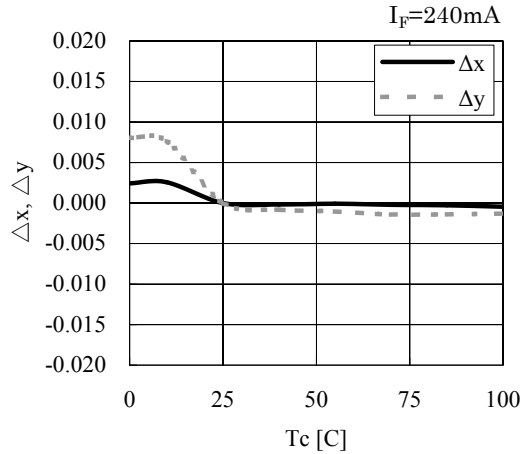

Symbol	CITLED
Name	CLL020-1204A1-403M1A2
CITIZEN ELECTRONICS CO.,LTD. JAPAN	

# DATA SHEET

5/11

Case Temperature vs. Forward Voltage  
 $I_F=240\text{mA}$

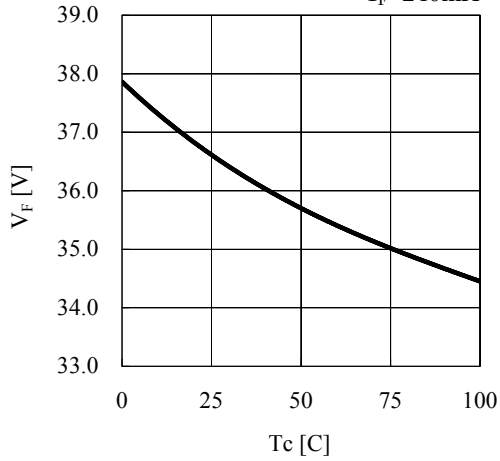

Case Temperature vs. Relative Luminous Flux  
 $I_F=240\text{mA}$

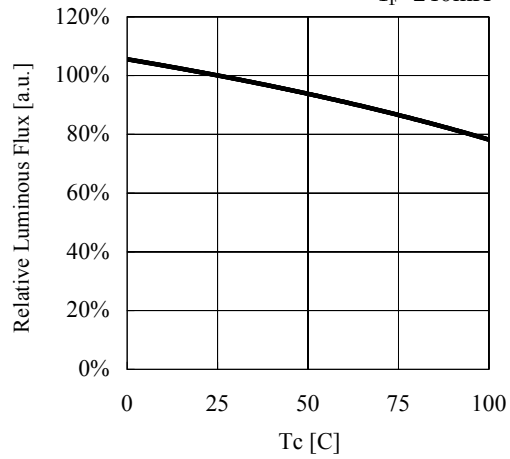

Case Temperature vs. Allowable Forward Current

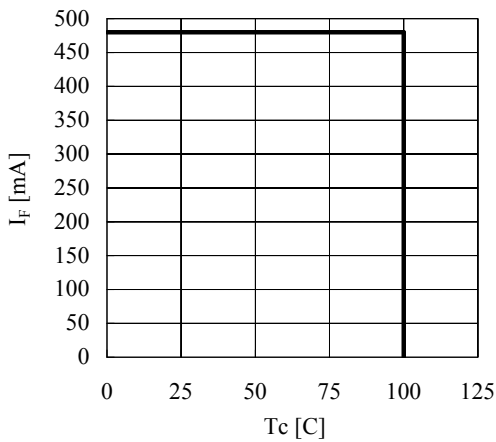

Spectrum

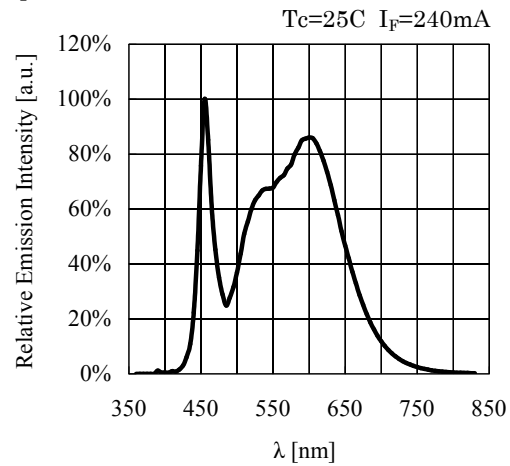

Directive Characteristic

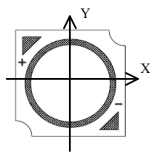
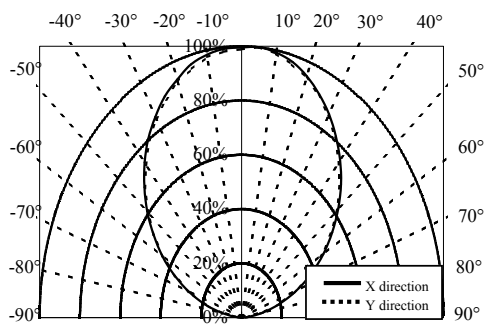

Symbol	CITLED
Name	CLL020-1204A1-403M1A2
CITIZEN ELECTRONICS CO.,LTD. JAPAN	

# DATA SHEET

6/11

## 6. Reliability

### (1) Details of the tests

Test Item	Test Condition
Continuous Operation Test	Ta=25 C, I <sub>F</sub> =240 mA× 1000 hours(with Al-fin)
	I <sub>Fmax</sub> =240 mA T <sub>jmax</sub> =150C× 1000 hours(with Al-fin)
Low Temperature Storage Test	-40 C × 1000 hours
High Temperature Storage Test	100 C × 1000 hours
Moisture-proof Test	85 C, 85 %RH for 500 hours
Thermal Shock Test	-40 C × 30 minutes – 100 C × 30 minutes, 100 cycle

### (2) Judgement Criteria of Failure for Reliability Test

(Ta=25C)

Measuring Item	Symbol	Measuring Condition	Judgement Criteria for Failure
Forward Voltage	VF	I <sub>F</sub> =240mA	>U X 1.1
Total Luminous Flux	Φ <sub>v</sub>	I <sub>F</sub> =240mA	<S X 0.85

U defines the upper limit of the specified characteristics. S defines the initial value.

Note : Measurement shall be taken between 2 hours and 24 hours, and the test pieces should be return to the normal ambient conditions after the completion of each test.

Symbol	CITILED
Name	CLL020-1204A1-403M1A2
CITIZEN ELECTRONICS CO.,LTD. JAPAN	

7. Packing Specifications

(1) Packing

An empty tray is placed on top of a six-tier tray which contain 54 pieces each. The set of seven trays is banded together with two rubber bands.

(Smallest packing unit: 324 pieces)

A label with product name, quantity, lot number is placed on the upper empty tray.

Tray (Dimensions: 310 × 210 × 12 mm / Materials: Electrically conductive PS)

< Packing figure >

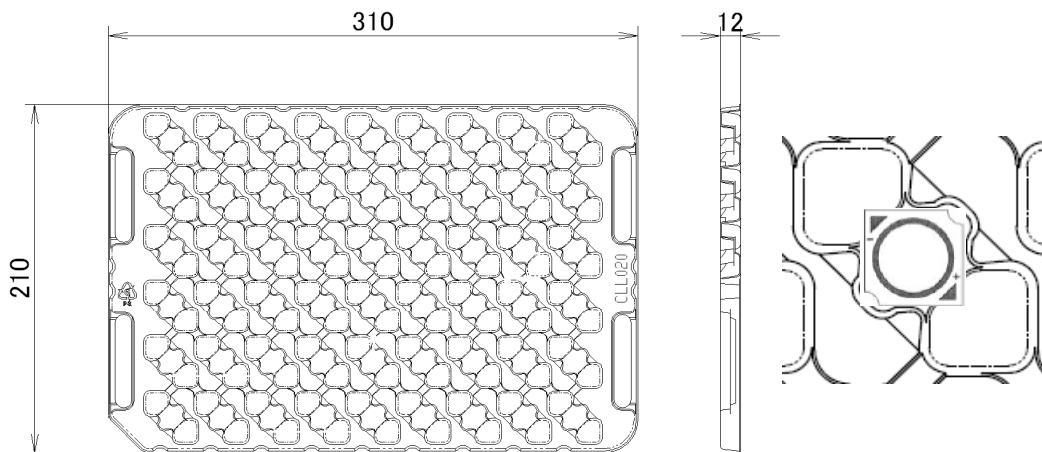

Product 54 pcs/tray

< Example of indication label >

CUSTOMER	
TYPE : CLL020-*****-*****-(1)	
P. NO : *****	---(2)
Lot No : *****	---(3)
Q'ty : ***	---(4)
CITIZEN ELECTRONICS	

- 1. TYPE e.g. CLL020-1204A1-403M1A2
- 2. P.No. (Cutomer's P/N) e.g. 50008-010-1203303M1
- 3. Lot No.
  - First and second letter: Last digit of the year e.g. 11 : year 2011
  - Third letter: Production month e.g. 8 : August
  - Note: October, November and December are designated
  - Forth letter: CE's control number e.g. 5035
- 4. Quantity

Symbol	CITILED
Name	CLL020-1204A1-403M1A2
CITIZEN ELECTRONICS CO.,LTD. JAPAN	

8. Precautions

(1) 1. Handling with care for this product

- Both the light emitting area and white dam over the light emitting area is composed of resin materials. Please avoid the resin area from being pressed, stressed, rubbed, come into contact with sharp metal nail (e.g. edge of reflector part) because the function, performance and reliability of this product are negatively impacted.
- Please be aware that this product should not come into contact with any other parts while incorporating in your lighting apparatus or your other products.

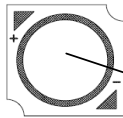

Resin portion (including white resin)

(2) Countermeasure against static electricity

- Handling of this product needs countermeasures against static electricity because this is a semiconductor product.
- Please take adequate measures to prevent any static electricity being produced such as the wearing of a wristband or anti-static gloves when handling this product.
- Every manufacturing facility in regard to the product (plant, equipment, machine, carrier machine and conveyance unit) should be connected to ground and please avoid the product to be electric-charged.
- ESD sensitivity of this product is over 1000V (HBM, based on JEITA ED-4701/304).
- After assembling the LEDs into your final product(s), it is recommended to check whether the assembled LEDs are damaged by static electricity (electrical leak phenomenon) or not.
- It is easy to find static damaged LED dies by a light-on test with the minimum current value.

(3) Caution of product assembly

- Regarding this product assembling on the heat sink, it is recommended to use M3 screw. It might be good for screw tightening on the heat sink to do temporary tightening and final tightening. In addition, please don't press with excess stress on the product.
- The condition of the product assembling on the heat sink and the control of screw tightening torque needs to be optimized according to the specification of the heat sink.
- Roughness, unevenness and burr of surface negatively impact thermal bonding between the product and heat sink and increase heat thermal resistance between them. Confidence of thermally and mechanical coupling between the product and heat sink are confirmed by checking the mounting surface and measuring the case temperature of the product.
- In order to reduce the thermal resistance at assembly, it might be good to use TIM (Thermal Interface Material) on whole contact surface of the product. In case of using thermal grease for the TIM, it might be good to be applied uniformly on the contact surface of the product. In case of using thermal sheet for the TIM, it might be good to make sure that the product is NOT strained by stress when the screws are tightened for assembly.

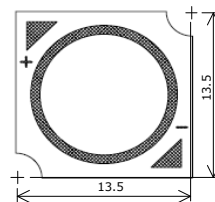
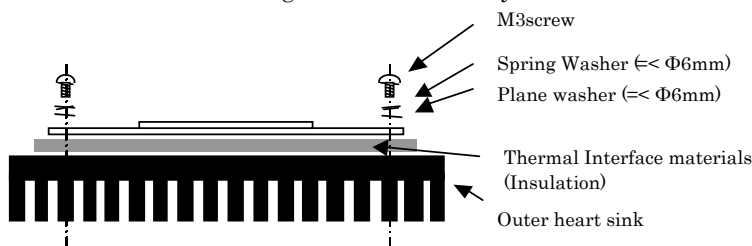

Recommended installation screw pitch

Symbol	CITLED
Name	CLL020-1204A1-403M1A2
CITIZEN ELECTRONICS CO.,LTD. JAPAN	

8. Precautions (continued)

(4) Thermal Design

-The thermal design to draw heat away from the LED junction is most critical parameter for an LED illumination system. High operating temperatures at the LED junction adversely affect the performance of LED's light output and lifetime. Therefore the LED junction temperature should not exceed the absolute maximum rating in LED illumination system.

(Note : Refer to 4-(1) Performance)

-The LED junction temperature while operation of LED illumination system depends upon thermal resistance of internal LED package (Rj-c), outer thermal resistances of LED package, power loss and ambient temperature. Please take both of the thermal design specifications and ambient temperature conditions into consideration for the setting of driving conditions.

-For more information, please refer to application note "Thermal Management CLL020 Series".

(5) Driving Current

-A constant current is recommended as an applying driving current to this product.

In the case of constant voltage driving, please connect current-limiting resistor to each products in series and control the driving current to keep under the absolute maximum rating forward current value.

-Electrical transient might apply excess voltage, excess current and reverse voltage to the product(s).

They also affect negative impact on the product(s) therefore please make sure that no excess voltage, excess current and reverse voltage is applied to the product(s) when the LED driver is turn-on and/or turn-off.

-For more information, please refer to application note "Driving".

(6) Lighting at a minimum current value

- The minimum current value of all LED dice lighting is 20 mA.

(The minimum current of each product is calculated and stated on the premise of 5mA dice)

-In a case where the lowest current is applied to the product, some of LED dice in the product might look different in their brightness due to the individual difference of the LED dice, and they are not failed.

(7) Electrical Safety

-This product is designed and produced according to IEC 62031:2008

(IEC 62031:2008 LED modules for general lighting. Safety specification)

-Dielectric voltage withstand test has been conducted on this product to see any failure after applying voltage between active pads and aluminum section of the product, and to pass at least 500V.

-Considering conformity assessment for IEC62031:2008, almost all items of the specification depend upon your final product of LED illumination system.

Therefore, please confirm with your final product for electrical safety of your product.

As well, the products comply with the criteria of IEC62031:2008 as single LED package.

Symbol	CITILED
Name	CLL020-1204A1-403M1A2
CITIZEN ELECTRONICS CO.,LTD. JAPAN	

8. Precautions (continued)

(8) Recommended soldering Condition (This product is not adaptable to reflow process.)

-For manual soldering

Please use lead-free soldering.

Soldering shall be implemented using a soldering bit at a temperature lower than 350C°, and shall be finished within 3.5 seconds for one land.

No external force shall be applied to resin part while soldering is implemented.

Next process of soldering should be carried out after the product has return to ambient temperature.

-For soldering correction

Regarding soldering correction, above conditions shall be applied.

Contacts number of soldering bit should be within twice for each terminal as a correction.

\* Citizen Electronics cannot guarantee if usage exceeds these recommended conditions.

Please use it after sufficient verification is carried out on your own risk if absolutely necessary.

(9) Eye Safety

-The International Electrical Commission (IEC) published in 2006 IEC 62471

"2006 Photobiological safety of lamps and lamp systems " which includes LEDs within its scope.

When sorting single LEDs according to IEC 62471, almost all white LEDs can be classified as belonging to either Exempt Group (no hazard) or Risk Group 1 (low risk).

-However, Optical characteristics of LEDs such as radiant flux,

spectrum and light distribution are factors that affect the risk group determination of the LED, and especially a high-power LED, that emits light containing blue wavelengths, might have properties equivalent to those of Risk Group 2 (moderate risk).

-Great care should be taken when directly viewing an LED that is driven at high current, has multiple uses as a module or when focusing the light with optical instruments, as these actions might greatly increase the hazard to your eyes.

-It is recommended to regard the evaluation of stand-alone LED packages as a reference ~~and to evaluate your final product.~~

(10) This product is not designed for usage under the following conditions.

If the product might be used under the following conditions, you shall evaluate its effect and appropriate them. In places where the product might:

-directly and indirectly get wet due to rain and/or at place with the fear.

-be damage by seawater and/or at place with the fear

-be exposed to corrosive gas (such as Cl2, H2S, NH3, SOx, NOx and so on) and/or at place with the fear.

-be exposed to dust, fluid or oil and/or at place with the fear.

Symbol	CITILED
Name	CLL020-1204A1-403M1A2
CITIZEN ELECTRONICS CO.,LTD. JAPAN	

**9. Precautions with regard to product use**

- (1) This document is provided for reference purposes only so that CITIZEN ELECTRONICS' products are used as intended. CITIZEN ELECTRONICS neither makes warranties or representations with respect to the accuracy or completeness of the information contained in this document nor grants any license to any intellectual property rights or any other rights of CITIZEN ELECTRONICS or any third party with respect to the information in this document.
  
- (2) All information included in this document such as product data, diagrams, charts, is current as of the date this document is issued.  
Such information, however, is subject to change without any prior notice.  
Before purchasing or using any CITIZEN ELECTRONICS' products listed in this document, please confirm the latest product information with a CITIZEN ELECTRONICS' sales office, and formal specifications must be exchanged and signed by both parties prior to mass production.
  
- (3) CITIZEN ELECTRONICS has used reasonable care in compiling the information included in this document, but CITIZEN ELECTRONICS assumes no liability whatsoever for any damages incurred as a result of errors or omissions in the information included in this document.
  
- (4) Absent a written signed agreement, except as provided in the relevant terms and conditions of sale for product, and to the maximum extent allowable by law, CITIZEN ELECTRONICS assumes no liability whatsoever, including without limitation, indirect, consequential, special, or incidental damages or loss, including without limitation, loss of profits, loss of opportunities, business interruption and loss of data, and disclaims any and all express or implied warranties and conditions related to sale, use of product, or information, including warranties or conditions of merchantability, fitness for a particular purpose, accuracy of information, or no infringement.
  
- (5) Though CITIZEN ELECTRONICS works continually to improve products' quality and reliability, products can malfunction or fail. Customers are responsible for complying with safety standards and for providing adequate designs and safeguards to minimize risk and avoid situations in which a malfunction or failure of a product could cause loss of human life, bodily injury or damage to property, including data loss or corruption.  
In addition, customers are also responsible for determining the appropriateness of use of any information contained in this document such as application cases not only with evaluating by their own but also by the entire system.  
CITIZEN ELECTRONICS assumes no liability for customers' product design or applications.
  
- (6) Please contact CITIZEN ELECTRONICS' sales office if you have any questions regarding the information contained in this document, or if you have any other inquiries.

CITIZEN Micro HumanTech is a registered trademark of Citizen Holding Co., Japan.  
CITILED is a registered trademark of CITIZEN ELECTRONICS CO., LTD. Japan

Symbol	CITILED
Name	CLL020-1204A1-403M1A2
CITIZEN ELECTRONICS CO.,LTD. JAPAN	