

5A Low Dropout Linear Regulator

Features

- Output current limiting
- Adjustable output voltage or fixed 1.5V, 1.8V, 2.5V, 3.3V, 5.0V
- Good noise rejection
- 1.4V maximum dropout at full load current
- Built-in thermal shutdown
- Fast transient response
- Packages: TO252, TO263

Applications

- PC peripheral
- Low Voltage Logic Supplies
- Post Regulator for Switching Power Supply

Description

EP1084 is a low dropout positive adjustable or fixed-mode regulator with minimum of 5.0A output current capability. The product is specifically designed to provide well-regulated supply for low voltage IC applications such as high-speed bus termination and low current 3.3V logic supply. EP1084 is also well suited for other applications such as VGA cards. EP1084 is guaranteed to have lower than 1.4V dropout at full load current making it ideal to provide well-regulated outputs of 1.25 to 3.3V with 4.7 to 12V input supply.

Typical Application

Fixed Mode Regulator

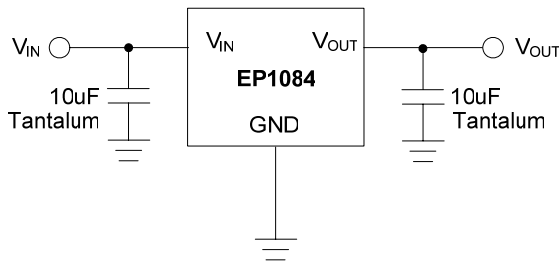

5.0V to 2.5V Adjustable Regulator

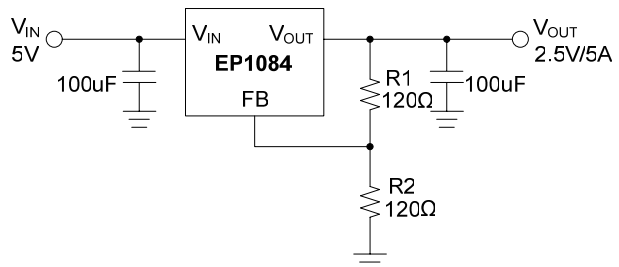

$$V_{OUT} = V_{REF} \times \left(1 + \frac{R2}{R1} \right)$$

$$V_{REF} = 1.25V$$

$$R1 \approx 100\Omega \sim 200\Omega$$

Pin Assignment

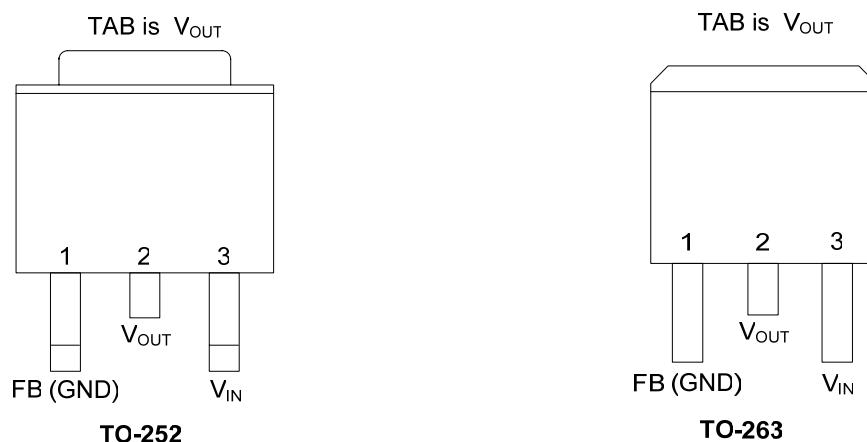

Ordering Information

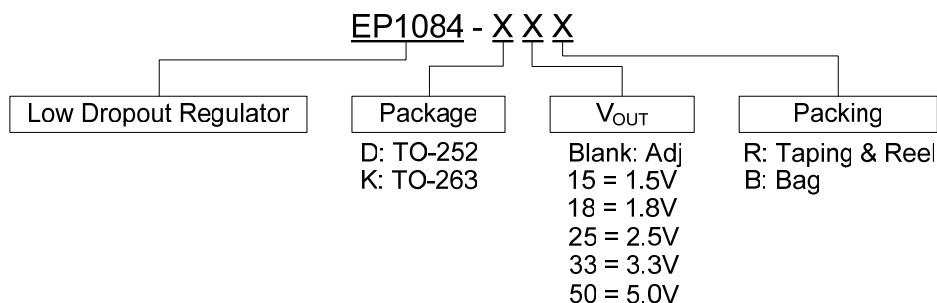

Pin Description

Pin	Name	Function
1	FB (GND)	Adjustable (Ground only for fixed mode) A resistor divider from this pin to the V _{OUT} pin and ground sets the output voltage. (Ground only for Fixed-Mode)
2	V _{OUT}	The output of the regulator. A minimum of 10uF (0.15Ω ≤ ESR ≤ 20Ω) capacitor must be connected from this pin to ground to insure stability.
3	V _{IN}	The input pin of regulator. Typically a large storage capacitor (0.15Ω ≤ ESR ≤ 20Ω) is connected from this pin to ground to insure that the input voltage does not sag below the minimum dropout voltage during the load transient response. This pin must always be 1.4V (1.3V) higher than V _{OUT} in order for the device to regulate properly.

Absolute Maximum Rating

Symbol	Item	Rating (Note 2)	Units
V _I	DC Supply Voltage	15	V
P _D	Power Dissipation	Internally Limited	
T _{STG}	Storage Temperature Range	-65 ~ +150	°C
T _{OP}	Operating Junction Temperature Range	0 ~ +150	°C

Electrical Characteristics

(Under operating conditions)

Symbol	Parameter		Conditions	Min.	Typ.	Max.	Units
V _{REF}	Reference Voltage		T _J =25°C, I _{OUT} =10mA, (V _{IN} -V _{OUT})=1.5V	1.225	1.250	1.275	V
REG _{LINE}	Line Regulation	EP1084-adj	T _J =25°C, I _{OUT} =10mA, V _{OUT} +1.5V<V _{IN} <12V			0.2	%
		EP1084-15	T _J =25°C, I _{OUT} =10mA, 3V≤V _{IN} ≤12V	1.470	1.500	1.530	V
		EP1084-18	T _J =25°C, I _{OUT} =10mA, 3.3V≤V _{IN} ≤12V	1.764	1.800	1.836	
		EP1084-25	T _J =25°C, I _{OUT} =10mA, 4V≤V _{IN} ≤12V	2.450	2.500	2.550	
		EP1084-33	T _J =25°C, I _{OUT} =10mA, 4.8V≤V _{IN} ≤12V	3.235	3.300	3.365	
		EP1084-50	T _J =25°C, I _{OUT} =10mA, 6.5V≤V _{IN} ≤12V	4.900	5.000	5.100	
REG _{LOAD}	Load Regulation	EP1084-adj	T _J =25°C, V _{IN} =3.3V, 0mA<I _{OUT} <5A (Note 1, 2)			1	%
		EP1084-15	T _J =25°C, V _{IN} =3V, 0mA<I _{OUT} <5A (Note 1, 2)		12	15	mV
		EP1084-18	T _J =25°C, V _{IN} =3.3V, 0mA<I _{OUT} <5A (Note 1, 2)		15	18	
		EP1084-25	T _J =25°C, V _{IN} =4V, 0mA<I _{OUT} <5A (Note 1, 2)		20	25	
		EP1084-33	T _J =25°C, V _{IN} =5V, 0mA<I _{OUT} <5A (Note 1, 2)		26	33	
		EP1084-50	T _J =25°C, V _{IN} =8V, 0mA<I _{OUT} <5A (Note 1, 2)		45	50	
V _D	Dropout Voltage		I _{OUT} =5A(ΔV _{OUT} =1%V _{OUT})		1.3	1.4	V
I _{LIMIT}	Current Limit		(V _{IN} -V _{OUT})=5V	5.1			A
I _O	Minimum Load Current				5	10	mA
T _S	Temperature Stability		I _{OUT} =10mA		0.5		%
θ _{JA}	Thermal Resistance	TO-252	Junction-to-Ambient (No heat sink ;No air flow)		98		°C/W
		TO-263			83		
θ _{JC}	Thermal Resistance	TO-252	Junction-to-Case (Control circuitry/Power transistor)		10		°C/W
		TO-263			0.65/2.7		

Note 1: See thermal regulation specifications for changes in output voltage due to heating effects. Line and load regulation are measured at a constant junction temperature by low duty cycle pulse testing. Load regulation is measured at the output lead = 1/18" from the package.

Note 2: Line and load regulation are guaranteed up to the maximum power dissipation of 15W. Power dissipation is determined by the difference between input and output and the output current. Guaranteed maximum power dissipation will not be available over the full input/output range.

Typical Performance Characteristics

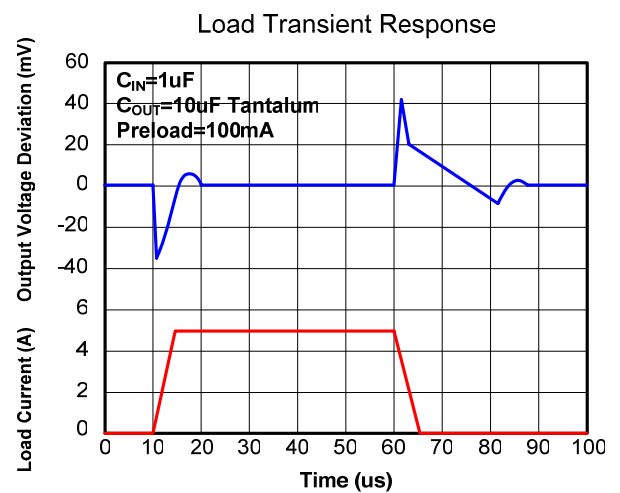
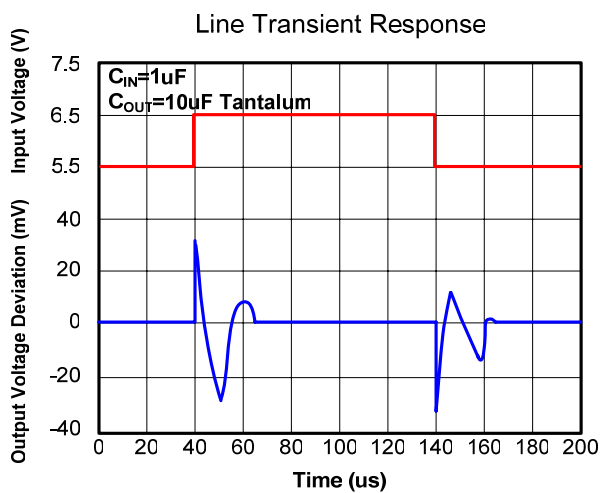
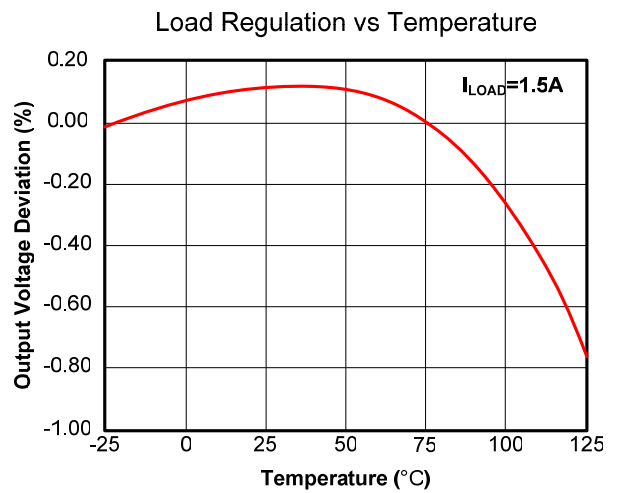
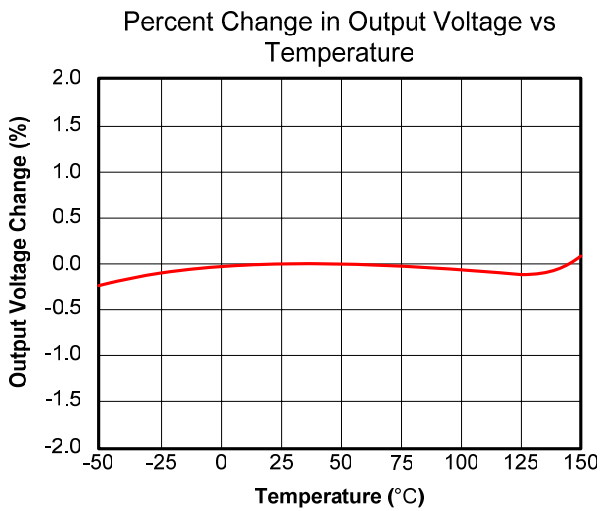
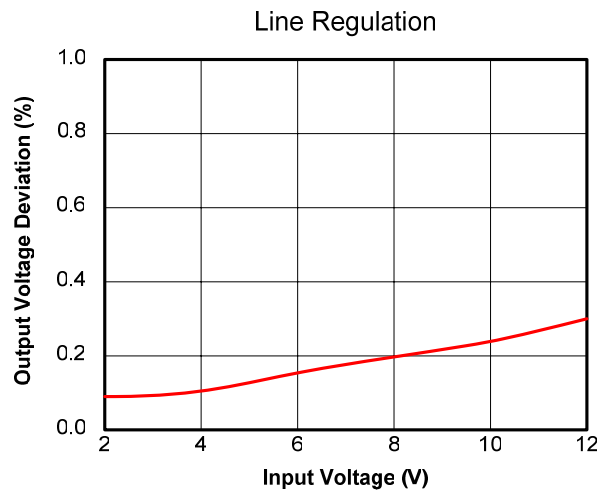
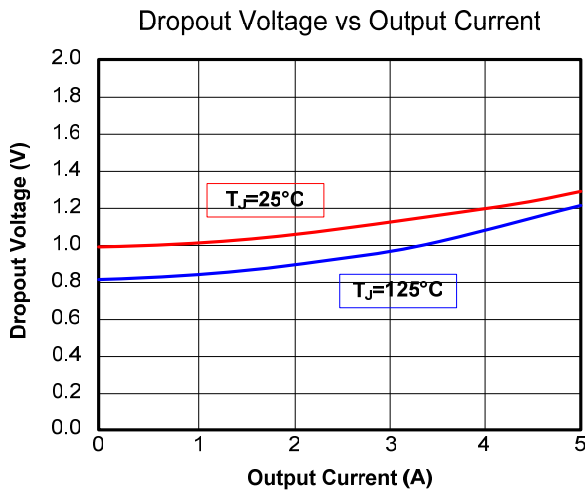

Functional Block Diagram

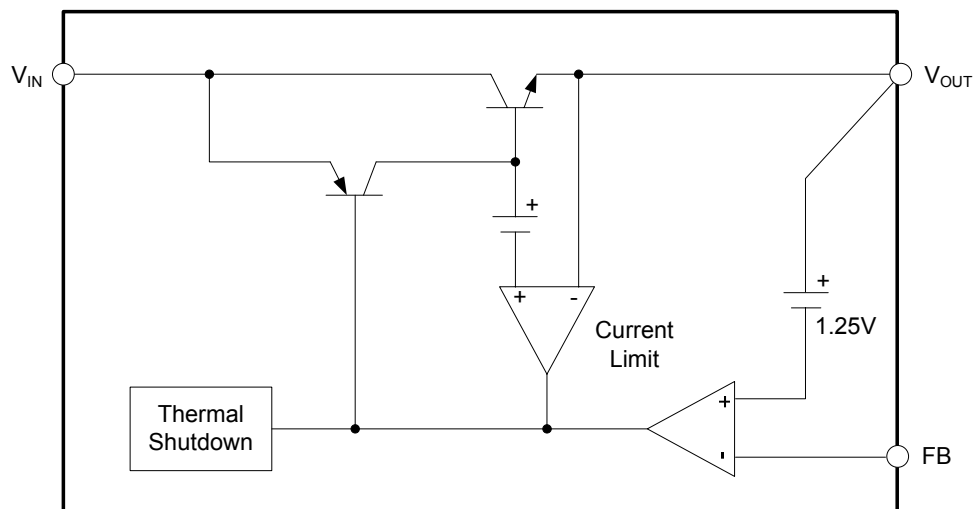

Introduction

The EP1084 adjustable Low Dropout (LDO) regulator is a 3 terminal device that can easily be programmed with the addition of two external resistors to any voltages within the range of 1.25V to $V_{IN} - 1.4V$. The EP1084 only needs 1.4V differential between V_{IN} and V_{OUT} to maintain output regulation. In addition, the output voltage tolerances are also extremely tight and they include the transient response as part of the specification. For example, Intel VRE specification calls for a total of $\pm 100mV$ including initial tolerance, load regulation and 0 to 5.0A load step.

The EP1084 is specifically designed to meet the fast current transient needs as well as providing an accurate initial voltage, reducing the overall system cost with the need for fewer output capacitors.

Output Voltage Setting

The EP1084 can be programmed to any voltages in the range of 1.25V to $V_{IN} - 1.4V$ with the addition of R1 and R2 external resistors according to the following formula:

The EP1084 keeps a constant 1.25V between the output pin and the FB pin. By placing a resistor R1 across these two pins a constant current flows through R1, adding to the I_{FB} current and into the R2 resistor producing a voltage equal to the $(1.25/R1) \cdot R2 + I_{FB} \cdot R2$ which will be added to the 1.25V to set the output voltage. This is summarized in the above equation. Since the minimum load current requirement of the EP1084 is 10mA, R1 is typically selected to be 121 Ω resistor so that it automatically satisfies the minimum current requirement. Notice that since I_{FB} is typically in the range of 55uA it only adds a small error to the output voltage and should only be considered when a very precise output voltage setting is required. For example, in a typical 3.3V application where R1=121 Ω and R2=200 Ω the error due to I_{FB} is only 0.3% of the nominal set point.

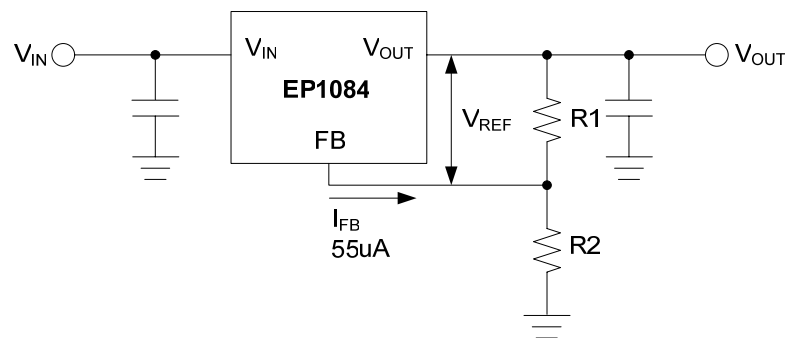

$$V_{OUT} = V_{REF} \times \left(1 + \frac{R2}{R1} \right) + I_{FB}R2$$

Load Regulation

Since the EP1084 is only a 3 terminal device, it is not possible to provide true remote sensing of the output voltage at the load. The best load regulation is achieved when the bottom side of R2 is connected to the load and the top-side of R1 resistor is connected directly to the case or the V_{OUT} pin of the regulator and not to the load. It is important to note that for high current applications, this can re-present a significant percentage of the overall load regulation and one must keep the path from the regulator to the load as short as possible to minimize this effect.

Stability

The EP1084 requires the use of an output capacitor as part of the frequency compensation in order to make the regulator stable. For most applications a minimum of 10uF aluminum electrolytic capacitor insures both stability and good transient response.

Thermal Design

The EP1084 incorporates an internal thermal shutdown that protects the device when the junction temperature exceeds the maximum allowable junction temperature. Although this device can operate with junction temperatures in the range of 150°C, it is recommended that the selected heat sink be chosen such that during maximum continuous load operation the junction temperature is kept below the temperature.

Layout Consideration

The output capacitors must be located as close to the V_{OUT} terminal of the device as possible. It is recommended to use a section of a layer of the PC board as a plane to connect the V_{OUT} pin to the output capacitors to prevent any high frequency oscillation that may result due to excessive trace inductance.

Package Description

TO-252

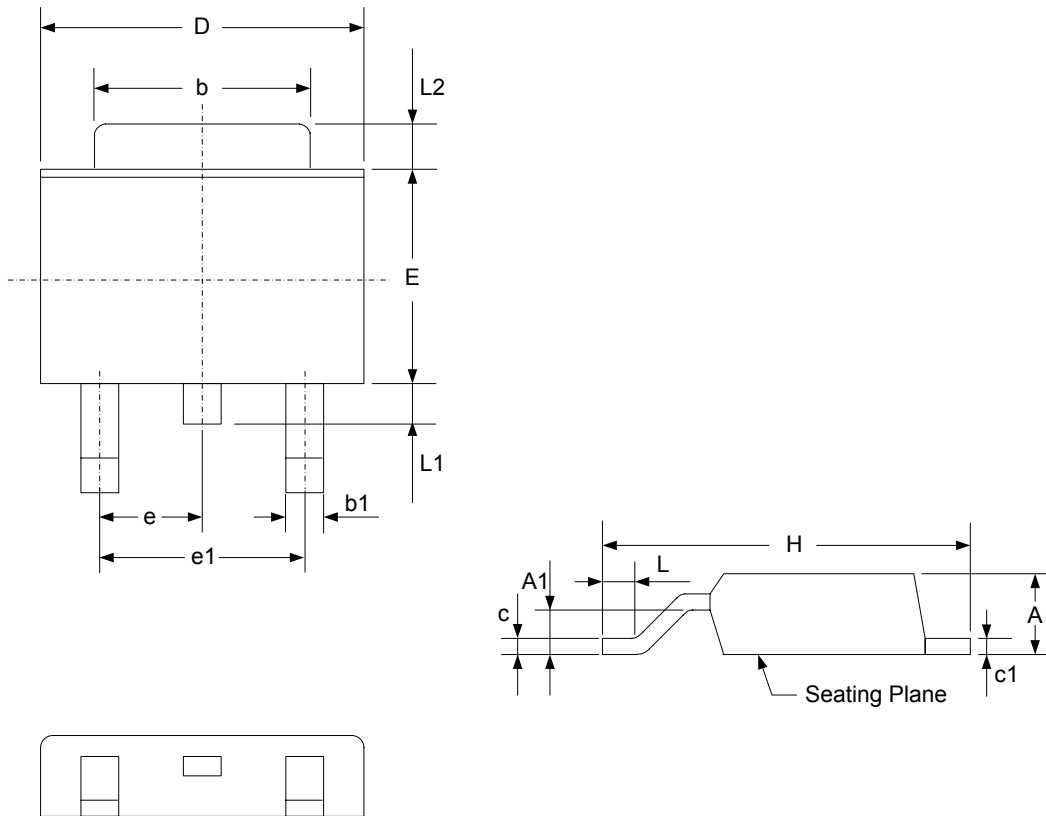

DIM	MILLIMETERS			INCHES		
	MIN.	NOM.	MAX.	MIN.	NOM.	MAX.
A	2.18	2.29	2.40	0.086	0.090	0.094
A1	0.89	-	1.14	0.035	-	0.045
b	5.20	5.35	5.50	0.205	0.211	0.217
b1	0.61 TYP.			0.024 TYP.		
c	0.45	0.52	0.58	0.018	0.020	0.023
c1	0.45	0.52	0.58	0.018	0.020	0.023
D	6.35	6.58	6.80	0.250	0.259	0.268
E	5.40	5.57	6.20	0.213	0.219	0.244
e	2.28 REF.			0.090 REF.		
e1	4.57 REF.			0.180 REF.		
H	9.00	9.70	10.40	0.354	0.382	0.409
L	0.51	-	-	0.020	-	-
L1	0.64	0.83	1.02	0.025	0.033	0.040
L2	0.88	-	1.27	0.035	-	0.050

Package Description (Continued)

TO-263

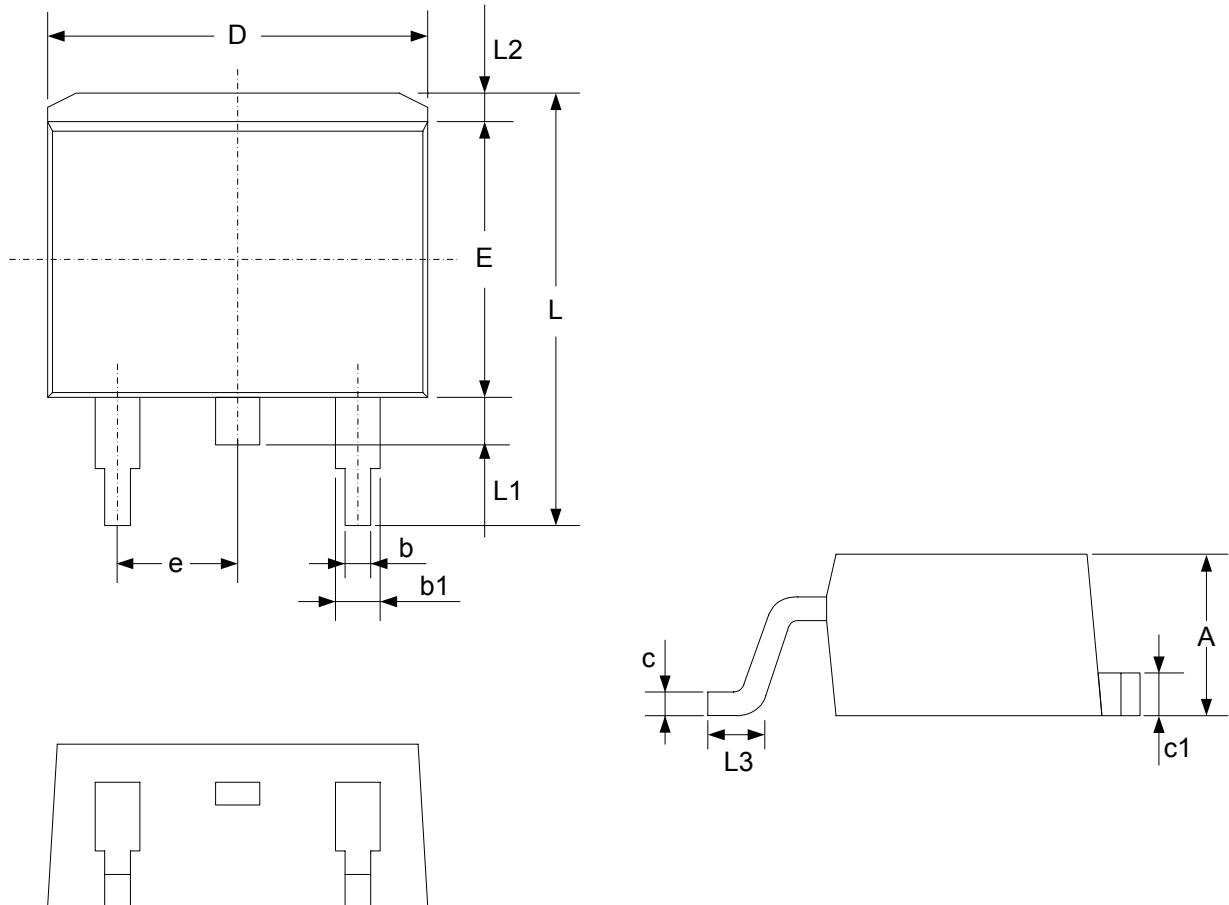

DIM	MILLIMETERS			INCHES		
	MIN.	NOM.	MAX.	MIN.	NOM.	MAX.
A	4.06	4.45	4.83	0.160	0.175	0.190
b	0.51	0.75	0.99	0.020	0.030	0.039
b1	1.14	1.27	1.40	0.045	0.050	0.055
c	0.38 TYP.			0.015 TYP.		
c1	1.14	1.27	1.40	0.045	0.050	0.055
D	9.65	9.97	10.29	0.380	0.393	0.405
E	8.65	9.15	9.65	0.341	0.360	0.380
e	2.54 BSC.			0.100 BSC.		
L	14.61	15.24	15.88	0.575	0.600	0.625
L1	1.27	1.52	1.78	0.050	0.060	0.070
L2	-	1.30	2.92	-	0.051	0.115
L3	2.28	2.54	2.80	0.090	0.100	0.110