

# 1GB Registered DDR2 SDRAM DIMM

## EBE10RD4AEFA-6 (128M words × 72 bits, 1 Rank)

### Description

The EBE10RD4AEFA is a 128M words × 72 bits, 1 rank DDR2 SDRAM Module, mounting 18 pieces of DDR2 SDRAM sealed in FBGA package. Read and write operations are performed at the cross points of the CK and the /CK. This high-speed data transfer is realized by the 4bits prefetch-pipelined architecture. Data strobe (DQS and /DQS) both for read and write are available for high speed and reliable data bus design. By setting extended mode register, the on-chip Delay Locked Loop (DLL) can be set enable or disable. This module provides high density mounting without utilizing surface mount technology. Decoupling capacitors are mounted beside each FBGA on the module board.

Note: Do not push the components or drop the modules in order to avoid mechanical defects, which may result in electrical defects.

### Features

- 240-pin socket type dual in line memory module (DIMM)
  - PCB height: 30.0mm
  - Lead pitch: 1.0mm
  - Lead-free (RoHS compliant)
- Power supply: VDD = 1.8V ± 0.1V
- Data rate: 667Mbps (max.)
- SSTL\_18 compatible I/O
- Double-data-rate architecture: two data transfers per clock cycle
- Bi-directional, data strobe (DQS and /DQS) is transmitted /received with data, to be used in capturing data at the receiver
- DQS is edge aligned with data for READs; center aligned with data for WRITEs
- Differential clock inputs (CK and /CK)
- DLL aligns DQ and DQS transitions with CK transitions
- Commands entered on each positive CK edge; data referenced to both edges of DQS
- Four internal banks for concurrent operation (components)
- Burst length: 4, 8
- /CAS latency (CL): 3, 4, 5
- Auto precharge option for each burst access
- Auto refresh and self refresh modes
- Average refresh period
  - 7.8μs at 0°C ≤ TC ≤ +85°C
  - 3.9μs at +85°C < TC ≤ +95°C
- Posted CAS by programmable additive latency for better command and data bus efficiency
- Off-Chip-Driver Impedance Adjustment and On-Die-Termination for better signal quality
- /DQS can be disabled for single-ended Data Strobe operation
- 1 piece of PLL clock driver, 2 pieces of register driver and 1 piece of serial EEPROM (2k bits EEPROM) for Presence Detect (PD)

**Ordering Information**

| Part number       | Data rate<br>Mbps (max.) | Component<br>JEDEC speed bin* <sup>1</sup><br>(CL-tRCD-tRP) | Package                     | Contact<br>pad | Mounted devices  |
|-------------------|--------------------------|---|-----------------------------|----------------|------------------|
| EBE10RD4AEFA-6E-E | 667                      | DDR2-667 (5-5-5)  | 240-pin DIMM<br>(lead-free) | Gold           | EDE5104AESK-6E-E |

Note: 1. Module /CAS latency = component CL + 1

**Pin Configurations**

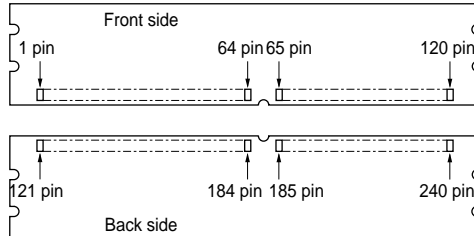

| Pin No. | Pin name | Pin No. | Pin name  | Pin No. | Pin name | Pin No. | Pin name |
|---------|----------|---------|-----------|---------|----------|---------|----------|
| 1       | VREF     | 61      | A4        | 121     | VSS      | 181     | VDD      |
| 2       | VSS      | 62      | VDD       | 122     | DQ4      | 182     | A3       |
| 3       | DQ0      | 63      | A2        | 123     | DQ5      | 183     | A1       |
| 4       | DQ1      | 64      | VDD       | 124     | VSS      | 184     | VDD      |
| 5       | VSS      | 65      | VSS       | 125     | DQS9     | 185     | CK0      |
| 6       | /DQS0    | 66      | VSS       | 126     | /DQS9    | 186     | /CK0     |
| 7       | DQS0     | 67      | VDD       | 127     | VSS      | 187     | VDD      |
| 8       | VSS      | 68      | NC/Par_In | 128     | DQ6      | 188     | A0       |
| 9       | DQ2      | 69      | VDD       | 129     | DQ7      | 189     | VDD      |
| 10      | DQ3      | 70      | A10       | 130     | VSS      | 190     | BA1      |
| 11      | VSS      | 71      | BA0       | 131     | DQ12     | 191     | VDD      |
| 12      | DQ8      | 72      | VDD       | 132     | DQ13     | 192     | /RAS     |
| 13      | DQ9      | 73      | /WE       | 133     | VSS      | 193     | /CS0     |
| 14      | VSS      | 74      | /CAS      | 134     | DQS10    | 194     | VDD      |
| 15      | /DQS1    | 75      | VDD       | 135     | /DQS10   | 195     | ODT0     |
| 16      | DQS1     | 76      | NC        | 136     | VSS      | 196     | A13      |
| 17      | VSS      | 77      | NC        | 137     | NC       | 197     | VDD      |
| 18      | /RESET   | 78      | VDD       | 138     | NC       | 198     | VSS      |
| 19      | NC       | 79      | VSS       | 139     | VSS      | 199     | DQ36     |
| 20      | VSS      | 80      | DQ32      | 140     | DQ14     | 200     | DQ37     |
| 21      | DQ10     | 81      | DQ33      | 141     | DQ15     | 201     | VSS      |
| 22      | DQ11     | 82      | VSS       | 142     | VSS      | 202     | DQS13    |
| 23      | VSS      | 83      | /DQS4     | 143     | DQ20     | 203     | /DQS13   |
| 24      | DQ16     | 84      | DQS4      | 144     | DQ21     | 204     | VSS      |
| 25      | DQ17     | 85      | VSS       | 145     | VSS      | 205     | DQ38     |
| 26      | VSS      | 86      | DQ34      | 146     | DQS11    | 206     | DQ39     |
| 27      | /DQS2    | 87      | DQ35      | 147     | /DQS11   | 207     | VSS      |
| 28      | DQS2     | 88      | VSS       | 148     | VSS      | 208     | DQ44     |
| 29      | VSS      | 89      | DQ40      | 149     | DQ22     | 209     | DQ45     |

| Pin No. | Pin name   | Pin No. | Pin name | Pin No. | Pin name | Pin No. | Pin name |
|---------|------------|---------|----------|---------|----------|---------|----------|
| 30      | DQ18       | 90      | DQ41     | 150     | DQ23     | 210     | VSS      |
| 31      | DQ19       | 91      | VSS      | 151     | VSS      | 211     | DQS14    |
| 32      | VSS        | 92      | /DQS5    | 152     | DQ28     | 212     | /DQS14   |
| 33      | DQ24       | 93      | DQS5     | 153     | DQ29     | 213     | VSS      |
| 34      | DQ25       | 94      | VSS      | 154     | VSS      | 214     | DQ46     |
| 35      | VSS        | 95      | DQ42     | 155     | DQS12    | 215     | DQ47     |
| 36      | /DQS3      | 96      | DQ43     | 156     | /DQS12   | 216     | VSS      |
| 37      | DQS3       | 97      | VSS      | 157     | VSS      | 217     | DQ52     |
| 38      | VSS        | 98      | DQ48     | 158     | DQ30     | 218     | DQ53     |
| 39      | DQ26       | 99      | DQ49     | 159     | DQ31     | 219     | VSS      |
| 40      | DQ27       | 100     | VSS      | 160     | VSS      | 220     | NC       |
| 41      | VSS        | 101     | SA2      | 161     | CB4      | 221     | NC       |
| 42      | CB0        | 102     | NC       | 162     | CB5      | 222     | VSS      |
| 43      | CB1        | 103     | VSS      | 163     | VSS      | 223     | DQS15    |
| 44      | VSS        | 104     | /DQS6    | 164     | DQS17    | 224     | /DQS15   |
| 45      | /DQS8      | 105     | DQS6     | 165     | /DQS17   | 225     | VSS      |
| 46      | DQS8       | 106     | VSS      | 166     | VSS      | 226     | DQ54     |
| 47      | VSS        | 107     | DQ50     | 167     | CB6      | 227     | DQ55     |
| 48      | CB2        | 108     | DQ51     | 168     | CB7      | 228     | VSS      |
| 49      | CB3        | 109     | VSS      | 169     | VSS      | 229     | DQ60     |
| 50      | VSS        | 110     | DQ56     | 170     | VDD      | 230     | DQ61     |
| 51      | VDD        | 111     | DQ57     | 171     | NC       | 231     | VSS      |
| 52      | CKE0       | 112     | VSS      | 172     | VDD      | 232     | DQS16    |
| 53      | VDD        | 113     | /DQS7    | 173     | NC       | 233     | /DQS16   |
| 54      | NC         | 114     | DQS7     | 174     | NC       | 234     | VSS      |
| 55      | NC/Err_Out | 115     | VSS      | 175     | VDD      | 235     | DQ62     |
| 56      | VDD        | 116     | DQ58     | 176     | A12      | 236     | DQ63     |
| 57      | A11        | 117     | DQ59     | 177     | A9       | 237     | VSS      |
| 58      | A7         | 118     | VSS      | 178     | VDD      | 238     | VDDSPD   |
| 59      | VDD        | 119     | SDA      | 179     | A8       | 239     | SA0      |
| 60      | A5         | 120     | SCL      | 180     | A6       | 240     | SA1      |

**Pin Description**

| Pin name                       | Function   |
|--------------------------------|--|
| A0 to A13                      | Address input<br>Row address A0 to A13<br>Column address A0 to A9, A11 |
| A10 (AP)                       | Auto precharge   |
| BA0, BA1                       | Bank select address  |
| DQ0 to DQ63                    | Data input/output  |
| CB0 to CB7                     | Check bit (Data input/output)  |
| /RAS                           | Row address strobe command   |
| /CAS                           | Column address strobe command  |
| /WE                            | Write enable   |
| /CS0                           | Chip select  |
| CKE0                           | Clock enable   |
| CK0                            | Clock input  |
| /CK0                           | Differential clock input   |
| DQS0 to DQS17, /DQS0 to /DQS17 | Input and output data strobe   |
| SCL                            | Clock input for serial PD  |
| SDA                            | Data input/output for serial PD  |
| SA0 to SA2                     | Serial address input   |
| VDD                            | Power for internal circuit   |
| VDDSPD                         | Power for serial EEPROM  |
| VREF                           | Input reference voltage  |
| VSS                            | Ground   |
| ODT0                           | ODT control  |
| /RESET                         | Reset pin (forces register and PLL inputs low) <sup>*1</sup>           |
| Par_In <sup>*2</sup>           | Parity bit for the address and control bus                             |
| Err_Out <sup>*2</sup>          | Parity error found on the address and control bus                      |
| NC                             | No connection  |

Note: 1. Reset pin is connected to both OE of PLL and reset to register.

2. NC/Err\_Out (Pin No. 55) and NC/Par\_In (Pin No. 68) are for optional function to check address and command parity.

**Serial PD Matrix\*<sup>1</sup>**

| Byte No. | Function described                                       | Bit7 | Bit6 | Bit5 | Bit4 | Bit3 | Bit2 | Bit1 | Bit0 | Hex value | Comments                    |
|----------|--|------|------|------|------|------|------|------|------|-----------|-----------------------------|
| 0        | Number of bytes utilized by module manufacturer          | 1    | 0    | 0    | 0    | 0    | 0    | 0    | 0    | 80H       | 128 bytes                   |
| 1        | Total number of bytes in serial PD device                | 0    | 0    | 0    | 0    | 1    | 0    | 0    | 0    | 08H       | 256 bytes                   |
| 2        | Memory type  | 0    | 0    | 0    | 0    | 1    | 0    | 0    | 0    | 08H       | DDR2 SDRAM                  |
| 3        | Number of row address                                    | 0    | 0    | 0    | 0    | 1    | 1    | 1    | 0    | 0EH       | 14                          |
| 4        | Number of column address                                 | 0    | 0    | 0    | 0    | 1    | 0    | 1    | 1    | 0BH       | 11                          |
| 5        | Number of DIMM ranks                                     | 0    | 1    | 1    | 0    | 0    | 0    | 0    | 0    | 60H       | 1                           |
| 6        | Module data width  | 0    | 1    | 0    | 0    | 1    | 0    | 0    | 0    | 48H       | 72                          |
| 7        | Module data width continuation                           | 0    | 0    | 0    | 0    | 0    | 0    | 0    | 0    | 00H       | 0                           |
| 8        | Voltage interface level of this assembly                 | 0    | 0    | 0    | 0    | 0    | 1    | 0    | 1    | 05H       | SSTL 1.8V                   |
| 9        | DDR SDRAM cycle time, CL = 5                             | 0    | 0    | 1    | 1    | 0    | 0    | 0    | 0    | 30H       | 3.0ns* <sup>1</sup>         |
| 10       | SDRAM access from clock (tAC)                            | 0    | 1    | 0    | 0    | 0    | 1    | 0    | 1    | 45H       | 0.45ns* <sup>1</sup>        |
| 11       | DIMM configuration type                                  | 0    | 0    | 0    | 0    | 0    | 0    | 1    | 0    | 02H       | ECC                         |
| 12       | Refresh rate/type  | 1    | 0    | 0    | 0    | 0    | 0    | 1    | 0    | 82H       | 7.8μs                       |
| 13       | Primary SDRAM width                                      | 0    | 0    | 0    | 0    | 0    | 1    | 0    | 0    | 04H       | × 4                         |
| 14       | Error checking SDRAM width                               | 0    | 0    | 0    | 0    | 0    | 1    | 0    | 0    | 04H       | × 4                         |
| 15       | Reserved   | 0    | 0    | 0    | 0    | 0    | 0    | 0    | 0    | 00H       | 0                           |
| 16       | SDRAM device attributes: Burst length supported          | 0    | 0    | 0    | 0    | 1    | 1    | 0    | 0    | 0CH       | 4,8                         |
| 17       | SDRAM device attributes: Number of banks on SDRAM device | 0    | 0    | 0    | 0    | 0    | 1    | 0    | 0    | 04H       | 4                           |
| 18       | SDRAM device attributes: /CAS latency                    | 0    | 0    | 1    | 1    | 1    | 0    | 0    | 0    | 38H       | 3, 4, 5                     |
| 19       | DIMM Mechanical Characteristics                          | 0    | 0    | 0    | 0    | 0    | 0    | 0    | 1    | 01H       | 4.00mm max.                 |
| 20       | DIMM type information                                    | 0    | 0    | 0    | 0    | 0    | 0    | 0    | 1    | 01H       | Registered                  |
| 21       | SDRAM module attributes                                  | 0    | 0    | 0    | 0    | 0    | 0    | 0    | 0    | 00H       | Normal                      |
| 22       | SDRAM device attributes: General                         | 0    | 0    | 0    | 0    | 0    | 0    | 1    | 1    | 03H       | Weak Driver 50Ω ODT Support |
| 23       | Minimum clock cycle time at CL = 4                       | 0    | 0    | 1    | 1    | 1    | 1    | 0    | 1    | 3DH       | 3.75ns* <sup>1</sup>        |
| 24       | Maximum data access time (tAC) from clock at CL = 4      | 0    | 1    | 0    | 1    | 0    | 0    | 0    | 0    | 50H       | 0.5ns* <sup>1</sup>         |
| 25       | Minimum clock cycle time at CL = 3                       | 0    | 1    | 0    | 1    | 0    | 0    | 0    | 0    | 50H       | 5.0ns* <sup>1</sup>         |
| 26       | Maximum data access time (tAC) from clock at CL = 3      | 0    | 1    | 1    | 0    | 0    | 0    | 0    | 0    | 60H       | 0.6ns* <sup>1</sup>         |
| 27       | Minimum row precharge time (tRP)                         | 0    | 0    | 1    | 1    | 1    | 1    | 0    | 0    | 3CH       | 15ns                        |
| 28       | Minimum row active to row active delay (tRRD)            | 0    | 0    | 0    | 1    | 1    | 1    | 1    | 0    | 1EH       | 7.5ns                       |
| 29       | Minimum /RAS to /CAS delay (tRCD)                        | 0    | 0    | 1    | 1    | 1    | 1    | 0    | 0    | 3CH       | 15ns                        |
| 30       | Minimum active to precharge time (tRAS)                  | 0    | 0    | 1    | 0    | 1    | 1    | 0    | 1    | 2DH       | 45ns                        |
| 31       | Module rank density                                      | 0    | 0    | 0    | 0    | 0    | 0    | 0    | 1    | 01H       | 1GB                         |
| 32       | Address and command setup time before clock (tIS)        | 0    | 0    | 1    | 0    | 0    | 0    | 0    | 0    | 20H       | 0.20ns* <sup>1</sup>        |
| 33       | Address and command hold time after clock (tIH)          | 0    | 0    | 1    | 0    | 1    | 0    | 0    | 0    | 28H       | 0.28ns* <sup>1</sup>        |
| 34       | Data input setup time before clock (tDS)                 | 0    | 0    | 0    | 1    | 0    | 0    | 0    | 0    | 10H       | 0.10ns* <sup>1</sup>        |

| Byte No. | Function described   | Bit7 | Bit6 | Bit5 | Bit4 | Bit3 | Bit2 | Bit1 | Bit0 | Hex value | Comments          |
|----------|--|------|------|------|------|------|------|------|------|-----------|-------------------|
| 35       | Data input hold time after clock (tDH)                       | 0    | 0    | 0    | 1    | 1    | 0    | 0    | 0    | 18H       | 0.18ns*1          |
| 36       | Write recovery time (tWR)                                    | 0    | 0    | 1    | 1    | 1    | 1    | 0    | 0    | 3CH       | 15ns*1            |
| 37       | Internal write to read command delay (tWTR)                  | 0    | 0    | 0    | 1    | 1    | 1    | 1    | 0    | 1EH       | 7.5ns*1           |
| 38       | Internal read to precharge command delay (tRTP)              | 0    | 0    | 0    | 1    | 1    | 1    | 1    | 0    | 1EH       | 7.5ns*1           |
| 39       | Memory analysis probe characteristics                        | 0    | 0    | 0    | 0    | 0    | 0    | 0    | 0    | 00H       | TBD               |
| 40       | Extension of Byte 41 and 42                                  | 0    | 0    | 0    | 0    | 0    | 0    | 0    | 0    | 00H       | Undefined         |
| 41       | Active command period (tRC)                                  | 0    | 0    | 1    | 1    | 1    | 1    | 0    | 0    | 3CH       | 60ns*1            |
| 42       | Auto refresh to active/<br>Auto refresh command cycle (tRFC) | 0    | 1    | 1    | 0    | 1    | 0    | 0    | 1    | 69H       | 105ns*1           |
| 43       | SDRAM tCK cycle max. (tCK max.)                              | 1    | 0    | 0    | 0    | 0    | 0    | 0    | 0    | 80H       | 8ns*1             |
| 44       | Dout to DQS skew   | 0    | 0    | 0    | 1    | 1    | 0    | 0    | 0    | 18H       | 0.24ns*1          |
| 45       | Data hold skew (tQHS)  | 0    | 0    | 1    | 0    | 0    | 0    | 1    | 0    | 22H       | 0.34ns*1          |
| 46       | PLL relock time  | 0    | 0    | 0    | 0    | 1    | 1    | 1    | 1    | 0FH       | 15µs              |
| 47 to 61 |  | 0    | 0    | 0    | 0    | 0    | 0    | 0    | 0    | 00H       |                   |
| 62       | SPD Revision   | 0    | 0    | 0    | 1    | 0    | 0    | 1    | 0    | 12H       | Rev. 1.2          |
| 63       | Checksum for bytes 0 to 62                                   | 0    | 0    | 0    | 0    | 1    | 1    | 0    | 1    | 0DH       |                   |
| 64 to 65 | Manufacturer's JEDEC ID code                                 | 0    | 1    | 1    | 1    | 1    | 1    | 1    | 1    | 7FH       | Continuation code |
| 66       | Manufacturer's JEDEC ID code                                 | 1    | 1    | 1    | 1    | 1    | 1    | 1    | 0    | FEH       | Elpida Memory     |
| 67 to 71 | Manufacturer's JEDEC ID code                                 | 0    | 0    | 0    | 0    | 0    | 0    | 0    | 0    | 00H       |                   |
| 72       | Manufacturing location                                       | ×    | ×    | ×    | ×    | ×    | ×    | ×    | ×    | ×         | (ASCII-8bit code) |
| 73       | Module part number   | 0    | 1    | 0    | 0    | 0    | 1    | 0    | 1    | 45H       | E                 |
| 74       | Module part number   | 0    | 1    | 0    | 0    | 0    | 0    | 1    | 0    | 42H       | B                 |
| 75       | Module part number   | 0    | 1    | 0    | 0    | 0    | 1    | 0    | 1    | 45H       | E                 |
| 76       | Module part number   | 0    | 0    | 1    | 1    | 0    | 0    | 0    | 1    | 31H       | 1                 |
| 77       | Module part number   | 0    | 0    | 1    | 1    | 0    | 0    | 0    | 0    | 30H       | 0                 |
| 78       | Module part number   | 0    | 1    | 0    | 1    | 0    | 0    | 1    | 0    | 52H       | R                 |
| 79       | Module part number   | 0    | 1    | 0    | 0    | 0    | 1    | 0    | 0    | 44H       | D                 |
| 80       | Module part number   | 0    | 0    | 1    | 1    | 0    | 1    | 0    | 0    | 34H       | 4                 |
| 81       | Module part number   | 0    | 1    | 0    | 0    | 0    | 0    | 0    | 1    | 41H       | A                 |
| 82       | Module part number   | 0    | 1    | 0    | 0    | 0    | 1    | 0    | 1    | 45H       | E                 |
| 83       | Module part number   | 0    | 1    | 0    | 0    | 0    | 1    | 1    | 0    | 46H       | F                 |
| 84       | Module part number   | 0    | 1    | 0    | 0    | 0    | 0    | 0    | 1    | 41H       | A                 |
| 85       | Module part number   | 0    | 0    | 1    | 0    | 1    | 1    | 0    | 1    | 2DH       | —                 |
| 86       | Module part number   | 0    | 0    | 1    | 1    | 0    | 1    | 1    | 0    | 36H       | 6                 |
| 87       | Module part number   | 0    | 1    | 0    | 0    | 0    | 1    | 0    | 1    | 45H       | E                 |
| 88       | Module part number   | 0    | 0    | 1    | 0    | 1    | 1    | 0    | 1    | 2DH       | —                 |
| 89       | Module part number   | 0    | 1    | 0    | 0    | 0    | 1    | 0    | 1    | 45H       | E                 |
| 90       | Module part number   | 0    | 0    | 1    | 0    | 0    | 0    | 0    | 0    | 20H       | (Space)           |
| 91       | Revision code  | 0    | 0    | 1    | 1    | 0    | 0    | 0    | 0    | 30H       | Initial           |
| 92       | Revision code  | 0    | 0    | 1    | 0    | 0    | 0    | 0    | 0    | 20H       | (Space)           |

| Byte No.  | Function described        | Bit7 | Bit6 | Bit5 | Bit4 | Bit3 | Bit2 | Bit1 | Bit0 | Hex value | Comments        |
|-----------|---------------------------|------|------|------|------|------|------|------|------|-----------|-----------------|
| 93        | Manufacturing date        | x    | x    | x    | x    | x    | x    | x    | x    | xx        | Year code (BCD) |
| 94        | Manufacturing date        | x    | x    | x    | x    | x    | x    | x    | x    | xx        | Week code (BCD) |
| 95 to 98  | Module serial number      |      |      |      |      |      |      |      |      |           |                 |
| 99 to 127 | Manufacture specific data |      |      |      |      |      |      |      |      |           |                 |

Note: 1. These specifications are defined based on component specification, not module.

EOL Product

Block Diagram

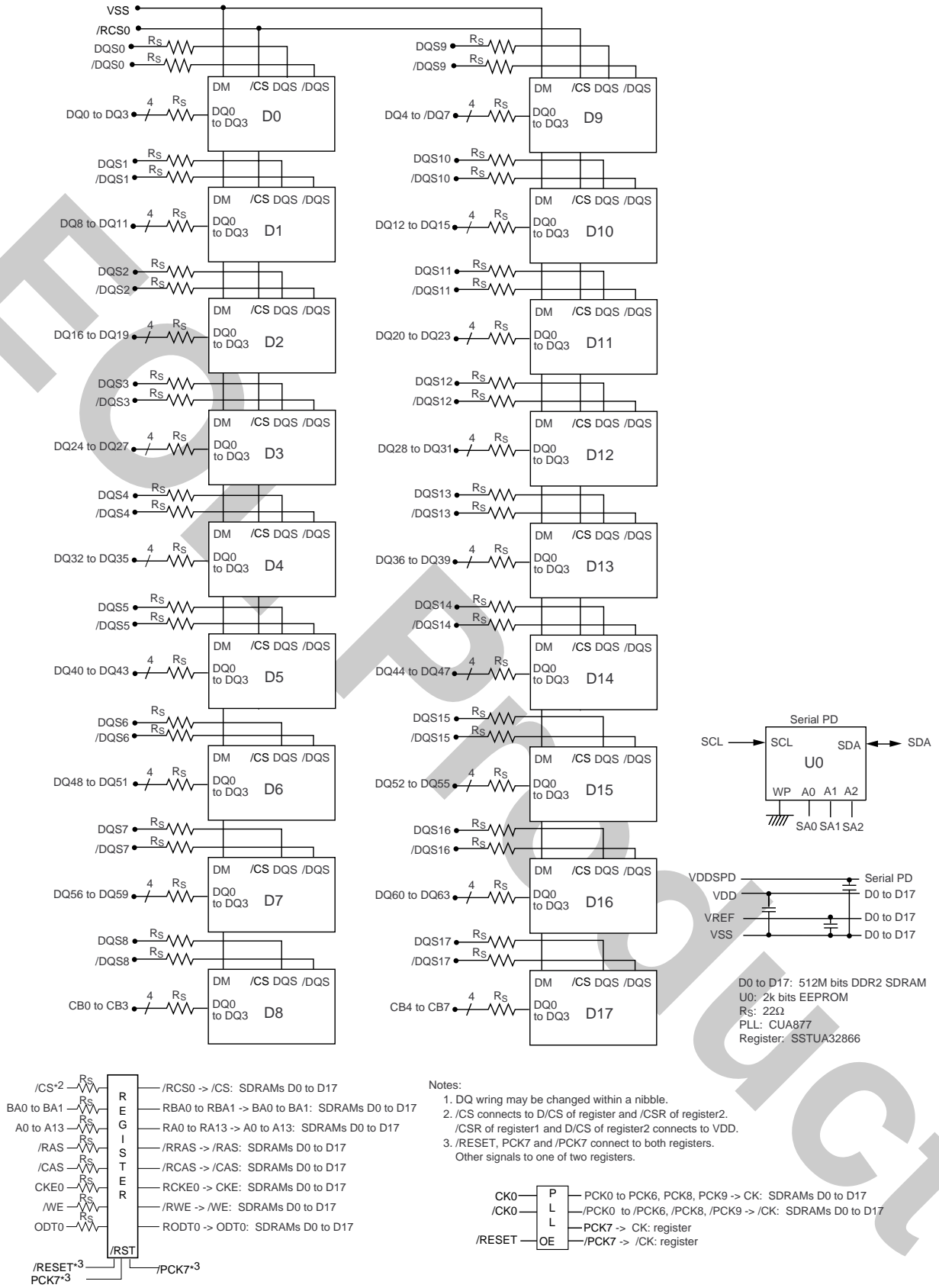

Differential Clock Net Wiring (CK0, /CK0)

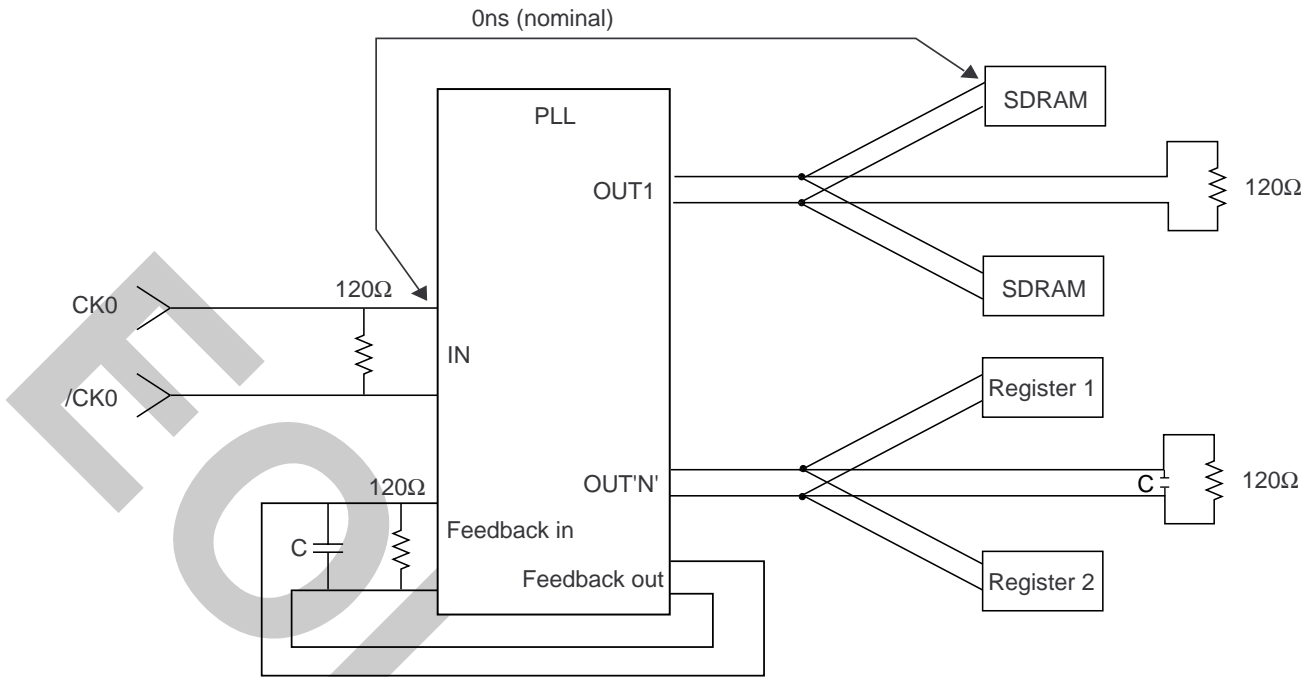

- Notes:
1. The clock delay from the input of the PLL clock to the input of any SDRAM or register will be set to 0ns (nominal).
  2. Input, output and feedback clock lines are terminated from line to line as shown, and not from line to ground.
  3. Only one PLL output is shown per output type. Any additional PLL outputs will be wired in a similar manner.
  4. Termination resistors for the PLL feedback path clocks are located as close to the input pin of the PLL as possible.

**Electrical Specifications**

- All voltages are referenced to VSS (GND).

**Absolute Maximum Ratings**

| Parameter                          | Symbol | Value        | Unit | Note |
|------------------------------------|--------|--------------|------|------|
| Voltage on any pin relative to VSS | VT     | -0.5 to +2.3 | V    | 1    |
| Supply voltage relative to VSS     | VDD    | -0.5 to +2.3 | V    |      |
| Short circuit output current       | IOS    | 50           | mA   | 1    |
| Power dissipation                  | PD     | 18           | W    |      |
| Operating case temperature         | TC     | 0 to +95     | °C   | 1, 2 |
| Storage temperature                | Tstg   | -55 to +100  | °C   | 1    |

Note: 1. DDR2 SDRAM component specification.

2. Supporting 0°C to +85°C and being able to extend to +95°C with doubling auto-refresh commands in frequency to a 32ms period (tREFI = 3.9µs) and higher temperature self-refresh entry via the control of EMRS (2) bit A7 is required.

**Caution**

**Exposing the device to stress above those listed in Absolute Maximum Ratings could cause permanent damage. The device is not meant to be operated under conditions outside the limits described in the operational section of this specification. Exposure to Absolute Maximum Rating conditions for extended periods may affect device reliability.**

**DC Operating Conditions (TC = 0°C to +85°C) (DDR2 SDRAM Component Specification)**

| Parameter               | Symbol    | min.         | typ.        | max.         | Unit | Notes |
|-------------------------|-----------|--------------|-------------|--------------|------|-------|
| Supply voltage          | VDD, VDDQ | 1.7          | 1.8         | 1.9          | V    | 4     |
|                         | VSS       | 0            | 0           | 0            | V    |       |
|                         | VDDSPD    | 1.7          | —           | 3.6          | V    |       |
| Input reference voltage | VREF      | 0.49 × VDDQ  | 0.50 × VDDQ | 0.51 × VDDQ  | V    | 1, 2  |
| Termination voltage     | VTT       | VREF - 0.04  | VREF        | VREF + 0.04  | V    | 3     |
| DC input logic high     | VIH (DC)  | VREF + 0.125 | —           | VDDQ + 0.3V  | V    |       |
| DC input low            | VIL (DC)  | -0.3         | —           | VREF - 0.125 | V    |       |
| AC input logic high     | VIH (AC)  | VREF + 0.200 | —           | —            | V    |       |
| AC input low            | VIL (AC)  | —            | —           | VREF - 0.200 | V    |       |

Notes: 1. The value of VREF may be selected by the user to provide optimum noise margin in the system. Typically the value of VREF is expected to be about 0.5 × VDDQ of the transmitting device and VREF are expected to track variations in VDDQ.

2. Peak to peak AC noise on VREF may not exceed ±2% VREF (DC).
3. VTT of transmitting device must track VREF of receiving device.
4. VDDQ must be equal to VDD.

DC Characteristics 1 (TC = 0°C to +85°C, VDD = 1.8V ± 0.1V, VSS = 0V)

| Parameter                                 | Symbol  | Grade | max. | Unit | Test condition  |
|---|---------|-------|------|------|---|
| Operating current (ACT-PRE)               | IDD0    |       | 2570 | mA   | one bank; tCK = tCK (IDD), tRC = tRC (IDD), tRAS = tRAS min.(IDD);<br>CKE is H, /CS is H between valid commands;<br>Address bus inputs are SWITCHING;<br>Data bus inputs are SWITCHING  |
| Operating current (ACT-READ-PRE)          | IDD1    |       | 2920 | mA   | one bank; IOOUT = 0mA;<br>BL = 4, CL = CL(IDD), AL = 0;<br>tCK = tCK (IDD), tRC = tRC (IDD), tRAS = tRAS min.(IDD); tRCD = tRCD (IDD);<br>CKE is H, /CS is H between valid commands;<br>Address bus inputs are SWITCHING;<br>Data pattern is same as IDD4W            |
| Precharge power-down standby current      | IDD2P   |       | 750  | mA   | all banks idle;<br>tCK = tCK (IDD);<br>CKE is L;<br>Other control and address bus inputs are STABLE;<br>Data bus inputs are FLOATING  |
| Precharge quiet standby current           | IDD2Q   |       | 1020 | mA   | all banks idle;<br>tCK = tCK (IDD);<br>CKE is H, /CS is H;<br>Other control and address bus inputs are STABLE;<br>Data bus inputs are FLOATING  |
| Idle standby current                      | IDD2N   |       | 1200 | mA   | all banks idle;<br>tCK = tCK (IDD);<br>CKE is H, /CS is H;<br>Other control and address bus inputs are SWITCHING;<br>Data bus inputs are SWITCHING  |
| Active power-down standby current         | IDD3P-F |       | 1290 | mA   | all banks open;<br>tCK = tCK (IDD);<br>CKE is L;<br>Other control and address bus inputs are STABLE;<br>Data bus inputs are FLOATING  |
|   | IDD3P-S |       | 1020 | mA   | Fast PDN Exit<br>MRS(12) = 0<br>Slow PDN Exit<br>MRS(12) = 1  |
| Active standby current                    | IDD3N   |       | 1850 | mA   | all banks open;<br>tCK = tCK (IDD), tRAS = tRAS max.(IDD), tRP = tRP (IDD);<br>CKE is H, /CS is H between valid commands;<br>Other control and address bus inputs are SWITCHING;<br>Data bus inputs are SWITCHING   |
| Operating current (Burst read operating)  | IDD4R   |       | 4270 | mA   | all banks open, continuous burst reads, IOOUT = 0mA;<br>BL = 4, CL = CL(IDD), AL = 0;<br>tCK = tCK (IDD), tRAS = tRAS max.(IDD), tRP = tRP (IDD);<br>CKE is H, /CS is H between valid commands;<br>Address bus inputs are SWITCHING;<br>Data pattern is same as IDD4W |
| Operating current (Burst write operating) | IDD4W   |       | 4090 | mA   | all banks open, continuous burst writes;<br>BL = 4, CL = CL(IDD), AL = 0;<br>tCK = tCK (IDD), tRAS = tRAS max.(IDD), tRP = tRP (IDD);<br>CKE is H, /CS is H between valid commands;<br>Address bus inputs are SWITCHING;<br>Data bus inputs are SWITCHING             |

| Parameter                                | Symbol | Grade | max. | Unit | Test condition  |
|--|--------|-------|------|------|---|
| Auto-refresh current                     | IDD5   |       | 5440 | mA   | tCK = tCK (IDD);<br>Refresh command at every tRFC (IDD) interval;<br>CKE is H, /CS is H between valid commands;<br>Other control and address bus inputs are SWITCHING;<br>Data bus inputs are SWITCHING   |
| Self-refresh current                     | IDD6   |       | 150  | mA   | Self Refresh Mode;<br>CK and /CK at 0V;<br>CKE ≤ 0.2V;<br>Other control and address bus inputs are FLOATING;<br>Data bus inputs are FLOATING  |
| Operating current<br>(Bank interleaving) | IDD7   |       | 6380 | mA   | all bank interleaving reads, IOOUT = 0mA;<br>BL = 4, CL = CL(IDD), AL = tRCD (IDD) - 1 × tCK (IDD);<br>tCK = tCK (IDD), tRC = tRC (IDD), tRRD = tRRD(IDD),<br>tRCD = 1 × tCK (IDD);<br>CKE is H, CS is H between valid commands;<br>Address bus inputs are STABLE during DESELECTs;<br>Data pattern is same as IDD4W; |

- Notes: 1. IDD specifications are tested after the device is properly initialized.  
 2. Input slew rate is specified by AC Input Test Condition.  
 3. IDD parameters are specified with ODT disabled.  
 4. Data bus consists of DQ, DM, DQS, /DQS, RDQS, /RDQS, LDQS, /LDQS, UDQS, and /UDQS. IDD values must be met with all combinations of EMRS bits 10 and 11.  
 5. Definitions for IDD  
 L is defined as  $V_{IN} \leq V_{IL} (AC) (max.)$   
 H is defined as  $V_{IN} \geq V_{IH} (AC) (min.)$   
 STABLE is defined as inputs stable at an H or L level  
 FLOATING is defined as inputs at  $V_{REF} = V_{DDQ}/2$   
 SWITCHING is defined as:  
 inputs changing between H and L every other clock cycle (once per two clocks) for address and control signals, and inputs changing between H and L every other data transfer (once per clock) for DQ signals not including masks or strobes.  
 6. Refer to AC Timing for IDD Test Conditions.

**AC Timing for IDD Test Conditions**

For purposes of IDD testing, the following parameters are to be utilized.

| Parameter       | DDR2-667 |      |
|-----------------|----------|------|
|                 | 5-5-5    | Unit |
| CL(IDD)         | 5        | tCK  |
| tRCD(IDD)       | 15       | ns   |
| tRC(IDD)        | 60       | ns   |
| tRRD(IDD)       | 7.5      | ns   |
| tCK(IDD)        | 3        | ns   |
| tRAS(min.)(IDD) | 45       | ns   |
| tRAS(max.)(IDD) | 70000    | ns   |
| tRP(IDD)        | 15       | ns   |
| tRFC(IDD)       | 105      | ns   |

**DC Characteristics 2 (TC = 0°C to +85°C, VDD, VDDQ = 1.8V ± 0.1V)**

**(DDR2 SDRAM Component Specification)**

| Parameter  | Symbol | Value       | Unit | Notes             |
|--|--------|-------------|------|-------------------|
| Input leakage current                                | ILI    | 2           | μA   | VDD ≥ VIN ≥ VSS   |
| Output leakage current                               | ILO    | 5           | μA   | VDDQ ≥ VOUT ≥ VSS |
| Minimum required output pull-up under AC test load   | VOH    | VTT + 0.603 | V    | 5                 |
| Maximum required output pull-down under AC test load | VOL    | VTT - 0.603 | V    | 5                 |
| Output timing measurement reference level            | VOTR   | 0.5 × VDDQ  | V    | 1                 |
| Output minimum sink DC current                       | IOL    | +13.4       | mA   | 3, 4, 5           |
| Output minimum source DC current                     | IOH    | -13.4       | mA   | 2, 4, 5           |

- Notes: 1. The VDDQ of the device under test is referenced.  
 2. VDDQ = 1.7V; VOUT = 1.42V.  
 3. VDDQ = 1.7V; VOUT = 0.28V.  
 4. The DC value of VREF applied to the receiving device is expected to be set to VTT.  
 5. After OCD calibration to 18Ω at TC = 25°C, VDD = VDDQ = 1.8V.

**DC Characteristics 3 (TC = 0°C to +85°C, VDD, VDDQ = 1.8V ± 0.1V)**

**(DDR2 SDRAM Component Specification)**

| Parameter                           | Symbol   | min.               | max.               | Unit | Notes |
|-------------------------------------|----------|--------------------|--------------------|------|-------|
| AC differential input voltage       | VID (AC) | 0.5                | VDDQ + 0.6         | V    | 1, 2  |
| AC differential cross point voltage | VIX (AC) | 0.5 × VDDQ - 0.175 | 0.5 × VDDQ + 0.175 | V    | 2     |
| AC differential cross point voltage | VOX (AC) | 0.5 × VDDQ - 0.125 | 0.5 × VDDQ + 0.125 | V    | 3     |

- Notes: 1. VID(AC) specifies the input differential voltage |VTR -VCP| required for switching, where VTR is the true input signal (such as CK, DQS, LDQS or UDQS) and VCP is the complementary input signal (such as /CK, /DQS, /LDQS or /UDQS). The minimum value is equal to VIH(AC) - VIL(AC).  
 2. The typical value of VIX(AC) is expected to be about 0.5 × VDDQ of the transmitting device and VIX(AC) is expected to track variations in VDDQ . VIX(AC) indicates the voltage at which differential input signals must cross.  
 3. The typical value of VOX(AC) is expected to be about 0.5 × VDDQ of the transmitting device and VOX(AC) is expected to track variations in VDDQ . VOX(AC) indicates the voltage at which differential output signals must cross.

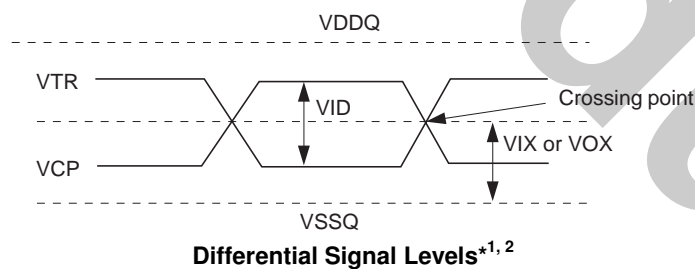

**ODT DC Electrical Characteristics (TC = 0°C to +85°C, VDD, VDDQ = 1.8V ± 0.1V)**

**(DDR2 SDRAM Component Specification)**

| Parameter   | Symbol    | min. | typ. | max. | Unit | Note |
|---|-----------|------|------|------|------|------|
| Rtt effective impedance value for EMRS (A6, A2) = 0, 1; 75 Ω  | Rtt1(eff) | 60   | 75   | 90   | Ω    | 1    |
| Rtt effective impedance value for EMRS (A6, A2) = 1, 0; 150 Ω | Rtt2(eff) | 120  | 150  | 180  | Ω    | 1    |
| Rtt effective impedance value for EMRS (A6, A2) = 1, 1; 50 Ω  | Rtt3(eff) | 40   | 50   | 60   | Ω    | 1    |
| Deviation of VM with respect to VDDQ/2                        | ΔVM       | -6   | —    | +6   | %    | 1    |

Note: 1. Test condition for Rtt measurements.

**Measurement Definition for Rtt(eff)**

Apply VIH (AC) and VIL (AC) to test pin separately, then measure current I(VIH(AC)) and I(VIL(AC)) respectively. VIH(AC), and VDDQ values defined in SSTL\_18.

$$R_{tt}(\text{eff}) = \frac{V_{IH}(\text{AC}) - V_{IL}(\text{AC})}{I(V_{IH}(\text{AC})) - I(V_{IL}(\text{AC}))}$$

**Measurement Definition for VM**

Measure voltage (VM) at test pin (midpoint) with no load.

$$\Delta VM = \left( \frac{2 \times VM}{VDDQ} - 1 \right) \times 100\%$$

**OCD Default Characteristics (TC = 0°C to +85°C, VDD, VDDQ = 1.8V ± 0.1V)**

**(DDR2 SDRAM Component Specification)**

| Parameter                      | min  | typ. | max. | Unit | Notes |
|--------------------------------|------|------|------|------|-------|
| Output impedance               | 12.6 | 18   | 23.4 | Ω    | 1     |
| Pull-up and pull-down mismatch | 0    | —    | 4    | Ω    | 1, 2  |
| Output slew rate               | 1.5  | —    | 5    | V/ns | 3, 4  |

Notes: 1. Impedance measurement condition for output source DC current: VDDQ = 1.7V; VOUT = 1420mV; (VOUT-VDDQ)/IOH must be less than 23.4Ω for values of VOUT between VDDQ and VDDQ-280mV. Impedance measurement condition for output sink DC current: VDDQ = 1.7V; VOUT = 280mV; VOUT/IOI must be less than 23.4Ω for values of VOUT between 0V and 280mV.

- Mismatch is absolute value between pull up and pull down, both are measured at same temperature and voltage.
- Slew rate measured from VIL(AC) to VIH(AC).
- The absolute value of the slew rate as measured from DC to DC is equal to or greater than the slew rate as measured from AC to AC. This is guaranteed by design and characterization.

**Pin Capacitance (TA = 25°C, VDD = 1.8V ± 0.1V)**

| Parameter                             | Symbol | Pins                                    | min. | max. | Unit | Notes |
|---------------------------------------|--------|---|------|------|------|-------|
| Input capacitance                     | CI1    | Address, /RAS, /CAS, /WE, /CS, CKE, ODT | 2.5  | 3.5  | pF   | 1     |
| Input capacitance                     | CI2    | CK, /CK                                 | 2    | 3    | pF   | 2     |
| Data and DQS input/output capacitance | CO     | DQ, DQS, /DQS, CB                       | 2.5  | 3.5  | pF   | 3     |

- Notes: 1. Register component specification.  
 2. PLL component specification.  
 3. DDR2 SDRAM component specification.

**AC Characteristics (TC = 0°C to +85°C, VDD, VDDQ = 1.8V ± 0.1V, VSS = 0V)**  
**(DDR2 SDRAM Component Specification)**

| Parameter  | Symbol | -6E                     |           | Unit | Notes |
|--|--------|-------------------------|-----------|------|-------|
|  |        | 667                     |           |      |       |
| Frequency (Mbps)                                     |        | min.                    | max.      |      |       |
| /CAS latency   | CL     | 5                       | 5         | tCK  |       |
| Active to read or write command delay                | tRCD   | 15                      | —         | ns   |       |
| Precharge command period                             | tRP    | 15                      | —         | ns   |       |
| Active to active/auto refresh command time           | tRC    | 60                      | —         | ns   |       |
| DQ output access time from CK, /CK                   | tAC    | -450                    | +450      | ps   |       |
| DQS output access time from CK, /CK                  | tDQSK  | -400                    | +400      | ps   |       |
| CK high-level width                                  | tCH    | 0.45                    | 0.55      | tCK  |       |
| CK low-level width                                   | tCL    | 0.45                    | 0.55      | tCK  |       |
| CK half period                                       | tHP    | min.<br>(tCL, tCH)      | —         | ps   |       |
| Clock cycle time                                     | tCK    | 3000                    | 8000      | ps   |       |
| DQ and DM input hold time                            | tDH    | 175                     | —         | ps   | 5     |
| DQ and DM input setup time                           | tDS    | 100                     | —         | ps   | 4     |
| Control and Address input pulse width for each input | tIPW   | 0.6                     | —         | tCK  |       |
| DQ and DM input pulse width for each input           | tDIPW  | 0.35                    | —         | tCK  |       |
| Data-out high-impedance time from CK,/CK             | tHZ    | —                       | tAC max.  | ps   |       |
| Data-out low-impedance time from CK,/CK              | tLZ    | tAC min.                | tAC max.  | ps   |       |
| DQS-DQ skew for DQS and associated DQ signals        | tDQSQ  | —                       | 240       | ps   |       |
| DQ hold skew factor                                  | tQHS   | —                       | 340       | ps   |       |
| DQ/DQS output hold time from DQS                     | tQH    | tHP – tQHS              | —         | ps   |       |
| Write command to first DQS latching transition       | tDQSS  | WL – 0.25               | WL + 0.25 | tCK  |       |
| DQS input high pulse width                           | tDQSH  | 0.35                    | —         | tCK  |       |
| DQS input low pulse width                            | tDQSL  | 0.35                    | —         | tCK  |       |
| DQS falling edge to CK setup time                    | tDSS   | 0.2                     | —         | tCK  |       |
| DQS falling edge hold time from CK                   | tDSH   | 0.2                     | —         | tCK  |       |
| Mode register set command cycle time                 | tMRD   | 2                       | —         | tCK  |       |
| Write postamble                                      | tWPST  | 0.4                     | 0.6       | tCK  |       |
| Write preamble                                       | tWPPE  | 0.35                    | —         | tCK  |       |
| Address and control input hold time                  | tIH    | 275                     | —         | ps   | 5     |
| Address and control input setup time                 | tIS    | 200                     | —         | ps   | 4     |
| Read preamble  | tRPRE  | 0.9                     | 1.1       | tCK  |       |
| Read postamble                                       | tRPST  | 0.4                     | 0.6       | tCK  |       |
| Active to precharge command                          | tRAS   | 45                      | 70000     | ns   |       |
| Active to auto-precharge delay                       | tRAP   | tRCD min.               | —         | ns   |       |
| Active bank A to active bank B command period        | tRRD   | 7.5                     | —         | ns   |       |
| Write recovery time                                  | tWR    | 15                      | —         | ns   |       |
| Auto precharge write recovery + precharge time       | tDAL   | (tWR/tCK)+<br>(tRP/tCK) | —         | tCK  | 1     |
| Internal write to read command delay                 | tWTR   | 7.5                     | —         | ns   |       |
| Internal read to precharge command delay             | tRTP   | 7.5                     | —         | ns   |       |

| Frequency (Mbps)  | Symbol | -6E             |      | Unit | Notes |
|---|--------|-----------------|------|------|-------|
|   |        | min.            | max. |      |       |
|   |        | 667             |      |      |       |
| Exit self refresh to a non-read command                           | tXSNR  | tRFC + 10       | —    | ns   |       |
| Exit self refresh to a read command                               | tXSRD  | 200             | —    | tCK  |       |
| Exit precharge power down to any non-read command                 | tXP    | 2               | —    | tCK  |       |
| Exit active power down to read command                            | tXARD  | 2               | —    | tCK  | 3     |
| Exit active power down to read command (slow exit/low power mode) | tXARDS | 7– AL           | —    | tCK  | 2, 3  |
| CKE minimum pulse width (high and low pulse width)                | tCKE   | 3               | —    | tCK  |       |
| Output impedance test driver delay                                | tOIT   | 0               | 12   | ns   |       |
| Auto refresh to active/auto refresh command time                  | tRFC   | 105             | —    | ns   |       |
| Average periodic refresh interval (0°C ≤ TC ≤ +85°C)              | tREFI  | —               | 7.8  | μs   |       |
| (+85°C < TC ≤ +95°C)  | tREFI  | —               | 3.9  | μs   |       |
| Minimum time clocks remains ON after CKE asynchronously drops low | tDELAY | tIS + tCK + tIH | —    | ns   |       |

- Notes: 1. For each of the terms above, if not already an integer, round to the next higher integer.  
 2. AL: Additive Latency.  
 3. MRS A12 bit defines which active power down exit timing to be applied.  
 4. The figures of Input Waveform Timing 1 and 2 are referenced from the input signal crossing at the VIH(AC) level for a rising signal and VIL(AC) for a falling signal applied to the device under test.  
 5. The figures of Input Waveform Timing 1 and 2 are referenced from the input signal crossing at the VIH(DC) level for a rising signal and VIL(DC) for a falling signal applied to the device under test.

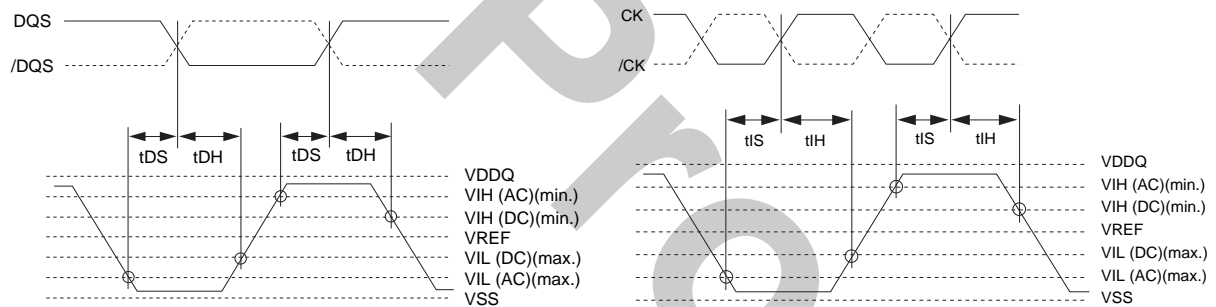

Input Waveform Timing 1 (tDS, tDH)

Input Waveform Timing 2 (tIS, tIH)

**ODT AC Electrical Characteristics (DDR2 SDRAM Component Specification)**

| Parameter                       | Symbol | min.            | max.                     | Unit | Notes |
|---------------------------------|--------|-----------------|--------------------------|------|-------|
| ODT turn-on delay               | tAOND  | 2               | 2                        | tCK  |       |
| ODT turn-on                     | tAON   | tAC(min)        | tAC(max) + 700           | ps   | 1     |
| ODT turn-on (power down mode)   | tAONPD | tAC(min) + 2000 | 2tCK + tAC(max) + 1000   | ps   |       |
| ODT turn-off delay              | tAOFD  | 2.5             | 2.5                      | tCK  |       |
| ODT turn-off                    | tAOF   | tAC(min)        | tAC(max) + 600           | ps   | 2     |
| ODT turn-off (power down mode)  | tAOFPD | tAC(min) + 2000 | 2.5tCK + tAC(max) + 1000 | ps   |       |
| ODT to power down entry latency | tANPD  | 3               | 3                        | tCK  |       |
| ODT power down exit latency     | tAXPD  | 8               | 8                        | tCK  |       |

- Notes: 1. ODT turn on time min is when the device leaves high impedance and ODT resistance begins to turn on. ODT turn on time max is when the ODT resistance is fully on. Both are measured from tAOND.  
 2. ODT turn off time min is when the device starts to turn off ODT resistance. ODT turn off time max is when the bus is in high impedance. Both are measured from tAOFD.

**AC Input Test Conditions**

| Parameter                               | Symbol       | Value      | Unit | Notes |
|---|--------------|------------|------|-------|
| Input reference voltage                 | VREF         | 0.5 × VDDQ | V    | 1     |
| Input signal maximum peak to peak swing | VSWING(max.) | 1.0        | V    | 1     |
| Input signal maximum slew rate          | SLEW         | 1.0        | V/ns | 2, 3  |

- Notes: 1. Input waveform timing is referenced to the input signal crossing through the VREF level applied to the device under test.  
 2. The input signal minimum slew rate is to be maintained over the range from VIH(DC) (max.) to VIH(AC) (min.) for rising edges and the range from VIH(DC) (min.) to VIL(AC) (max.) for falling edges as shown in the below figure.  
 3. AC timings are referenced with input waveforms switching from VIL(AC) to VIH(AC) on the positive transitions and VIH(AC) to VIL(AC) on the negative transitions.

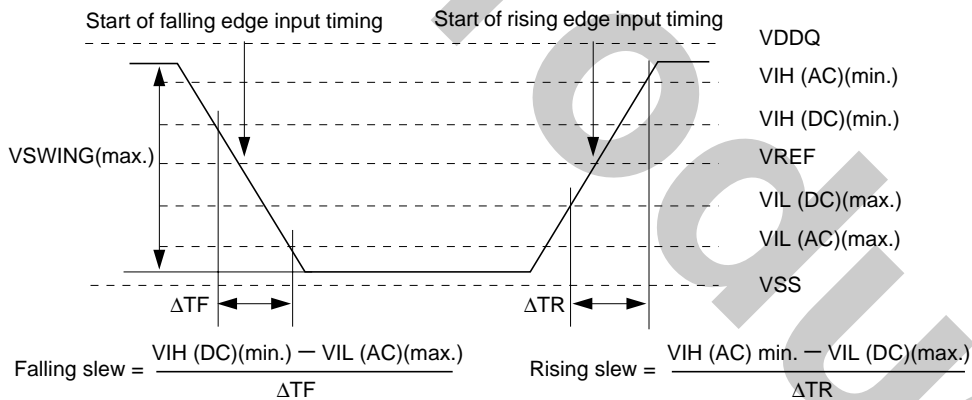

**AC Input Test Signal Wave forms**

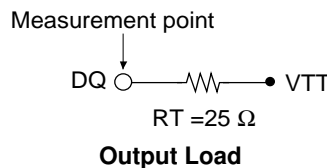

**Pin Functions**

**CK, /CK (input pin)**

The CK and the /CK are the master clock inputs. All inputs except DMs, DQSs and DQs are referred to the cross point of the CK rising edge and the VREF level. When a read operation, DQSs and DQs are referred to the cross point of the CK and the /CK. When a write operation, DQs are referred to the cross point of the DQS and the VREF level. DQSs for write operation are referred to the cross point of the CK and the /CK.

**/CS (input pin)**

When /CS is low, commands and data can be input. When /CS is high, all inputs are ignored. However, internal operations (bank active, burst operations, etc.) are held.

**/RAS, /CAS, and /WE (input pins)**

These pins define operating commands (read, write, etc.) depending on the combinations of their voltage levels. See "Command operation".

**A0 to A13 (input pins)**

Row address (AX0 to AX13) is determined by the A0 to the A13 level at the cross point of the CK rising edge and the VREF level in a bank active command cycle. Column address (AY0 to AY9, AY11) is loaded via the A0 to the A9 and A11 at the cross point of the CK rising edge and the VREF level in a read or a write command cycle. This column address becomes the starting address of a burst operation.

**A10 (AP) (input pin)**

A10 defines the precharge mode when a precharge command, a read command or a write command is issued. If A10 = high when a precharge command is issued, all banks are precharged. If A10 = low when a precharge command is issued, only the bank that is selected by BA1, BA0 is precharged. If A10 = high when read or write command, auto-precharge function is enabled. While A10 = low, auto-precharge function is disabled.

**BA0, BA1 (input pin)**

BA0, BA1 are bank select signals (BA). The memory array is divided into bank 0, bank 1, bank 2 and bank 3. (See Bank Select Signal Table)

**[Bank Select Signal Table]**

|        | BA0 | BA1 |
|--------|-----|-----|
| Bank 0 | L   | L   |
| Bank 1 | H   | L   |
| Bank 2 | L   | H   |
| Bank 3 | H   | H   |

Remark: H: VIH. L: VIL.

**CKE (input pin)**

CKE controls power down and self-refresh. The power down and the self-refresh commands are entered when the CKE is driven low and exited when it resumes to high.

The CKE level must be kept for 1 CK cycle at least, that is, if CKE changes at the cross point of the CK rising edge and the VREF level with proper setup time tIS, at the next CK rising edge CKE level must be kept with proper hold time tIH.

**DQ, CB (input and output pins)**

Data are input to and output from these pins.

**DQS (input and output pin)**

DQS and /DQS provide the read data strobes (as output) and the write data strobes (as input).

**VDD (power supply pins)**

1.8V is applied. (VDD is for the internal circuit.)

**VDDSPD (power supply pin)**

1.8V is applied (For serial EEPROM).

**VSS (power supply pin)**

Ground is connected.

**/RESET(input pin)**

LVCMOS reset input. When /RESET is Low, all registers are reset.

**Par\_IN (Parity input pin)**

Parity bit for the address and control bus.

**Err\_Out (Error output pin)**

Parity error found on the address and control bus.

**Detailed Operation Part and Timing Waveforms**

Refer to the EDE5104AESK, EDE5108AESK datasheet (E0562E). DM pins of component device fixed to VSS level on the module board. DIMM /CAS latency = component CL + 1 for registered type.

Physical Outline

Unit: mm

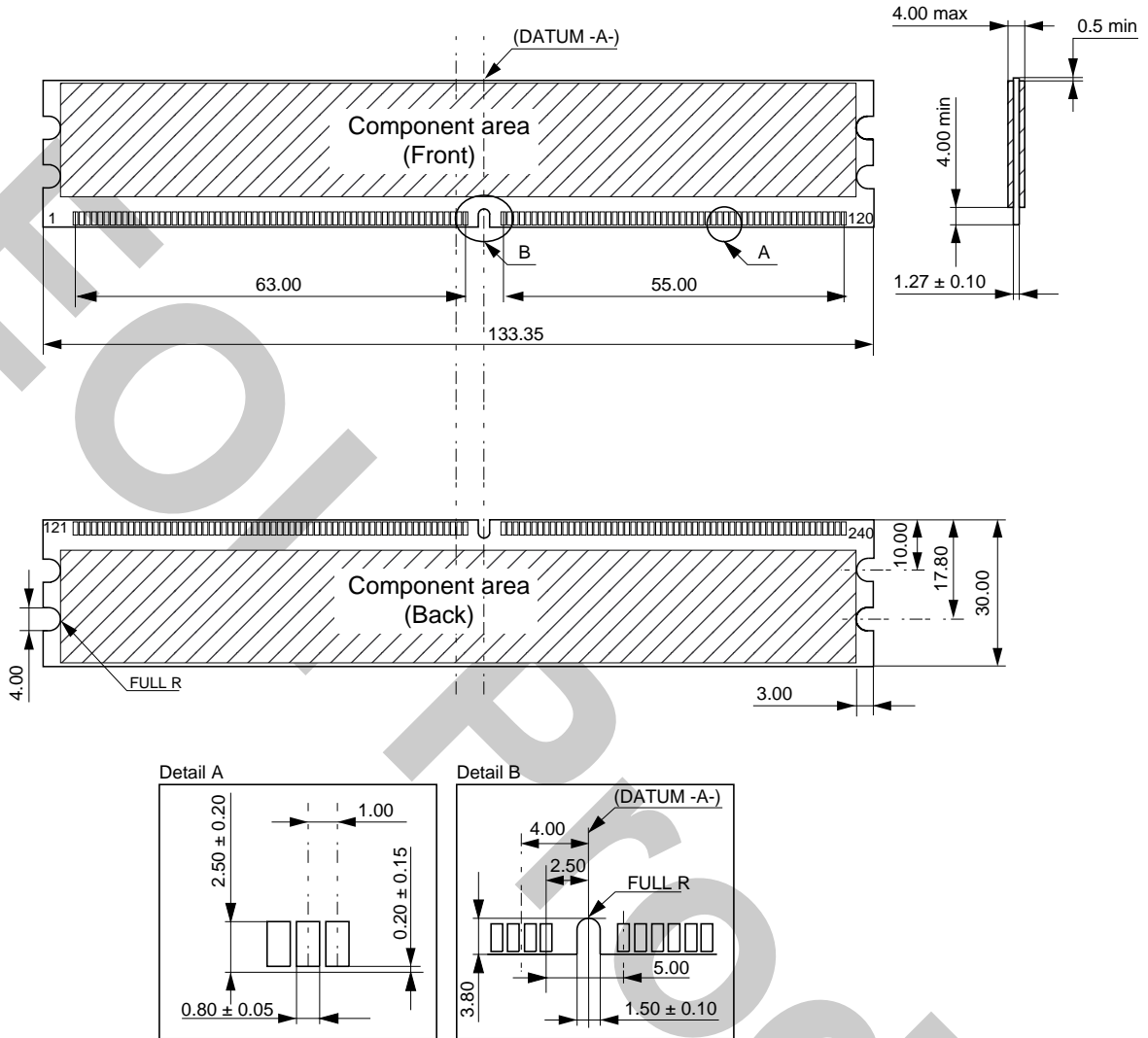

ECA-TS2-0093-01

**CAUTION FOR HANDLING MEMORY MODULES**

When handling or inserting memory modules, be sure not to touch any components on the modules, such as the memory ICs, chip capacitors and chip resistors. It is necessary to avoid undue mechanical stress on these components to prevent damaging them.

In particular, do not push module cover or drop the modules in order to protect from mechanical defects, which would be electrical defects.

When re-packing memory modules, be sure the modules are not touching each other.

Modules in contact with other modules may cause excessive mechanical stress, which may damage the modules.

MDE0202

**NOTES FOR CMOS DEVICES****① PRECAUTION AGAINST ESD FOR MOS DEVICES**

Exposing the MOS devices to a strong electric field can cause destruction of the gate oxide and ultimately degrade the MOS devices operation. Steps must be taken to stop generation of static electricity as much as possible, and quickly dissipate it, when once it has occurred. Environmental control must be adequate. When it is dry, humidifier should be used. It is recommended to avoid using insulators that easily build static electricity. MOS devices must be stored and transported in an anti-static container, static shielding bag or conductive material. All test and measurement tools including work bench and floor should be grounded. The operator should be grounded using wrist strap. MOS devices must not be touched with bare hands. Similar precautions need to be taken for PW boards with semiconductor MOS devices on it.

**② HANDLING OF UNUSED INPUT PINS FOR CMOS DEVICES**

No connection for CMOS devices input pins can be a cause of malfunction. If no connection is provided to the input pins, it is possible that an internal input level may be generated due to noise, etc., hence causing malfunction. CMOS devices behave differently than Bipolar or NMOS devices. Input levels of CMOS devices must be fixed high or low by using a pull-up or pull-down circuitry. Each unused pin should be connected to  $V_{DD}$  or GND with a resistor, if it is considered to have a possibility of being an output pin. The unused pins must be handled in accordance with the related specifications.

**③ STATUS BEFORE INITIALIZATION OF MOS DEVICES**

Power-on does not necessarily define initial status of MOS devices. Production process of MOS does not define the initial operation status of the device. Immediately after the power source is turned ON, the MOS devices with reset function have not yet been initialized. Hence, power-on does not guarantee output pin levels, I/O settings or contents of registers. MOS devices are not initialized until the reset signal is received. Reset operation must be executed immediately after power-on for MOS devices having reset function.

CME0107

The information in this document is subject to change without notice. Before using this document, confirm that this is the latest version.

No part of this document may be copied or reproduced in any form or by any means without the prior written consent of Elpida Memory, Inc.

Elpida Memory, Inc. does not assume any liability for infringement of any intellectual property rights (including but not limited to patents, copyrights, and circuit layout licenses) of Elpida Memory, Inc. or third parties by or arising from the use of the products or information listed in this document. No license, express, implied or otherwise, is granted under any patents, copyrights or other intellectual property rights of Elpida Memory, Inc. or others.

Descriptions of circuits, software and other related information in this document are provided for illustrative purposes in semiconductor product operation and application examples. The incorporation of these circuits, software and information in the design of the customer's equipment shall be done under the full responsibility of the customer. Elpida Memory, Inc. assumes no responsibility for any losses incurred by customers or third parties arising from the use of these circuits, software and information.

**[Product applications]**

Elpida Memory, Inc. makes every attempt to ensure that its products are of high quality and reliability. However, users are instructed to contact Elpida Memory's sales office before using the product in aerospace, aeronautics, nuclear power, combustion control, transportation, traffic, safety equipment, medical equipment for life support, or other such application in which especially high quality and reliability is demanded or where its failure or malfunction may directly threaten human life or cause risk of bodily injury.

**[Product usage]**

Design your application so that the product is used within the ranges and conditions guaranteed by Elpida Memory, Inc., including the maximum ratings, operating supply voltage range, heat radiation characteristics, installation conditions and other related characteristics. Elpida Memory, Inc. bears no responsibility for failure or damage when the product is used beyond the guaranteed ranges and conditions. Even within the guaranteed ranges and conditions, consider normally foreseeable failure rates or failure modes in semiconductor devices and employ systemic measures such as fail-safes, so that the equipment incorporating Elpida Memory, Inc. products does not cause bodily injury, fire or other consequential damage due to the operation of the Elpida Memory, Inc. product.

**[Usage environment]**

This product is not designed to be resistant to electromagnetic waves or radiation. This product must be used in a non-condensing environment.

If you export the products or technology described in this document that are controlled by the Foreign Exchange and Foreign Trade Law of Japan, you must follow the necessary procedures in accordance with the relevant laws and regulations of Japan. Also, if you export products/technology controlled by U.S. export control regulations, or another country's export control laws or regulations, you must follow the necessary procedures in accordance with such laws or regulations.

If these products/technology are sold, leased, or transferred to a third party, or a third party is granted license to use these products, that third party must be made aware that they are responsible for compliance with the relevant laws and regulations.

M01E0107