

256MB Unbuffered DDR SDRAM DIMM

HB54A2568FM-A75B/B75B/10B (32M words × 64 bits, 1 Bank)
HB54A2569FM-A75B/B75B/10B (32M words × 72 bits, 1 Bank)

Description

The HB54A2568FM, HB54A2569FM are Double Data Rate (DDR) SDRAM Module, mounted 256M bits DDR SDRAM (HM5425801BTT) sealed in TSOP package, and 1 piece of serial EEPROM (2k bits EEPROM) for Presence Detect (PD). The HB54A2568FM is organized as 32M × 64 × 1 bank mounted 8 pieces of 256M bits DDR SDRAM. The HB54A2569FM is organized as 32M × 72 × 1 bank mounted 9 pieces of 256M bits DDR SDRAM. Read and write operations are performed at the cross points of the CK and the /CK. This high-speed data transfer is realized by the 2 bits prefetch-pipelined architecture. Data strobe (DQS) both for read and write are available for high speed and reliable data bus design. By setting extended mode register, the on-chip Delay Locked Loop (DLL) can be set enable or disable. An outline of the products is 184-pin socket type package (dual lead out). Therefore, it makes high density mounting possible without surface mount technology. It provides common data inputs and outputs. Decoupling capacitors are mounted beside each TSOP on the module board.

Features

- 184-pin socket type package (dual lead out)
 - Outline: 133.35mm (Length) × 31.75mm (Height) × 4.00mm (Thickness)
 - Lead pitch: 1.27mm
- 2.5V power supply (VCC/VCCQ)
- SSTL-2 interface for all inputs and outputs
- Clock frequency: 143MHz/133MHz/125MHz (max.)
- Data inputs, outputs and DM are synchronized with DQS
- 4 banks can operate simultaneously and independently (Component)
- Burst read/write operation
- Programmable burst length: 2, 4, 8
 - Burst read stop capability
- Programmable burst sequence
 - Sequential
 - Interleave
- Start addressing capability
 - Even and Odd
- Programmable /CAS latency (CL): 2, 2.5
- 8192 refresh cycles: 7.8μs (8192/64ms)
- 2 variations of refresh
 - Auto refresh
 - Self refresh

Ordering Information

Part number	Clock frequency MHz (max.)	/CAS latency	Package	Contact pad
HB54A2568FM-A75B* ¹	143 MHz	2.5	184-pin dual lead out socket type	Gold
HB54A2568FM-B75B* ²	133 MHz	2.5		
HB54A2568FM-10B* ²	125 MHz	2.5		
HB54A2569FM-A75B* ¹	143 MHz	2.5		
HB54A2569FM-B75B* ²	133 MHz	2.5		
HB54A2569FM-10B* ²	125 MHz	2.5		

- Notes: 1. 133 MHz operation at /CAS latency = 2.
2. 100 MHz operation at /CAS latency = 2.

Pin Configurations

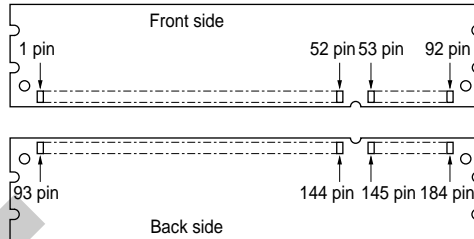

Pin No.	Pin name	Pin No.	Pin name	Pin No.	Pin name	Pin No.	Pin name
1	VREF	47	DQS8 (NC)* ¹	93	VSS	139	VSS
2	DQ0	48	A0	94	DQ4	140	DM8/DQS17 (NC)* ¹
3	VSS	49	CB2 (NC)* ¹	95	DQ5	141	A10
4	DQ1	50	VSS	96	VCCQ	142	CB6 (NC)* ¹
5	DQS0	51	CB3	97	DM0/DQS9	143	VCCQ
6	DQ2	52	BA1 (NC)* ¹	98	DQ6	144	CB7 (NC)* ¹
7	VCC	53	DQ32	99	DQ7	145	VSS
8	DQ3	54	VCCQ	100	VSS	146	DQ36
9	NC	55	DQ33	101	NC	147	DQ37
10	NC	56	DQS4	102	NC	148	VCC
11	VSS	57	DQ34	103	NC	149	DM4/DQS13
12	DQ8	58	VSS	104	VCCQ	150	DQ38
13	DQ9	59	BA0	105	DQ12	151	DQ39
14	DQS1	60	DQ35	106	DQ13	152	VSS
15	VCCQ	61	DQ40	107	DM1/DQS10	153	DQ44
16	CK1	62	VCCQ	108	VCC	154	/RAS
17	/CK1	63	/WE	109	DQ14	155	DQ45
18	VSS	64	DQ41	110	DQ15	156	VCCQ
19	DQ10	65	/CAS	111	NC	157	/S0
20	DQ11	66	VSS	112	VCCQ	158	NC
21	CKE0	67	DQS5	113	NC	159	DM5/DQS14
22	VCCQ	68	DQ42	114	DQ20	160	VSS
23	DQ16	69	DQ43	115	A12	161	DQ46
24	DQ17	70	VCC	116	VSS	162	DQ47
25	DQS2	71	NC	117	DQ21	163	NC
26	VSS	72	DQ48	118	A11	164	VCCQ

HB54A2568FM, HB54A2569FM-A75B/B75B/10B

Pin No.	Pin name	Pin No.	Pin name	Pin No.	Pin name	Pin No.	Pin name
27	A9	73	DQ49	119	DM2/DQS11	165	DQ52
28	DQ18	74	VSS	120	VCC	166	DQ53
29	A7	75	/CK2	121	DQ22	167	NC
30	VCCQ	76	CK2	122	A8	168	VCC
31	DQ19	77	VCCQ	123	DQ23	169	DM6/DQS15
32	A5	78	DQS6	124	VSS	170	DQ54
33	DQ24	79	DQ50	125	A6	171	DQ55
34	VSS	80	DQ51	126	DQ28	172	VCCQ
35	DQ25	81	VSS	127	DQ29	173	NC
36	DQS3	82	VCCID	128	VCCQ	174	DQ60
37	A4	83	DQ56	129	DM3/DQS12	175	DQ61
38	VCC	84	DQ57	130	A3	176	VSS
39	DQ26	85	VCC	131	DQ30	177	DM7/DQS16
40	DQ27	86	DQS7	132	VSS	178	DQ62
41	A2	87	DQ58	133	DQ31	179	DQ63
42	VSS	88	DQ59	134	CB4 (NC)* ¹	180	VCCQ
43	A1	89	VSS	135	CB5 (NC)* ¹	181	SA0
44	CB0 (NC)* ¹	90	NC	136	VCCQ	182	SA1
45	CB1 (NC)* ¹	91	SDA	137	CK0	183	SA2
46	VCC	92	SCL	138	/CK0	184	VCCSPD

Note: 1. The HB54A2568FM assign "NC".

Pin Description

Pin name	Function
A0 to A12	Address input Row address A0 to A12 Column address A0 to A9
BA0, BA1	Bank select address
DQ0 to DQ63	Data input/output
CB0 to CB7	Check bit (Data input/output)
/RAS	Row address strobe command
/CAS	Column address strobe command
/WE	Write enable
/S0	Chip select
CKE0	Clock enable
CK0 to CK2	Clock input
/CK0 to /CK2	Differential clock input
DQS0 to DQS8	Input and output data strobe
DM0 to DM8/DQS9 to DQS17	Input mask
SCL	Clock input for serial PD
SDA	Data input/output for serial PD
SA0 to SA2	Serial address input
VCC	Power for internal circuit
VCCQ	Power for DQ circuit
VCCSPD	Power for serial EEPROM
VREF	Input reference voltage
VSS	Ground
VCCID	VCC identification flag
NC	No connection

Serial PD Matrix*1

Byte No.	Function described	Bit7	Bit6	Bit5	Bit4	Bit3	Bit2	Bit1	Bit0	Hex value	Comments
0	Number of bytes utilized by module manufacturer	1	0	0	0	0	0	0	0	80	128
1	Total number of bytes in serial PD device	0	0	0	0	1	0	0	0	08	256 byte
2	Memory type	0	0	0	0	0	1	1	1	07	SDRAM DDR
3	Number of row address	0	0	0	0	1	1	0	1	0D	13
4	Number of column address	0	0	0	0	1	0	1	0	0A	10
5	Number of DIMM banks	0	0	0	0	0	0	0	1	01	1
6	Module data width HB54A2568FM	0	1	0	0	0	0	0	0	40	64 bits
	HB54A2569FM	0	1	0	0	1	0	0	0	48	72 bits
7	Module data width continuation	0	0	0	0	0	0	0	0	00	0 (+)
8	Voltage interface level of this assembly	0	0	0	0	0	1	0	0	04	SSTL 2.5V
9	DDR SDRAM cycle time, CL = X -A75B	0	1	1	1	0	0	0	0	70	CL = 2.5*5
	-B75B	0	1	1	1	0	1	0	1	75	
	-10B	1	0	0	0	0	0	0	0	80	
10	SDRAM access from clock (tAC) -A75B/B75B	0	1	1	1	0	1	0	1	75	0.75ns*5
	-10B	1	0	0	0	0	0	0	0	80	0.8ns*5
11	DIMM configuration type HB54A2568FM	0	0	0	0	0	0	0	0	00	None
	HB54A2569FM	0	0	0	0	0	0	1	0	02	ECC
12	Refresh rate/type	1	0	0	0	0	0	1	0	82	7.8 μs Self refresh
13	Primary SDRAM width	0	0	0	0	1	0	0	0	08	× 8
14	Error checking SDRAM width HB54A2568FM	0	0	0	0	0	0	0	0	00	None
	HB54A2569FM	0	0	0	0	1	0	0	0	08	× 8
15	SDRAM device attributes: Minimum clock delay back-to-back column access	0	0	0	0	0	0	0	1	01	1 CLK
16	SDRAM device attributes: Burst length supported	0	0	0	0	1	1	1	0	0E	2, 4, 8
17	SDRAM device attributes: Number of banks on SDRAM device	0	0	0	0	0	1	0	0	04	4
18	SDRAM device attributes: /CAS latency	0	0	0	0	1	1	0	0	0C	2, 2.5
19	SDRAM device attributes: /CS latency	0	0	0	0	0	0	0	1	01	0
20	SDRAM device attributes: /WE latency	0	0	0	0	0	0	1	0	02	1
21	SDRAM module attributes	0	0	1	0	0	0	0	0	20	Unbuffered
22	SDRAM device attributes: General	1	1	0	0	0	0	0	0	C0	± 0.2V
23	Minimum clock cycle time at CLX - 0.5 -A75B	0	1	1	1	0	1	0	1	75	CL = 2*5
	-B75B/10B	1	0	1	0	0	0	0	0	A0	
24	Maximum data access time (tAC) from clock at CLX - 0.5 -A75B/B75B	0	1	1	1	0	1	0	1	75	0.75ns*5
	-10B	1	0	0	0	0	0	0	0	80	0.8ns*5

HB54A2568FM, HB54A2569FM-A75B/B75B/10B

Byte No.	Function described	Bit7	Bit6	Bit5	Bit4	Bit3	Bit2	Bit1	Bit0	Hex value	Comments
25	Minimum clock cycle time at CLX - 1	0	0	0	0	0	0	0	0	00	
26	Maximum data access time (tAC) from clock at CLX - 1	0	0	0	0	0	0	0	0	00	
27	Minimum row precharge time (tRP)	0	1	0	1	0	0	0	0	50	20ns
28	Minimum row active to row active delay (tRRD)	0	0	1	1	1	1	0	0	3C	15ns
29	Minimum /RAS to /CAS delay (tRCD)	0	1	0	1	0	0	0	0	50	20ns
30	Minimum active to precharge time (tRAS)	0	0	1	0	1	1	0	1	2D	45ns
	-A75B/B75B										
	-10B	0	0	1	1	0	0	1	0	32	50ns
31	Module bank density	0	1	0	0	0	0	0	0	40	1 bank 256MB
32	Address and command setup time before clock (tIS)	1	0	0	1	0	0	0	0	90	0.9ns* ⁵
	-A75B/B75B										
	-10B	1	0	1	1	0	0	0	0	B0	1.1ns* ⁵
33	Address and command hold time after clock (tIH)	1	0	0	1	0	0	0	0	90	0.9ns* ⁵
	-A75B/B75B										
	-10B	1	0	1	1	0	0	0	0	B0	1.1ns* ⁵
34	Data input setup time before clock (tDS)	0	1	0	1	0	0	0	0	50	0.5ns* ⁵
	-A75B/B75B										
	-10B	0	1	1	0	0	0	0	0	60	0.6ns* ⁵
35	Data input hold time after clock (tDH)	0	1	0	1	0	0	0	0	50	0.5ns* ⁵
	-A75B/B75B										
	-10B	0	1	1	0	0	0	0	0	60	0.6ns* ⁵
36 to 40	Superset information	0	0	0	0	0	0	0	0	00	Future use
41	Active command period (tRC)	0	1	0	0	0	0	0	1	41	65ns* ⁵
	-A75B/B75B										
	-10B	0	1	0	0	0	1	1	0	46	70ns* ⁵
42	Auto refresh to active/ Auto refresh command cycle (tRFC)	0	1	0	0	1	0	1	1	4B	75ns* ⁵
	-A75B/B75B										
	-10B	0	1	0	1	0	0	0	0	50	80ns* ⁵
43	SDRAM tCK cycle max. (tCK max.)	0	0	1	1	0	0	0	0	30	12ns* ⁵
44	Dout to DQS skew	0	0	1	1	0	0	1	0	32	500ps* ⁵
	-A75B/B75B										
	-10B	0	0	1	1	1	1	0	0	3C	600ps* ⁵
45	Data hold skew (tQHS)	0	1	1	1	0	1	0	1	75	750ps* ⁵
	-A75B/B75B										
	-10B	1	0	1	0	0	0	0	0	A0	1000ps* ⁵
46 to 61	Superset information	0	0	0	0	0	0	0	0	00	Future use
62	SPD revision	0	0	0	0	0	0	0	0	00	Initial

HB54A2568FM, HB54A2569FM-A75B/B75B/10B

Byte No.	Function described	Bit7	Bit6	Bit5	Bit4	Bit3	Bit2	Bit1	Bit0	Hex value	Comments
63	Checksum for bytes 0 to 62 HB54A2568FM-A75B	1	0	1	1	0	0	1	0	B2	178
	HB54A2568FM-B75B	1	1	1	0	0	0	1	0	E2	226
	HB54A2568FM-10B	1	0	1	0	0	1	1	1	A7	167
	HB54A2569FM-A75B	1	1	0	0	0	1	0	0	C4	196
	HB54A2569FM-B75B	1	1	1	1	0	1	0	0	F4	244
	HB54A2569FM-10B	1	0	1	1	1	0	0	1	B9	185
64	Manufacturer's JEDEC ID code	0	0	0	0	0	1	1	1	07	HITACHI
65 to 71	Manufacturer's JEDEC ID code	0	0	0	0	0	0	0	0	00	
72	Manufacturing location	×	×	×	×	×	×	×	×	×	*2 (ASCII-8bit code)
73	Module part number	0	1	0	0	1	0	0	0	48	H
74	Module part number	0	1	0	0	0	0	1	0	42	B
75	Module part number	0	0	1	1	0	1	0	1	35	5
76	Module part number	0	0	1	1	0	1	0	0	34	4
77	Module part number	0	1	0	0	0	0	0	1	41	A
78	Module part number	0	0	1	1	0	0	1	0	32	2
79	Module part number	0	0	1	1	0	1	0	1	35	5
80	Module part number	0	0	1	1	0	1	1	0	36	6
81	Module part number HB54A2568FM	0	0	1	1	1	0	0	0	38	8
	HB54A2569FM	0	0	1	1	1	0	0	1	39	9
82	Module part number	0	1	0	0	0	1	1	0	46	F
83	Module part number	0	1	0	0	1	1	0	1	4D	M
84	Module part number	0	0	1	0	1	1	0	1	2D	—
85	Module part number -A75B	0	1	0	0	0	0	0	1	41	A
	-B75B	0	1	0	0	0	0	1	0	42	B
	-10B	0	0	1	1	0	0	0	1	31	1
86	Module part number -A75B/B75B	0	0	1	1	0	1	1	1	37	7
	-10B	0	0	1	1	0	0	0	0	30	0
87	Module part number -A75B/B75B	0	0	1	1	0	1	0	1	35	5
	-10B	0	1	0	0	0	0	1	0	42	B
88	Module part number -A75B/B75B	0	1	0	0	0	0	1	0	42	B
	-10B	0	0	1	0	0	0	0	0	20	(Space)
89 to 90	Module part number	0	0	1	0	0	0	0	0	20	(Space)
91	Revision code	0	0	1	1	0	0	0	0	30	Initial
92	Revision code	0	0	1	0	0	0	0	0	20	(Space)
93	Manufacturing date	×	×	×	×	×	×	×	×	×	Year code (BCD)
94	Manufacturing date	×	×	×	×	×	×	×	×	×	Week code (BCD)
95 to 98	Module serial number	*3									
99 to 127	Manufacturer specific data	*4									

- Notes:
1. All serial PD data are not protected. 0: Serial data, "driven Low", 1: Serial data, "driven High" These SPD are based on JEDEC Committee Ballot JC-42.5-99-129.
 2. Byte72 is manufacturing location code. (ex: In case of Japan, byte72 is 4AH. 4AH shows "J" on ASCII code.)
 3. Bytes 95 through 98 are assembly serial number.
 4. All bits of 99 through 127 are not defined ("1" or "0").
 5. These specifications are defined based on component specification, not module.

Block Diagram (HB54A2568FM)

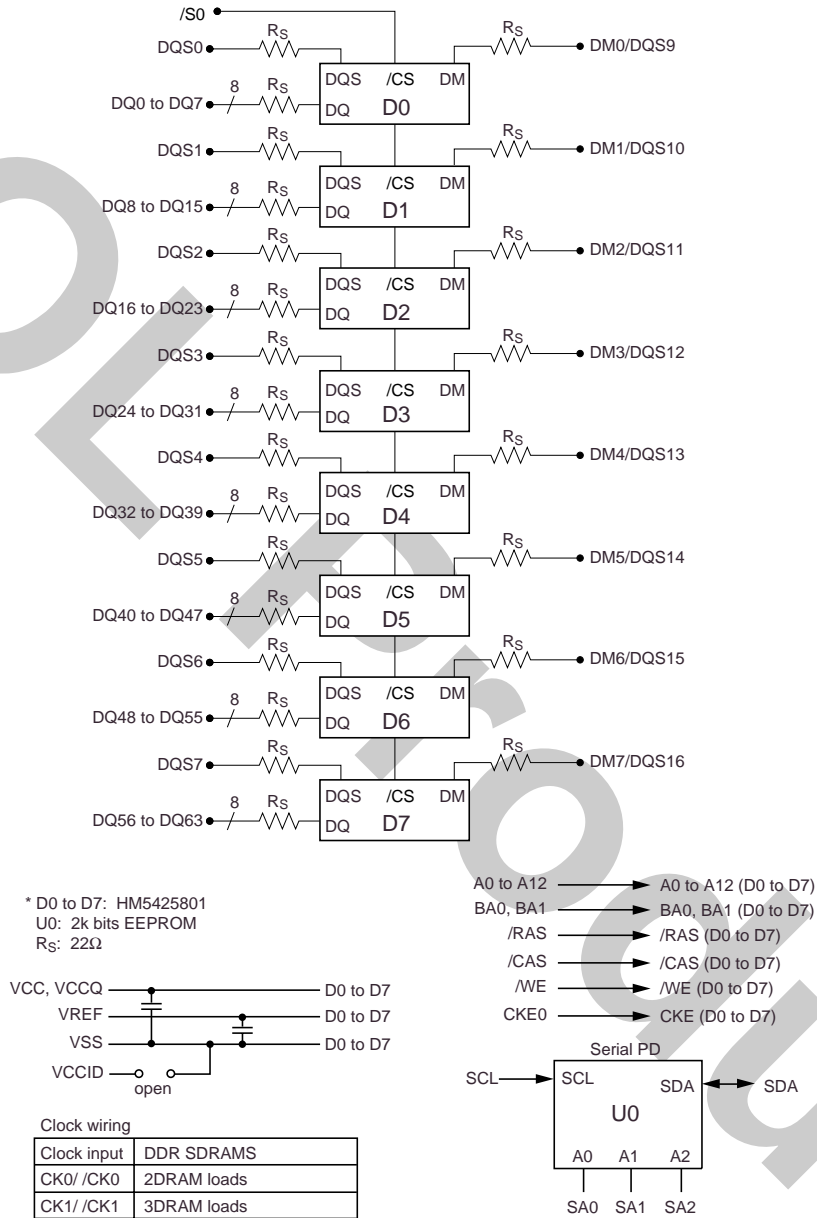

- Notes:
1. The SDA pull-up resistor is required due to the open-drain/open-collector output.
 2. The SCL pull-up resistor is recommended because of the normal SCL line inactive "high" state.

Block Diagram (HB54A2569FM)

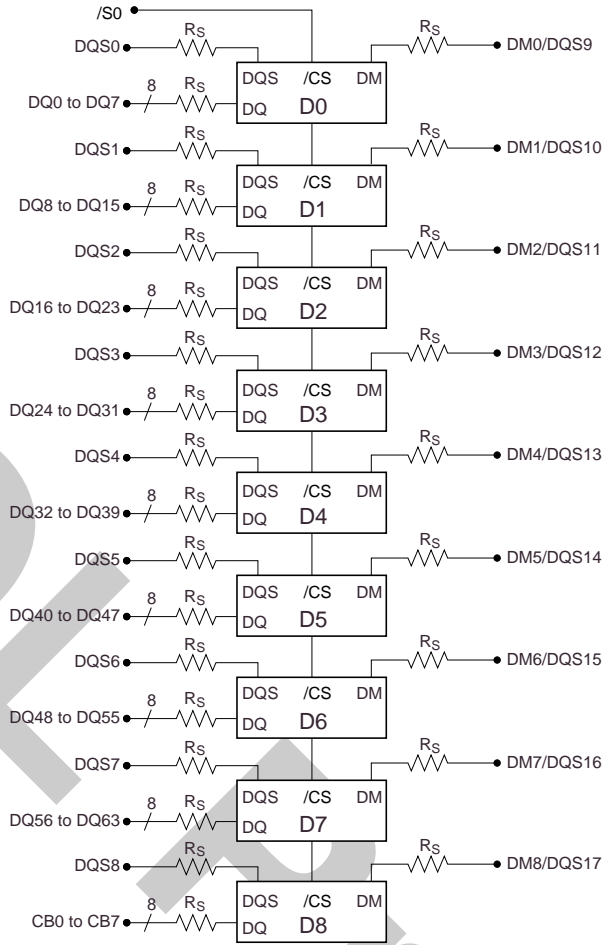

* D0 to D8: HM5425801
 U0: 2k bits EEPROM
 Rs: 22Ω

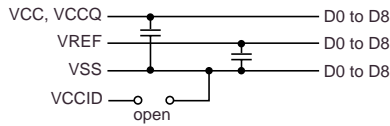

Clock wiring

Clock input	DDR SDRAMs
CK0/ /CK0	3DRAM loads
CK1/ /CK1	3DRAM loads
CK2/ /CK2	3DRAM loads

Note: Wire per Clock loading table/Wiring diagrams.

- A0 to A12 → A0 to A12 (D0 to D8)
- BA0, BA1 → BA0, BA1 (D0 to D8)
- /RAS → /RAS (D0 to D8)
- /CAS → /CAS (D0 to D8)
- /WE → /WE (D0 to D8)
- CKE0 → CKE (D0 to D8)

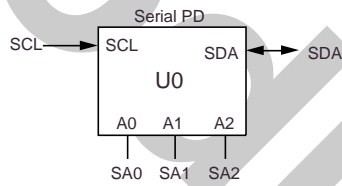

Notes:

1. The SDA pull-up resistor is required due to the open-drain/open-collector output.
2. The SCL pull-up resistor is recommended because of the normal SCL line inactive "high" state.

Logical Clock Net Structure

6DRAM loads

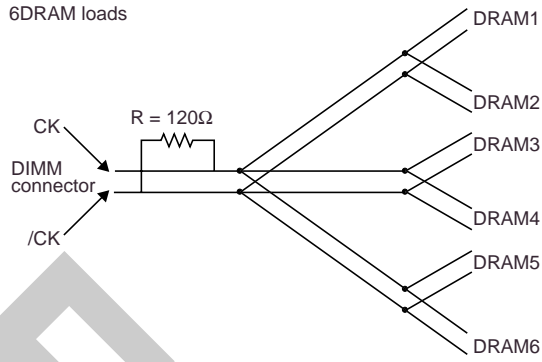

5DRAM loads

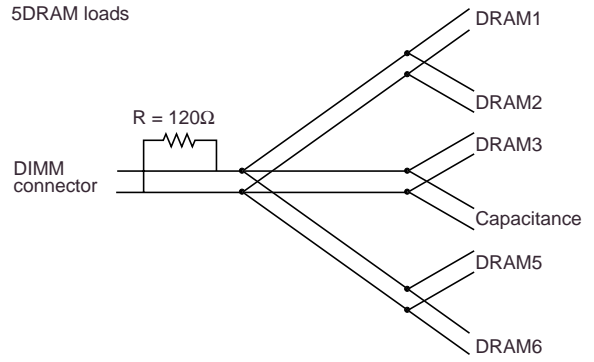

4DRAM loads

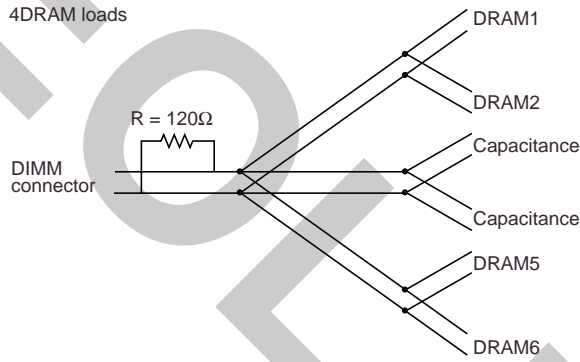

3DRAM loads

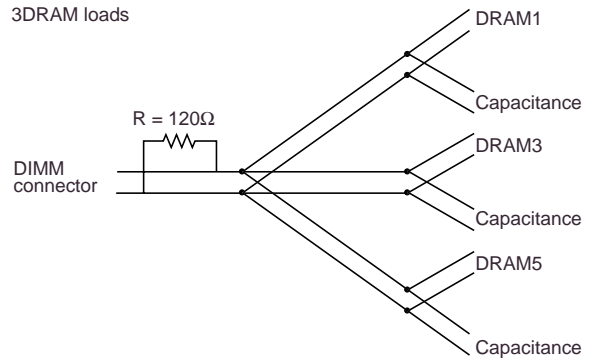

2DRAM loads

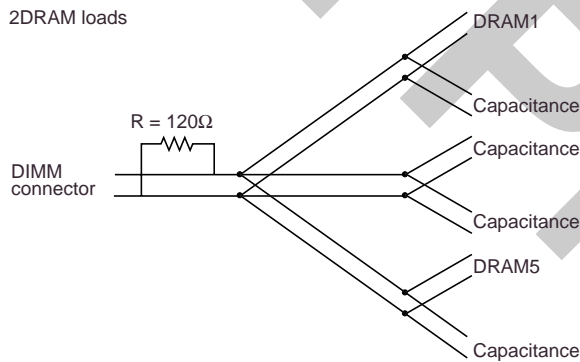

1DRAM loads

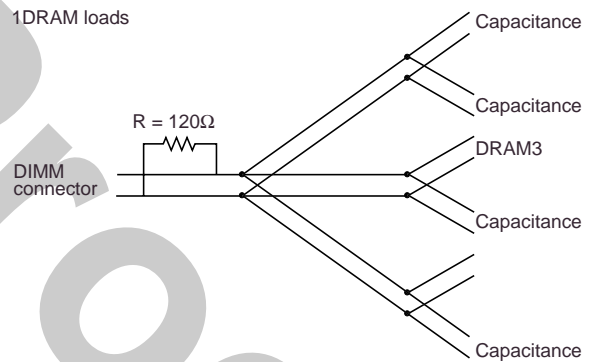

Pin Functions (1)

CK (CLK), /CK (/CLK) (input pin): The CK and the /CK are the master clock inputs. All inputs except DMs, DQs and DQs are referred to the cross point of the CK rising edge and the VREF level. When a read operation, DQs and DQs are referred to the cross point of the CK and the /CK. When a write operation, DMs and DQs are referred to the cross point of the DQS and the VREF level. DQs for write operation are referred to the cross point of the CK and the /CK.

/S (/CS) (input pin): When /S is Low, commands and data can be input. When /S is High, all inputs are ignored. However, internal operations (bank active, burst operations, etc.) are held.

/RAS, /CAS, and /WE (input pins): These pins define operating commands (read, write, etc.) depending on the combinations of their voltage levels. See "Command operation".

A0 to A12 (input pins): Row address (AX0 to AX12) is determined by the A0 to the A12 level at the cross point of the CK rising edge and the VREF level in a bank active command cycle. Column address (AY0 to AY9) is loaded via the A0 to the A9 at the cross point of the CK rising edge and the VREF level in a read or a write command cycle. This column address becomes the starting address of a burst operation.

A10 (AP) (input pin): A10 defines the precharge mode when a precharge command, a read command or a write command is issued. If A10 = High when a precharge command is issued, all banks are precharged. If A10 = Low when a precharge command is issued, only the bank that is selected by BA1, BA0 is precharged. If A10 = High when read or write command, auto-precharge function is enabled. While A10 = Low, auto-precharge function is disabled.

BA0, BA1 (input pin): BA0/BA1 are bank select signals. The memory array is divided into bank 0, bank 1, bank 2 and bank 3. If BA1 = Low and BA0 = Low, bank 0 is selected. If BA1 = High and BA0 = Low, bank 1 is selected. If BA1 = Low and BA0 = High, bank 2 is selected. If BA1 = High and BA0 = High, bank 3 is selected.

CKE (input pin): CKE controls power down and self-refresh. The power down and the self-refresh commands are entered when the CKE is driven Low and exited when it resumes to High.

The CKE level must be kept for 1 CK cycle (= LCKEPW) at least, that is, if CKE changes at the cross point of the CK rising edge and the VREF level with proper setup time t_{1S}, at the next CK rising edge CKE level must be kept with proper hold time t_{1H}.

Pin Functions (2)

DQ, CB (input and output pins): Data are input to and output from these pins.

DQS (input and output pin): DQS provide the read data strobes (as output) and the write data strobes (as input).

DM (input pins): DM is the reference signal of the data input mask function. DMs are sampled at the cross point of DQS and VREF

VCC and VCCQ (power supply pins): 2.5V is applied. (VCC is for the internal circuit and VCCQ is for the output buffer.)

VCCSPD (power supply pin): 2.5V is applied (For serial EEPROM).

VSS (power supply pin): Ground is connected.

Detailed Operation Part, AC Characteristics and Timing Waveforms

Refer to the HM5425161B/HM5425801B/HM5425401B Series datasheet (E0086H10).

Electrical Specifications

Absolute Maximum Ratings

Parameter	Symbol	Value	Unit	Note
Voltage on any pin relative to VSS	VT	-1.0 to +4.6	V	1
Supply voltage relative to VSS	VCC, VCCQ	-1.0 to +4.6	V	1
Short circuit output current	IOUT	50	mA	
Power dissipation HB54A2568FM	PT	8	W	
HB54A2569FM	PT	9	W	
Operating temperature	Topr	0 to +55	°C	
Storage temperature	Tstg	-50 to +100	°C	

Notes: 1. Respect to VSS.

DC Operating Conditions (TA = 0 to +55°C)

Parameter	Symbol	min.	Typ	max.	Unit	Notes
Supply voltage	VCC, VCCQ	2.3	2.5	2.7	V	1, 2
	VSS	0	0	0	V	
Input reference voltage	VREF	1.15	1.25	1.35	V	1
Termination voltage	VTT	VREF - 0.04	VREF	VREF + 0.04	V	1
DC Input high voltage	VIH	VREF + 0.18	—	VCCQ + 0.3	V	1, 3
DC Input low voltage	VIL	-0.3	—	VREF - 0.18	V	1, 4
DC Input signal voltage	VIN (dc)	-0.3	—	VCCQ + 0.3	V	5
DC differential input voltage	VSWING (dc)	0.36	—	VCCQ + 0.6	V	6

Notes: 1. All parameters are referred to VSS, when measured.

2. VCCQ must be lower than or equal to VCC.
3. VIH is allowed to exceed VCC up to 4.6V for the period shorter than or equal to 5ns.
4. VIL is allowed to outreach below VSS down to -1.0V for the period shorter than or equal to 5ns.
5. VIN (dc) specifies the allowable dc execution of each differential input.
6. VSWING (dc) specifies the input differential voltage required for switching.

DC Characteristics 1 (TA = 0 to 55°C, VCC, VCCQ = 2.5V ± 0.2V, VSS = 0V)

Parameter	Symbol	Grade	× 64	× 72	Unit	Test condition	Notes
			max.	max.			
Operating current (ACTV-PRE)	ICC0	-A75B	800	900	mA	CKE ≥ VIH, tRC = min.	1, 2, 5
		-B75B	760	855			
		-10B	640	720			
Operating current (ACTV-READ-PRE)	ICC1	-A75B	1240	1395	mA	CKE ≥ VIH, BL = 2, CL = 2.5, tRC = min.	1, 2, 5
		-B75B	1160	1305			
		-10B	1040	1170			
Idle power down standby current	ICC2P	-A75B	144	162	mA	CKE ≤ VIL	4
		-B75B	120	135			
		-10B	96	108			
Idle standby current	ICC2N	-A75B	320	360	mA	CKE ≥ VIH, /CS ≥ VIH	4
		-B75B	280	315			
		-10B	240	270			
Active power down standby current	ICC3P	-A75B	200	225	mA	CKE ≤ VIL	3
		-B75B	160	180			
		-10B	120	135			
Active standby current	ICC3N	-A75B	400	450	mA	CKE ≥ VIH, /CS ≥ VIH, tRAS = max.	3
		-B75B	360	405			
		-10B	320	360			
Operating current (Burst read operation)	ICC4R	-A75B	1800	2025	mA	CKE ≥ VIH, BL = 2, CL = 2.5	1, 2, 5, 6
		-B75B	1720	1935			
		-10B	1640	1845			
Operating current (Burst write operation)	ICC4W	-A75B	1640	1845	mA	CKE ≥ VIH, BL = 2, CL = 2.5	1, 2, 5, 6
		-B75B	1560	1755			
		-10B	1480	1665			
Auto refresh current	ICC5	-A75B	1640	1845	mA	tRFC = min., Input ≤ VIL or ≥ VIH	
		-B75B	1600	1800			
		-10B	1440	1620			
Self refresh current	ICC6		24	27	mA	Input ≥ VCC – 0.2V Input ≤ 0.2V.	

Notes. 1. These ICC data are measured under condition that DQ pins are not connected.

2. One bank operation.
3. One bank active.
4. All banks idle.
5. Command/Address transition once per one cycle.
6. Data/Data mask transition twice per one cycle.
7. The ICC data on this table are measured with regard to tCK = min. in general.

DC Characteristics2 (TA = 0 to 55°C, VCC, VCCQ = 2.5V ± 0.2V, VSS = 0V)

Parameter	Symbol	min.	max.	Unit	Test condition	Notes
Input leakage current	ILI	-10	10	μA	VCC ≥ VIN ≥ VSS	
Output leakage current	ILO	-10	10	μA	VCC ≥ VOUT ≥ VSS	
Output high voltage	VOH	VTT + 0.76	—	V	IOH (max.) = -15.2mA	
Output low voltage	VOL	—	VTT - 0.76	V	IOL (min.) = 15.2mA	

Pin Capacitance (TA = 25°C, VCC, VCCQ = 2.5V ± 0.2V)

[HB54A2568FM]

Parameter	Symbol	Pins	min.	max.	Unit	Notes
Input capacitance	CI1	Address, Cont.	—	85	pF	1
Input capacitance	CI2	CKE, /S	—	75	pF	1
Input capacitance	CI3	CK, /CK	—	65		
Data and DQS input/output capacitance	CO	DQ, DQS	—	15	pF	1, 2

[HB54A2569FM]

Parameter	Symbol	Pins	min.	max.	Unit	Notes
Input capacitance	CI1	Address, Cont.	—	92	pF	1
Input capacitance	CI2	CKE, /S	—	82	pF	1
Input capacitance	CI3	CK, /CK	—	65		
Data and DQS input/output capacitance	CO	DQ, DQS, CB	—	15	pF	1, 2

- Notes: 1. These parameters are measured on conditions: f = 100MHz, VOUT = VCCQ/2, ΔVOUT = 0.2V.
 2. Dout circuits are disabled.

Timing Parameter Measured in Clock Cycle for Unbuffered DIMM

Parameter	Symbol	Number of clock cycle	
		min.	max.
Write to pre-charge command delay (same bank)	tWPD	3 + BL/2	
Read to pre-charge command delay (same bank)	tRPD	BL/2	
Write to read command delay (to input all data)	tWRD	2 + BL/2	
Burst stop command to write command delay (CL = 2)	tBSTW	2	
(CL = 2.5)	tBSTW	3	
Burst stop command to DQ High-Z (CL = 2)	tBSTZ	2	
(CL = 2.5)	tBSTZ	2.5	
Read command to write command delay (to output all data) (CL = 2)	tRWD	2 + BL/2	
(CL = 2.5)	tRWD	3 + BL/2	
Pre-charge command to High-Z (CL = 2)	tHZIP	2	
(CL = 2.5)	tHZIP	2.5	
Write command to data in latency	tWCD	1	
Write recovery	tWR	2	
DM to data in latency	tDMD	0	
Register set command to active or register set command	tMRD	2	
Self refresh exit to non-read command	tSNR	10	
Self refresh exit to read command	tSRD	200	
Power down entry	tPDEN		1
Power down exit to command input	tPDEX		1
CKE minimum pulse width	tCKEPW	1	

Physical Outline

Unit: mm

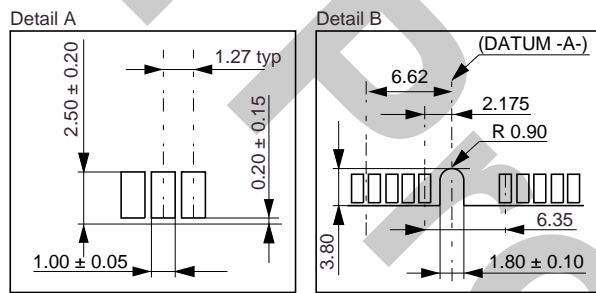
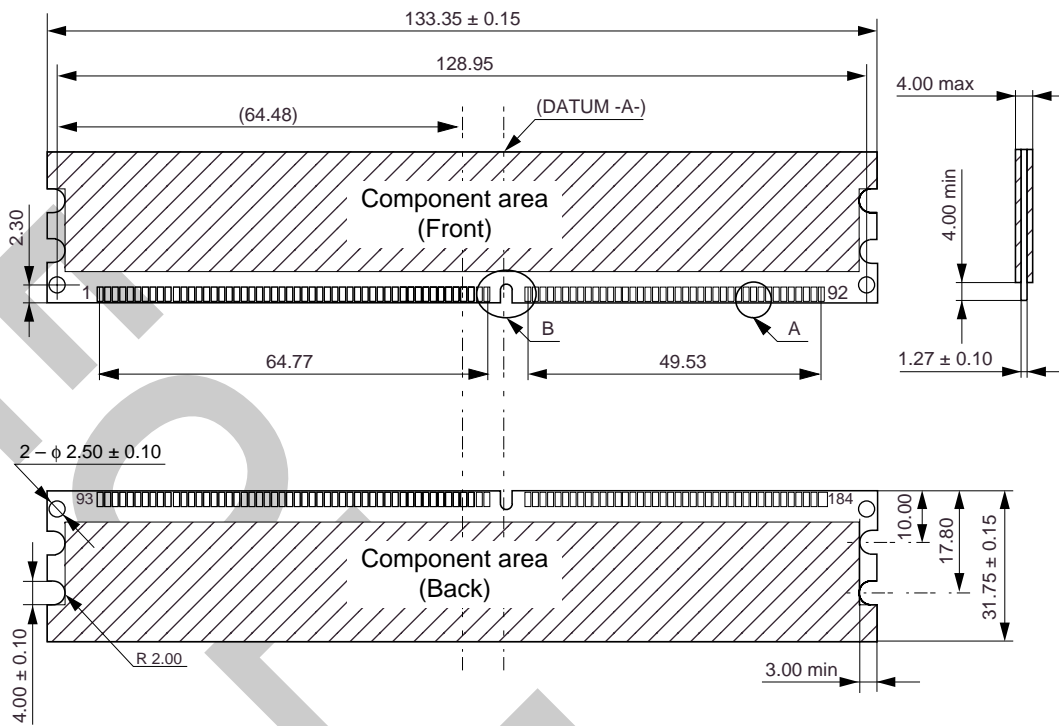

Note: Tolerance on all dimensions ± 0.13 unless otherwise specified.

ECA-TS2-0040-01

CAUTION FOR HANDLING MEMORY MODULES

When handling or inserting memory modules, be sure not to touch any components on the modules, such as the memory ICs, chip capacitors and chip resistors. It is necessary to avoid undue mechanical stress on these components to prevent damaging them.

In particular, do not push module cover or drop the modules in order to protect from mechanical defects, which would be electrical defects.

When re-packing memory modules, be sure the modules are not touching each other.

Modules in contact with other modules may cause excessive mechanical stress, which may damage the modules.

MDE0202

NOTES FOR CMOS DEVICES**① PRECAUTION AGAINST ESD FOR MOS DEVICES**

Exposing the MOS devices to a strong electric field can cause destruction of the gate oxide and ultimately degrade the MOS devices operation. Steps must be taken to stop generation of static electricity as much as possible, and quickly dissipate it, when once it has occurred. Environmental control must be adequate. When it is dry, humidifier should be used. It is recommended to avoid using insulators that easily build static electricity. MOS devices must be stored and transported in an anti-static container, static shielding bag or conductive material. All test and measurement tools including work bench and floor should be grounded. The operator should be grounded using wrist strap. MOS devices must not be touched with bare hands. Similar precautions need to be taken for PW boards with semiconductor MOS devices on it.

② HANDLING OF UNUSED INPUT PINS FOR CMOS DEVICES

No connection for CMOS devices input pins can be a cause of malfunction. If no connection is provided to the input pins, it is possible that an internal input level may be generated due to noise, etc., hence causing malfunction. CMOS devices behave differently than Bipolar or NMOS devices. Input levels of CMOS devices must be fixed high or low by using a pull-up or pull-down circuitry. Each unused pin should be connected to V_{DD} or GND with a resistor, if it is considered to have a possibility of being an output pin. The unused pins must be handled in accordance with the related specifications.

③ STATUS BEFORE INITIALIZATION OF MOS DEVICES

Power-on does not necessarily define initial status of MOS devices. Production process of MOS does not define the initial operation status of the device. Immediately after the power source is turned ON, the MOS devices with reset function have not yet been initialized. Hence, power-on does not guarantee output pin levels, I/O settings or contents of registers. MOS devices are not initialized until the reset signal is received. Reset operation must be executed immediately after power-on for MOS devices having reset function.

CME0107

The information in this document is subject to change without notice. Before using this document, confirm that this is the latest version.

No part of this document may be copied or reproduced in any form or by any means without the prior written consent of Elpida Memory, Inc.

Elpida Memory, Inc. does not assume any liability for infringement of any intellectual property rights (including but not limited to patents, copyrights, and circuit layout licenses) of Elpida Memory, Inc. or third parties by or arising from the use of the products or information listed in this document. No license, express, implied or otherwise, is granted under any patents, copyrights or other intellectual property rights of Elpida Memory, Inc. or others.

Descriptions of circuits, software and other related information in this document are provided for illustrative purposes in semiconductor product operation and application examples. The incorporation of these circuits, software and information in the design of the customer's equipment shall be done under the full responsibility of the customer. Elpida Memory, Inc. assumes no responsibility for any losses incurred by customers or third parties arising from the use of these circuits, software and information.

[Product applications]

Elpida Memory, Inc. makes every attempt to ensure that its products are of high quality and reliability. However, users are instructed to contact Elpida Memory's sales office before using the product in aerospace, aeronautics, nuclear power, combustion control, transportation, traffic, safety equipment, medical equipment for life support, or other such application in which especially high quality and reliability is demanded or where its failure or malfunction may directly threaten human life or cause risk of bodily injury.

[Product usage]

Design your application so that the product is used within the ranges and conditions guaranteed by Elpida Memory, Inc., including the maximum ratings, operating supply voltage range, heat radiation characteristics, installation conditions and other related characteristics. Elpida Memory, Inc. bears no responsibility for failure or damage when the product is used beyond the guaranteed ranges and conditions. Even within the guaranteed ranges and conditions, consider normally foreseeable failure rates or failure modes in semiconductor devices and employ systemic measures such as fail-safes, so that the equipment incorporating Elpida Memory, Inc. products does not cause bodily injury, fire or other consequential damage due to the operation of the Elpida Memory, Inc. product.

[Usage environment]

This product is not designed to be resistant to electromagnetic waves or radiation. This product must be used in a non-condensing environment.

If you export the products or technology described in this document that are controlled by the Foreign Exchange and Foreign Trade Law of Japan, you must follow the necessary procedures in accordance with the relevant laws and regulations of Japan. Also, if you export products/technology controlled by U.S. export control regulations, or another country's export control laws or regulations, you must follow the necessary procedures in accordance with such laws or regulations.

If these products/technology are sold, leased, or transferred to a third party, or a third party is granted license to use these products, that third party must be made aware that they are responsible for compliance with the relevant laws and regulations.

M01E0107