



Product Description

RFMD's SGC-6289Z is a high performance SiGe HBT MMIC amplifier utilizing a Darlington configuration with an active bias network. The active bias network provides stable current over temperature and process Beta variations. Designed to run directly from a 5V supply, the SGC-6289Z does not require a dropping resistor as compared to traditional Darlington amplifiers. The SGC-6289Z product is designed for high linearity 5V gain block applications that require small size and minimal external components. It is internally matched to 50Ω.

Optimum Technology Matching® Applied

- GaAs HBT
- GaAs MESFET
- InGaP HBT
- SiGe BiCMOS
- Si BiCMOS
- SiGe HBT
- GaAs pHEMT
- Si CMOS
- Si BJT
- GaN HEMT
- InP HBT
- RF MEMS
- LDMOS

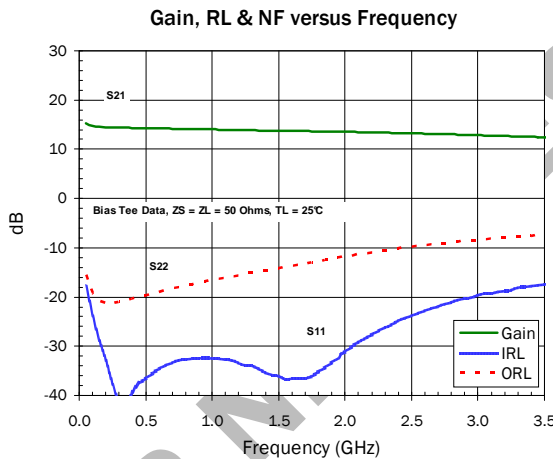

Features

- Single Supply Operation: 5V at $I_D = 83\text{mA}$
- No Dropping Resistor Required
- Patented Self Bias Circuitry
- Gain = 13.5dBm at 1950MHz
- P1dB = 19.2dBm at 1950MHz
- IP3 = 33.5dBm at 1950MHz
- Robust 1000V ESD, Class 1C HBM

Applications

- PA Driver Amplifier
- Cellular, PCS, GSM, UMTS
- IF Amplifier
- Wireless Data, Satellite

Parameter	Specification			Unit	Condition
	Min.	Typ.	Max.		
Small Signal Gain		14.0		dB	500MHz
	12.5	14.0	15.5	dB	850MHz*
	12.0	13.5	15.0	dB	1950MHz
Output Power at 1dB Compression		19.0		dBm	500MHz
		19.5		dBm	850MHz
	17.7	19.2		dBm	1950MHz
Output Third Order Intercept Point		34.5		dBm	500MHz
		34.5		dBm	850MHz
	31.5	33.5		dBm	1950MHz
Input Return Loss	14.0	18.5		dB	1950MHz
Output Return Loss	20.0	25.5		dB	1950MHz
Noise Figure		3.3		dB	1930MHz
Device Operating Voltage		5		V	
Device Operating Current	70	83	96	mA	
Thermal Resistance		65		°C/W	junction to lead

Test Conditions: $V_D = 5.0\text{V}$, $I_D = 83\text{mA}$, $T_L = 25^\circ\text{C}$, OIP3 Tone Spacing = 1MHz, *Bias Tee Data, $Z_S = Z_L = 50\Omega$, P_{OUT} per tone = 0dBm, Application Circuit Data Unless Otherwise Noted

Absolute Maximum Ratings

Parameter	Rating	Unit
Max Device Current (I_D)	100	mA
Max Device Voltage (V_D)	7	V
Max RF Input Power* (See Note)	10	dBm
Max Junction Temperature (T_J)	+150	°C
Operating Temperature Range (T_L)	-40 to +85	°C
Max Storage Temperature	+150	°C
ESD Rating - Human Body Model (HBM)	Class 1C	
Moisture Sensitivity Level	MSL 2	

*Note: Load condition $Z_{L1} = 50\Omega$

*Note: $Z_{L2} = 10:1$ VSWR

Operation of this device beyond any one of these limits may cause permanent damage. For reliable continuous operation, the device voltage and current must not exceed the maximum operating values specified in the table on page one.

Bias Conditions should also satisfy the following expression:

$$I_D V_D < (T_J - T_L) / R_{TH, J - I} \text{ and } T_L = T_{LEAD}$$



Caution! ESD sensitive device.

Exceeding any one or a combination of the Absolute Maximum Rating conditions may cause permanent damage to the device. Extended application of Absolute Maximum Rating conditions to the device may reduce device reliability. Specified typical performance or functional operation of the device under Absolute Maximum Rating conditions is not implied.

The information in this publication is believed to be accurate and reliable. However, no responsibility is assumed by RF Micro Devices, Inc. ("RFMD") for its use, nor for any infringement of patents, or other rights of third parties, resulting from its use. No license is granted by implication or otherwise under any patent or patent rights of RFMD. RFMD reserves the right to change component circuitry, recommended application circuitry and specifications at any time without prior notice.



RFMD Green: RoHS compliant per EU Directive 2002/95/EC, halogen free per IEC 61249-2-21, < 1000ppm each of antimony trioxide in polymeric materials and red phosphorus as a flame retardant, and <2% antimony in solder.

Typical RF Performance at Key Operating Frequencies (Application Circuit data unless otherwise noted)

Parameter	Unit	100 MHz*	500 MHz	850 MHz	1950 MHz	2500 MHz	3500 MHz*
Small Signal Gain (G)	dB	15.0	14.0	14.0	13.5	13.2	12.5
Output Third Order Intercept Point (OIP_3)	dBm	35.5	34.5	34.5	33.5	31.5	28.5
Output Power at 1dB Compression (P_{1dB})	dBm	20.5	19.9	19.5	19.2	17.8	15.8
Input Return Loss (IRL)	dB	23.5	41.0	22.0	18.5	19.0	18.5
Output Return Loss (ORL)	dB	18.5	21.0	19.5	25.5	12.5	8.0
Reverse Isolation (S_{12})	dB	18.0	18.5	18.5	19.5	19.5	19.9
Noise Figure (NF)	dB	3.3	3.2	3.4	3.3	3.5	4.3

Test Conditions: $V_D = 5V$ $I_D = 83mA$ OIP_3 Tone Spacing = 1MHz, P_{OUT} per tone = 0dBm $T_L = 25^\circ C$ $Z_S = Z_L = 50\Omega$, *Bias Tee Data

Typical Performance with Bias Tees, $V_D = 5V$, $I_D = 83mA$

OIP3 versus Frequency (0 dBm tones)

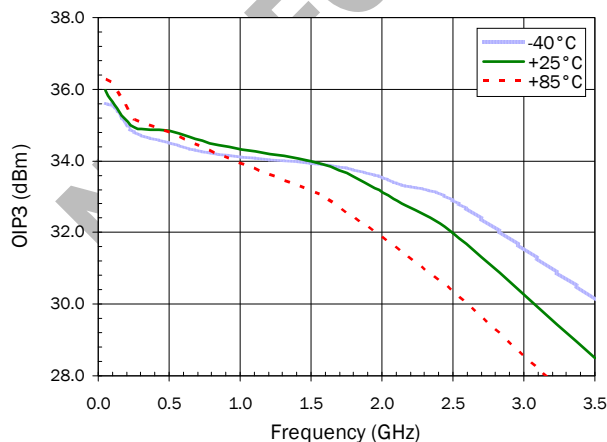

P1dB versus Frequency

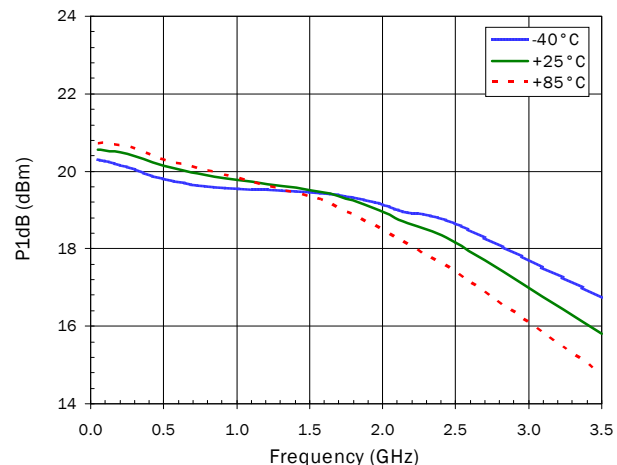

Typical Performance with Bias Tees, $V_D = 5V$, $I_D = 83mA$

Noise Figure versus Frequency

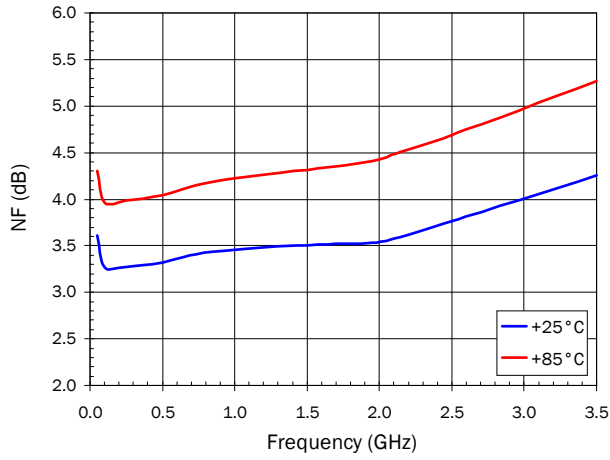

DCIV

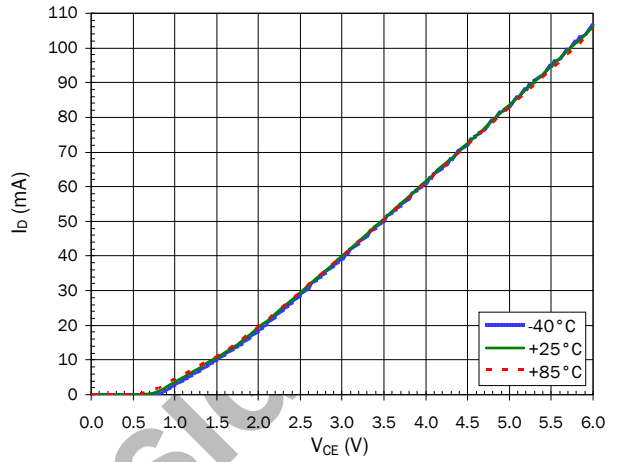

S11 versus Frequency

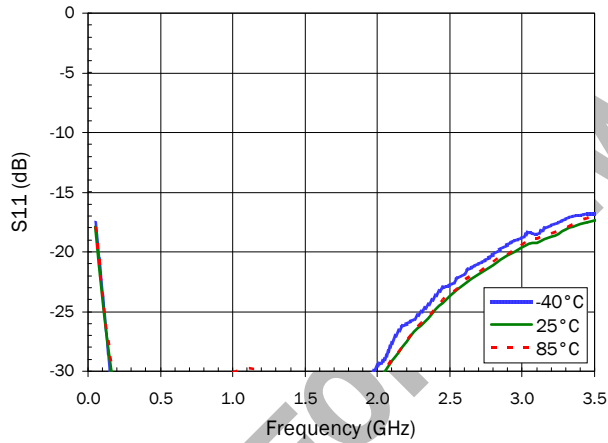

S21 versus Frequency

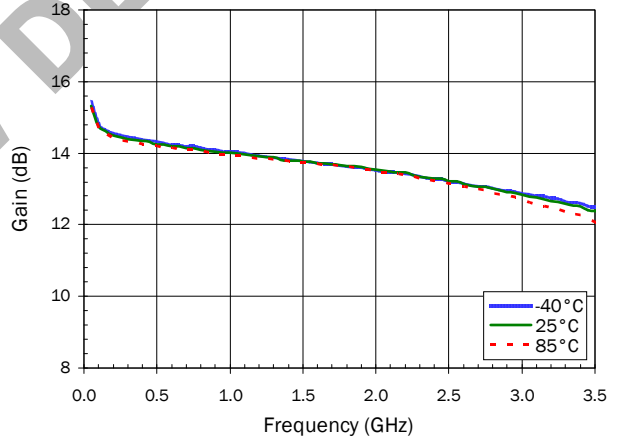

S12 versus Frequency

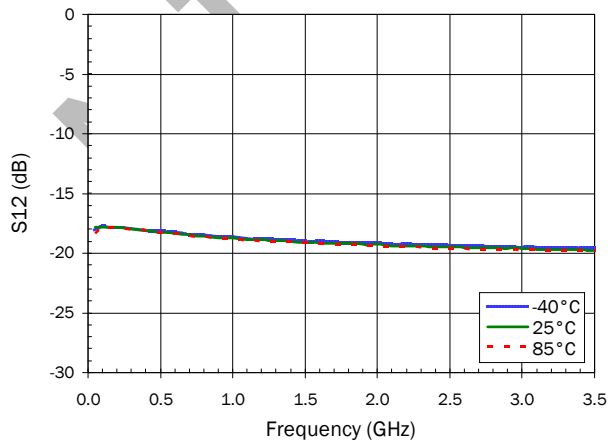

S22 versus Frequency

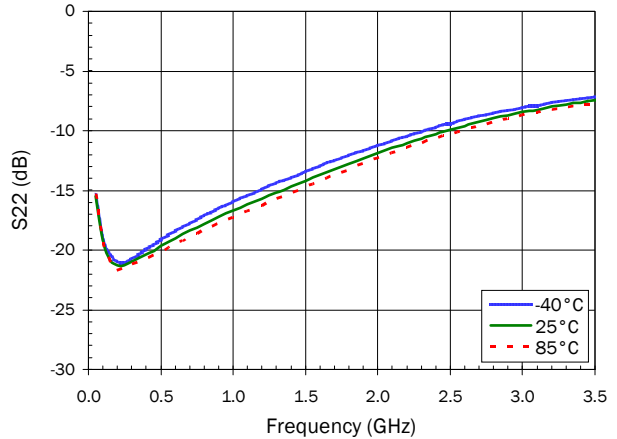

Typical Performance with Application Circuit, $V_D = 5V$, $I_D = 83mA$

OIP3 versus Frequency (0dBm tones)

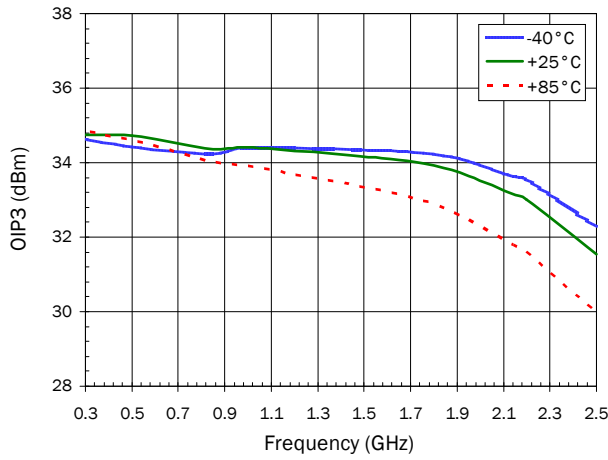

P1dB versus Frequency

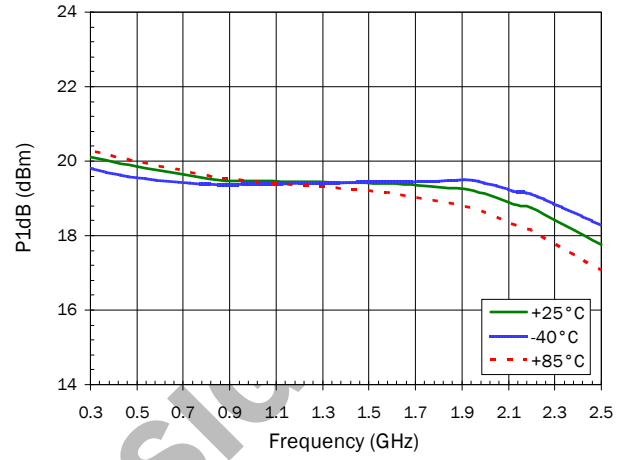

P_{OUT} versus P_{IN} @ 850MHz

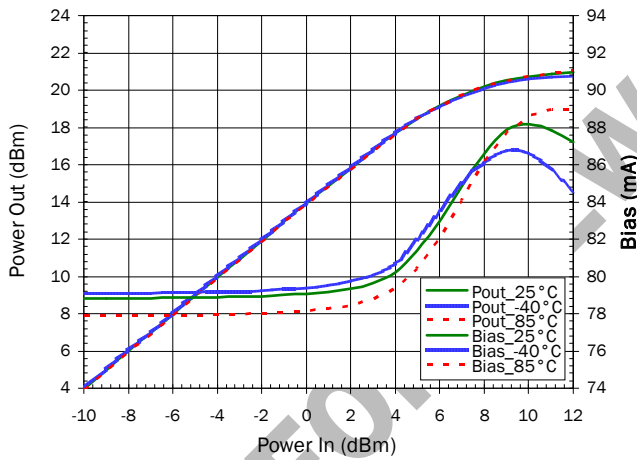

P_{OUT} versus P_{IN} @ 2140 MHz

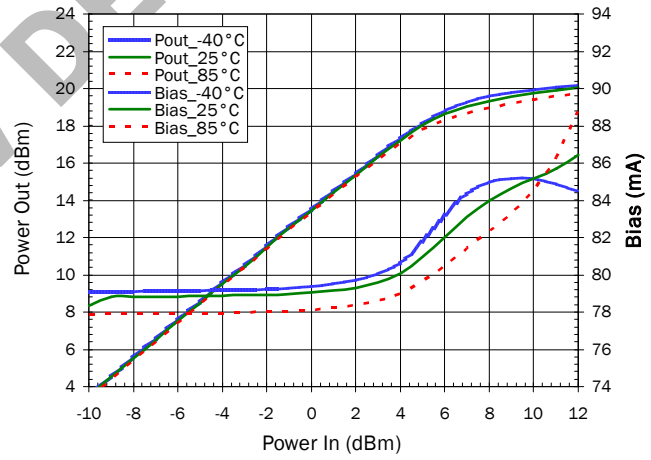

Noise Figure versus Frequency

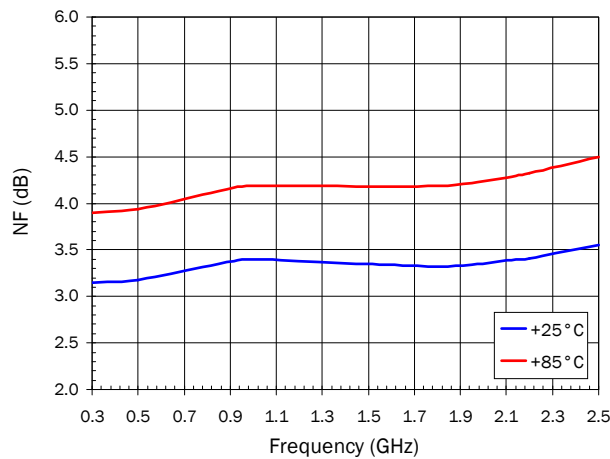

Typical Performance with Application Circuit, $V_D = 5V$, $I_D = 83mA$

S11 versus Frequency

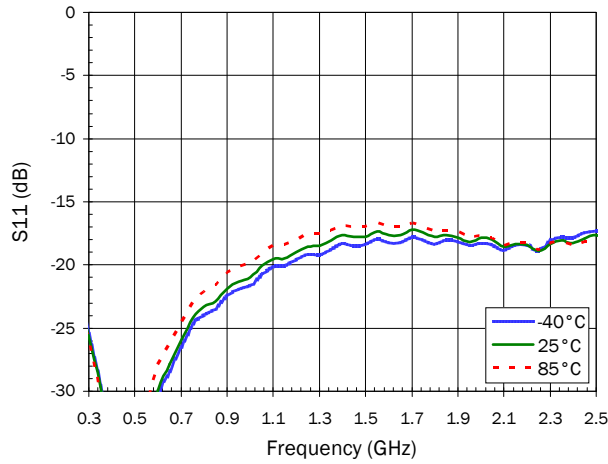

S21 versus Frequency

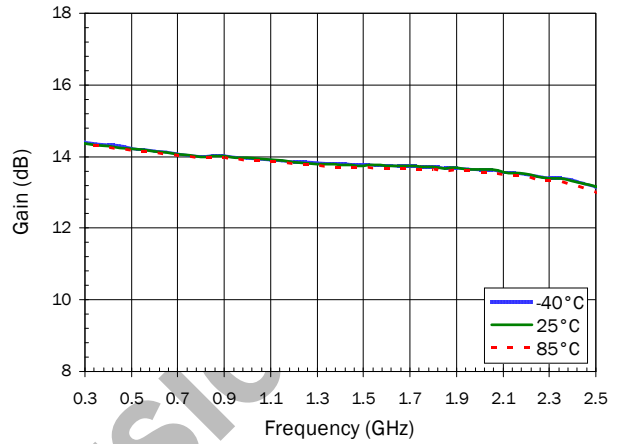

S12 versus Frequency

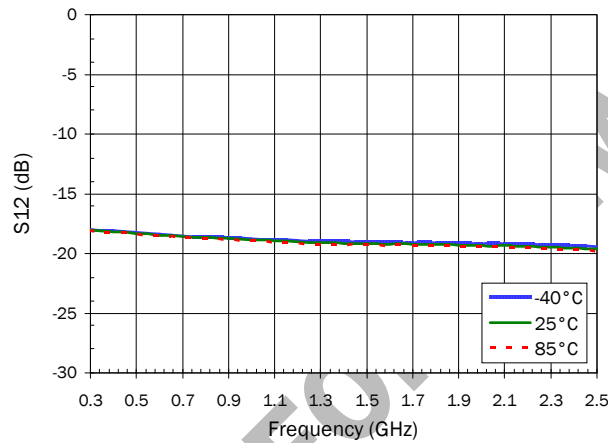

S22 versus Frequency

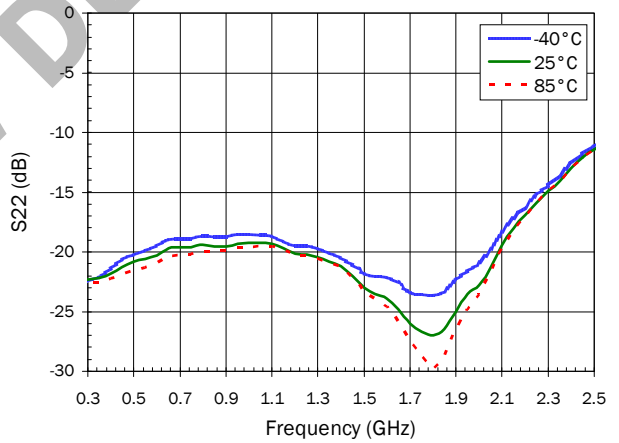

NOT FOR PRODUCTION DESIGN

Pin	Function	Description
1	RF IN	RF input pin. This pin requires the use of an external DC blocking capacitor chosen for the frequency of operation.
2, 4	GND	Connection to ground. Use via holes as close to the device ground leads as possible to reduce ground inductance and achieve optimum RF performance.
3	RF OUT/ DC BIAS	RF output and bias pin. This pin requires the use of an external DC blocking capacitor chosen for the frequency of operation.

Suggested PCB Pad Layout

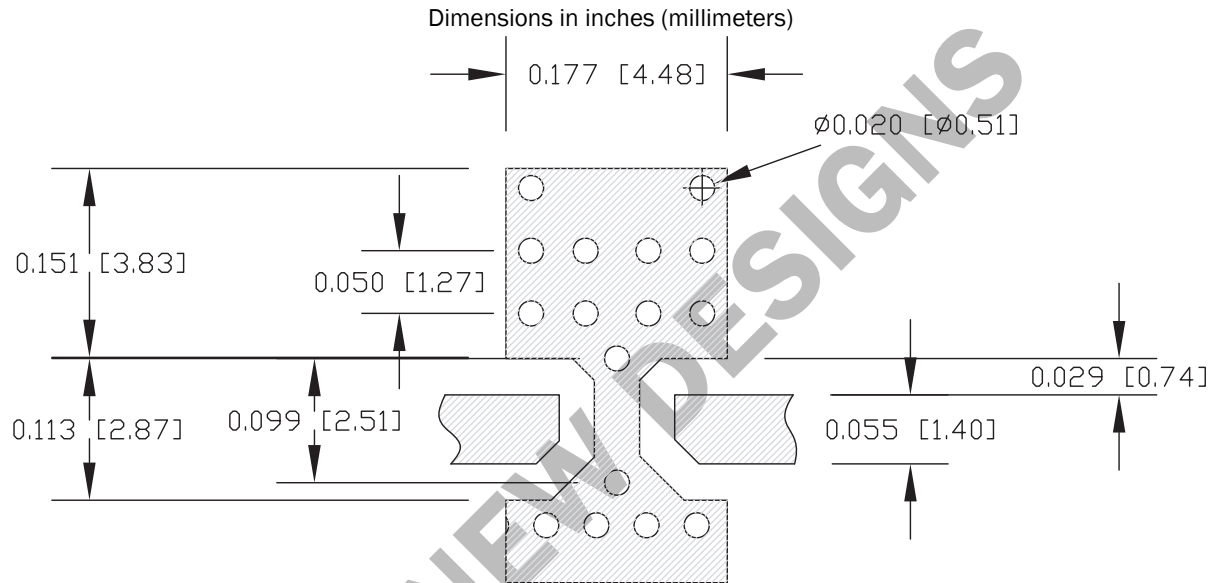

Package Drawing

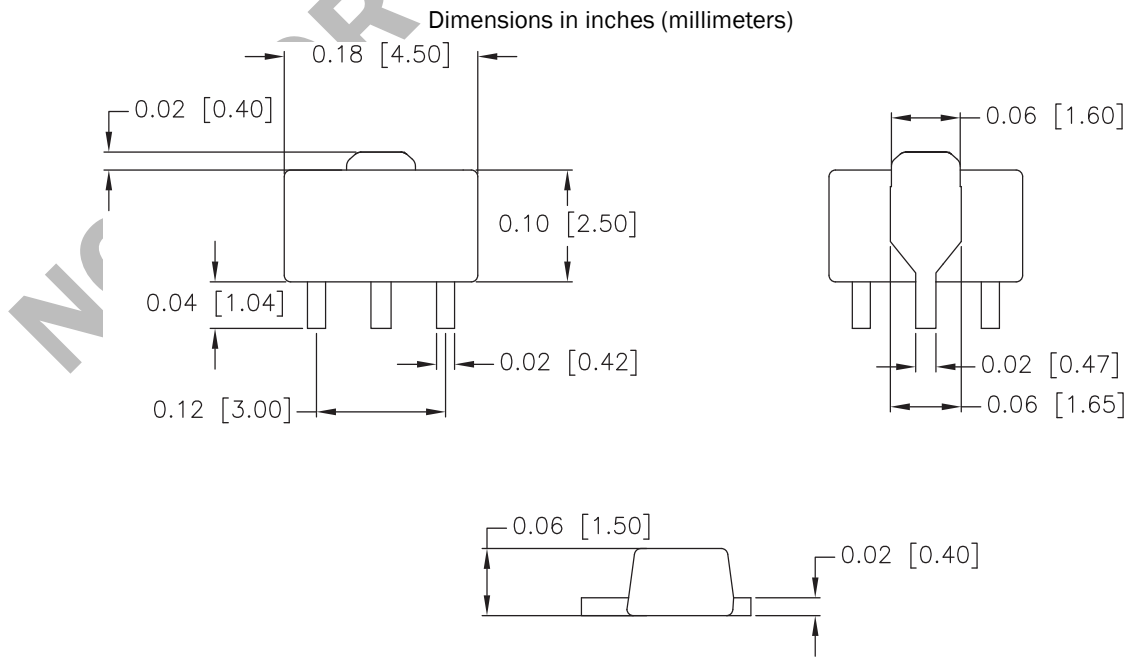

Application Schematic

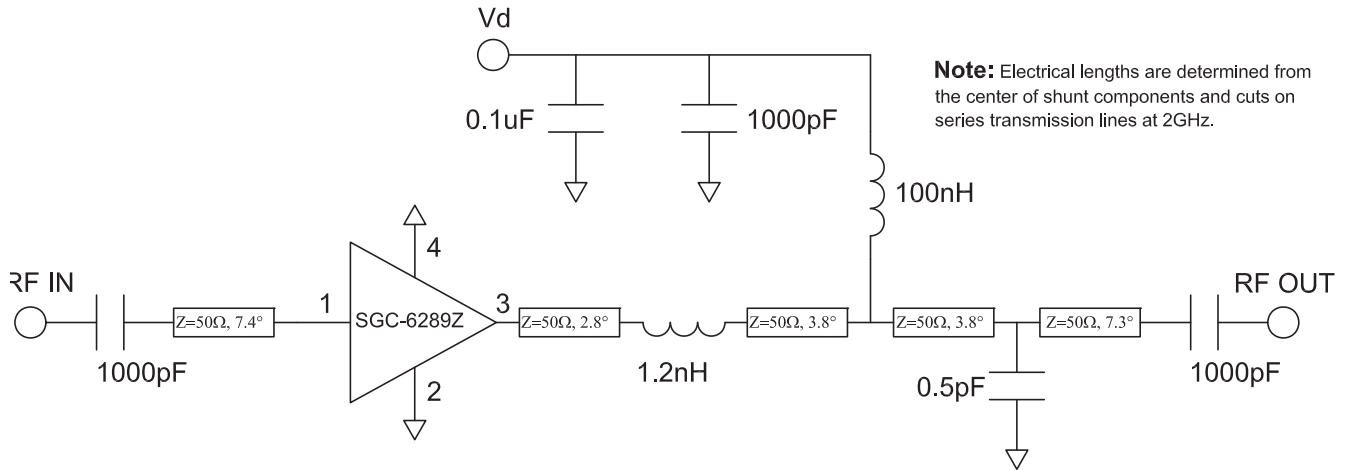

Note: Electrical lengths are determined from the center of shunt components and cuts on series transmission lines at 2GHz.

Evaluation Board

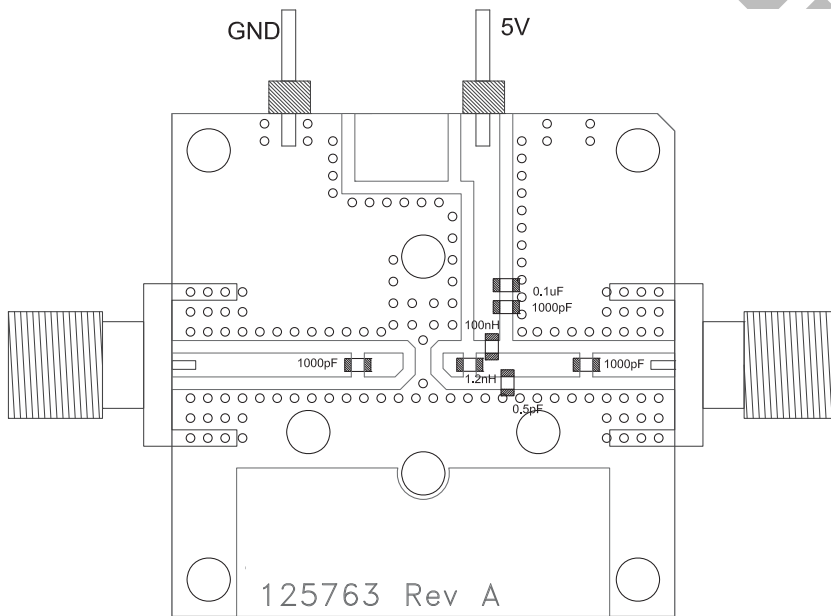

Mounting Instructions

1. Solder the copper pad on the backside of the device package to the ground plane.
2. Use a large ground pad area with many plated through-holes as shown.
3. We recommend 1 or 2 ounce copper. Measurements for this data sheet were made on a 31 mil thick FR-4 board with 1 ounce copper on both sides.

SGC-6289Z 200-2500 MHz

Part Identification

4



Part will be identified with "SGC6289Z" Trace Code. Alternate marking is "C62Z".

Ordering Information

Part Number	Description	Reel Size	Devices/Reel
SGC-6289Z	Lead Free, RoHS Compliant	13"	3000
SGC-6289Z-EVB1	200MHz to 2500MHz Eval Board	N/A	N/A