



RF Power Field Effect Transistors

N-Channel Enhancement-Mode Lateral MOSFETs

Designed for W-CDMA and LTE base station applications with frequencies from 2620- 2690 MHz. Can be used in Class AB and Class C for all typical cellular base station modulation formats.

- Typical Single-Carrier W-CDMA Performance: $V_{DD} = 28$ Volts, $I_{DQ} = 450$ mA, $P_{out} = 15.5$ Watts Avg., IQ Magnitude Clipping, Channel Bandwidth = 3.84 MHz, Input Signal PAR = 7.5 dB @ 0.01% Probability on CCDF.

Frequency	G_{ps} (dB)	η_D (%)	Output PAR (dB)	ACPR (dBc)
2620 MHz	16.3	33.2	6.3	-37.2
2655 MHz	16.3	33.0	6.3	-37.7
2690 MHz	16.3	32.9	6.2	-37.1

- Capable of Handling 10:1 VSWR, @ 32 Vdc, 2655 MHz, 78 Watts CW Output Power (3 dB Input Overdrive from Rated P_{out})
- Typical P_{out} @ 1 dB Compression Point = 60 Watts CW

Features

- 100% PAR Tested for Guaranteed Output Power Capability
- Characterized with Series Equivalent Large-Signal Impedance Parameters and Common Source S-Parameters
- Internally Matched for Ease of Use
- Integrated ESD Protection
- Greater Negative Gate-Source Voltage Range for Improved Class C Operation
- Designed for Digital Predistortion Error Correction Systems
- Optimized for Doherty Applications
- RoHS Compliant
- In Tape and Reel. R3 Suffix = 250 Units per 32 mm, 13 inch Reel.

MRF8S26060HR3
MRF8S26060HSR3

2620-2690 MHz, 15.5 W AVG., 28 V
W-CDMA, LTE
LATERAL N-CHANNEL
RF POWER MOSFETs

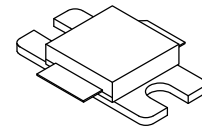

CASE 465I-02, STYLE 1
NI-400-240
MRF8S26060HR3

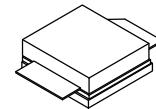

CASE 465J-02, STYLE 1
NI-400S-240
MRF8S26060HSR3

Table 1. Maximum Ratings

Rating	Symbol	Value	Unit
Drain-Source Voltage	V_{DSS}	-0.5, +65	Vdc
Gate-Source Voltage	V_{GS}	-6.0, +10	Vdc
Operating Voltage	V_{DD}	32, +0	Vdc
Storage Temperature Range	T_{stg}	-65 to +150	°C
Case Operating Temperature	T_C	150	°C
Operating Junction Temperature (1,2)	T_J	225	°C

Table 2. Thermal Characteristics

Characteristic	Symbol	Value (2,3)	Unit
Thermal Resistance, Junction to Case Case Temperature 76°C, 15.5 W CW, 28 Vdc, $I_{DQ} = 450$ mA, 2655 MHz Case Temperature 80°C, 60 W CW, 28 Vdc, $I_{DQ} = 450$ mA, 2655 MHz	$R_{\theta JC}$	1.0 0.90	°C/W

1. Continuous use at maximum temperature will affect MTTF.
2. MTTF calculator available at <http://www.freescale.com/rf>. Select Software & Tools/Development Tools/Calculators to access MTTF calculators by product.
3. Refer to AN1955, *Thermal Measurement Methodology of RF Power Amplifiers*. Go to <http://www.freescale.com/rf>. Select Documentation/Application Notes - AN1955.

Table 3. ESD Protection Characteristics

Test Methodology	Class
Human Body Model (per JESD22-A114)	2 (Minimum)
Machine Model (per EIA/JESD22-A115)	A (Minimum)
Charge Device Model (per JESD22-C101)	IV (Minimum)

Table 4. Electrical Characteristics ($T_A = 25^\circ\text{C}$ unless otherwise noted)

Characteristic	Symbol	Min	Typ	Max	Unit
Off Characteristics					
Zero Gate Voltage Drain Leakage Current ($V_{DS} = 65\text{ Vdc}$, $V_{GS} = 0\text{ Vdc}$)	I_{DSS}	—	—	10	μAdc
Zero Gate Voltage Drain Leakage Current ($V_{DS} = 28\text{ Vdc}$, $V_{GS} = 0\text{ Vdc}$)	I_{DSS}	—	—	1	μAdc
Gate-Source Leakage Current ($V_{GS} = 5\text{ Vdc}$, $V_{DS} = 0\text{ Vdc}$)	I_{GSS}	—	—	1	μAdc
On Characteristics					
Gate Threshold Voltage ($V_{DS} = 10\text{ Vdc}$, $I_D = 86\ \mu\text{Adc}$)	$V_{GS(th)}$	1.2	1.9	2.7	Vdc
Gate Quiescent Voltage ($V_{DD} = 28\text{ Vdc}$, $I_D = 450\text{ mAdc}$, Measured in Functional Test)	$V_{GS(Q)}$	2.0	2.7	3.5	Vdc
Drain-Source On-Voltage ($V_{GS} = 10\text{ Vdc}$, $I_D = 1\text{ Adc}$)	$V_{DS(on)}$	0.1	0.18	0.3	Vdc

Functional Tests ⁽¹⁾ (In Freescale Test Fixture, 50 ohm system) $V_{DD} = 28\text{ Vdc}$, $I_{DQ} = 450\text{ mA}$, $P_{out} = 15.5\text{ W Avg.}$, $f = 2690\text{ MHz}$, Single-Carrier W-CDMA, IQ Magnitude Clipping, Input Signal PAR = 7.5 dB @ 0.01% Probability on CCDF. ACPR measured in 3.84 MHz Channel Bandwidth @ $\pm 5\text{ MHz}$ Offset.

Power Gain	G_{ps}	15.0	16.3	18.0	dB
Drain Efficiency	η_D	30.0	32.9	—	%
Output Peak-to-Average Ratio @ 0.01% Probability on CCDF	PAR	5.8	6.2	—	dB
Adjacent Channel Power Ratio	ACPR	—	-37.1	-34.5	dBc
Input Return Loss	IRL	—	-16	-10	dB

Typical Broadband Performance (In Freescale Test Fixture, 50 ohm system) $V_{DD} = 28\text{ Vdc}$, $I_{DQ} = 450\text{ mA}$, $P_{out} = 15.5\text{ W Avg.}$, Single-Carrier W-CDMA, IQ Magnitude Clipping, Input Signal PAR = 7.5 dB @ 0.01% Probability on CCDF. ACPR measured in 3.84 MHz Channel Bandwidth @ $\pm 5\text{ MHz}$ Offset.

Frequency	G_{ps} (dB)	η_D (%)	Output PAR (dB)	ACPR (dBc)	IRL (dB)
2620 MHz	16.3	33.2	6.3	-37.2	-16
2655 MHz	16.3	33.0	6.3	-37.7	-17
2690 MHz	16.3	32.9	6.2	-37.1	-16

1. Part internally matched both on input and output.

(continued)

Table 4. Electrical Characteristics ($T_A = 25^\circ\text{C}$ unless otherwise noted) (continued)

Characteristic	Symbol	Min	Typ	Max	Unit
Typical Performances (In Freescale Test Fixture, 50 ohm system) $V_{DD} = 28\text{ Vdc}$, $I_{DQ} = 450\text{ mA}$, 2620-2690 MHz Bandwidth					
P_{out} @ 1 dB Compression Point, CW	P_{1dB}	—	60	—	W
IMD Symmetry @ 52 W PEP, P_{out} where IMD Third Order Intermodulation $\cong 30\text{ dBc}$ (Delta IMD Third Order Intermodulation between Upper and Lower Sidebands $> 2\text{ dB}$)	IMD_{sym}	—	16	—	MHz
VBW Resonance Point (IMD Third Order Intermodulation Inflection Point)	VBW_{res}	—	80	—	MHz
Gain Flatness in 70 MHz Bandwidth @ $P_{out} = 15.5\text{ W Avg.}$	G_F	—	0.2	—	dB
Gain Variation over Temperature (-30°C to $+85^\circ\text{C}$)	ΔG	—	0.014	—	dB/ $^\circ\text{C}$
Output Power Variation over Temperature (-30°C to $+85^\circ\text{C}$)	ΔP_{1dB}	—	0.006	—	dBm/ $^\circ\text{C}$

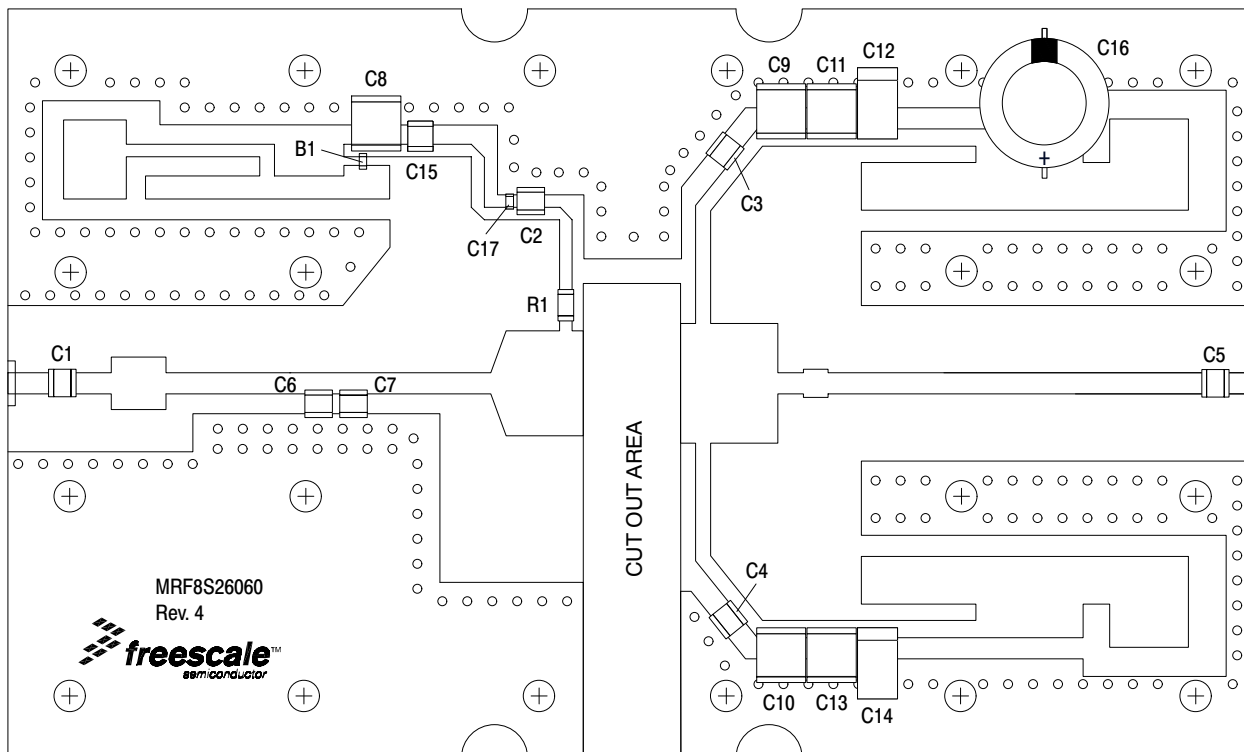

Figure 1. MRF8S26060HR3(HSR3) Test Circuit Component Layout

Table 5. MRF8S26060HR3(HSR3) Test Circuit Component Designations and Values

Part	Description	Part Number	Manufacturer
B1	RF Ferrite Bead	MPZ2012S300AT000	TDK
C1, C2, C3, C4, C5	5.6 pF Chip Capacitors	ATC100B5R6CT500XT	ATC
C6, C7	0.3 pF Chip Capacitors	ATC100B0R3BT500XT	ATC
C8, C9, C10	10 μ F, 50 V Chip Capacitors	C5750X7R1H106KT	TDK
C11, C13	22 μ F, 50 V Chip Capacitors	C5750JF1H226ZT	TDK
C12, C14	22 μ F, 35 V Tantalum Capacitors	T491X226K035AT	Kemet
C15	680 nF, 100 V Chip Capacitor	C3225X7R2A684KT	TDK
C16	220 μ F, 63 V Electrolytic Capacitor	MCGPR63V227M10X21	Multicomp
C17	1 nF, 250 V Chip Capacitor	C2012X7R2102KT	TDK
R1	12 Ω , 1/4 W Chip Resistor	CRCW120612R0FKEA	Vishay
PCB	0.030", $\epsilon_r = 2.55$	CuClad 25064-0300-55-22	Arlon

TYPICAL CHARACTERISTICS

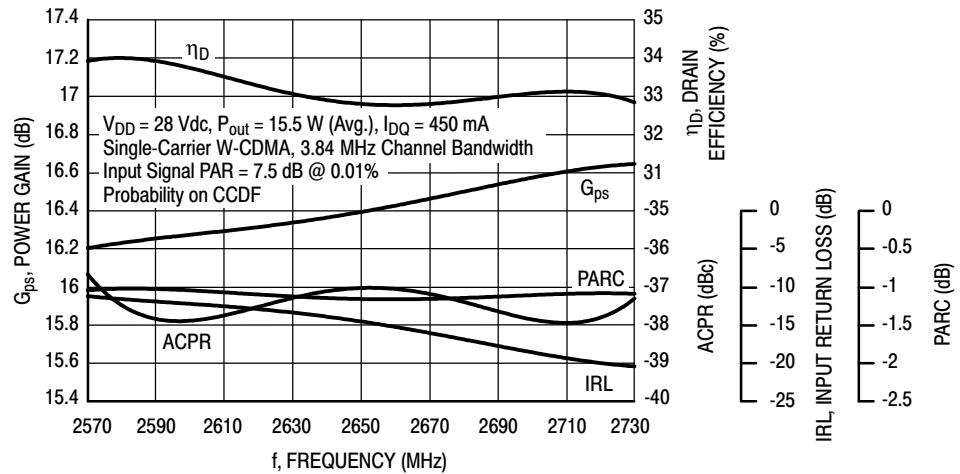

Figure 2. Output Peak-to-Average Ratio Compression (PARC) Broadband Performance @ $P_{out} = 15.5$ Watts Avg.

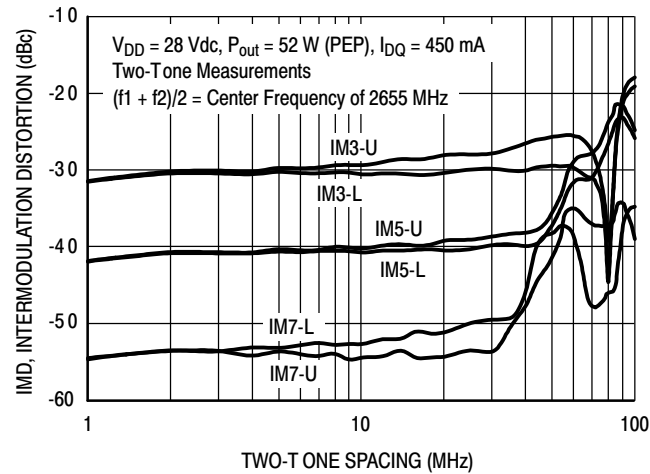

Figure 3. Intermodulation Distortion Products versus Two-Tone Spacing

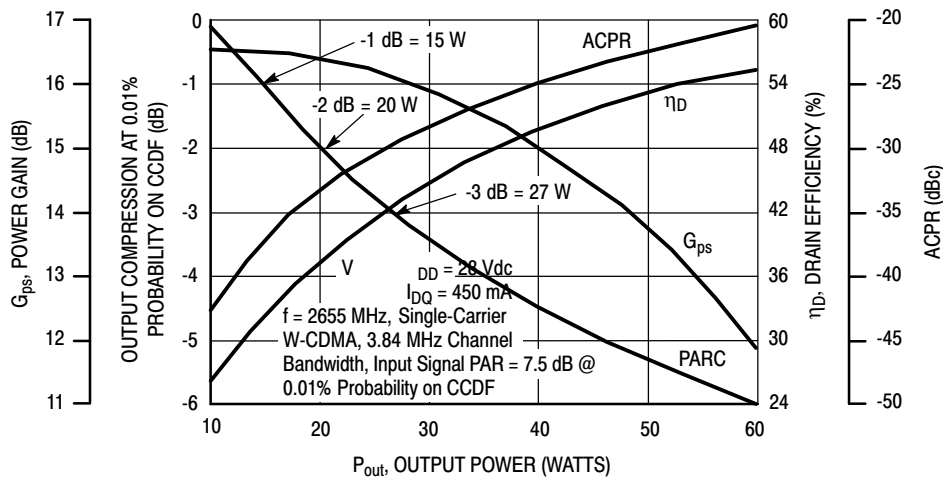

Figure 4. Output Peak-to-Average Ratio Compression (PARC) versus Output Power

TYPICAL CHARACTERISTICS

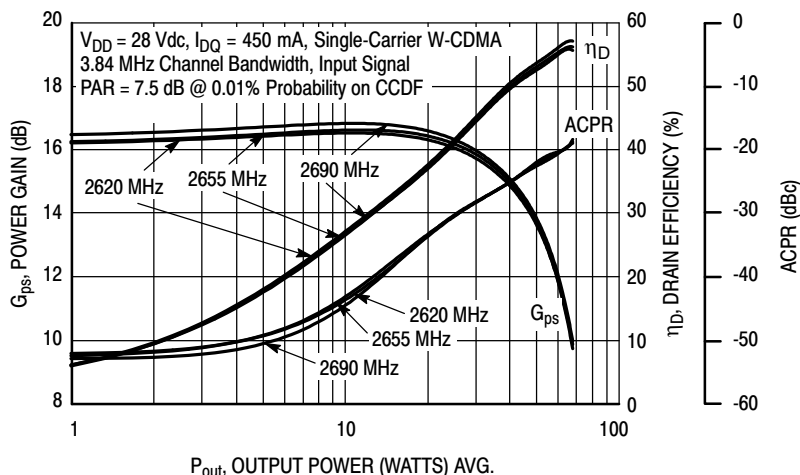

Figure 5. Single-Carrier W-CDMA Power Gain, Drain Efficiency and ACPR versus Output Power

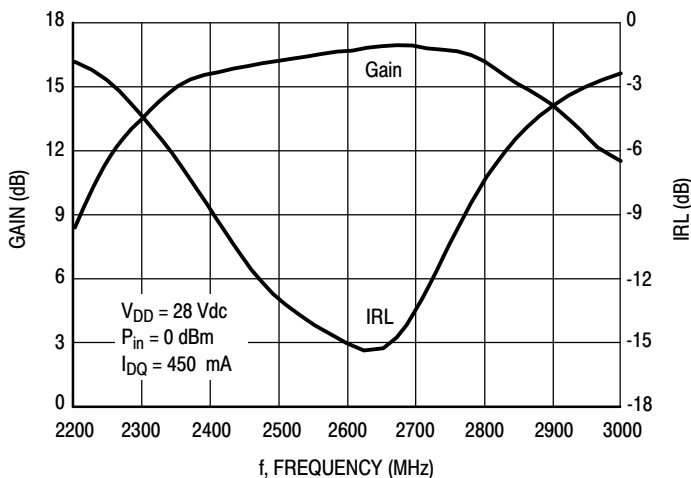

Figure 6. Broadband Frequency Response

W-CDMA TEST SIGNAL

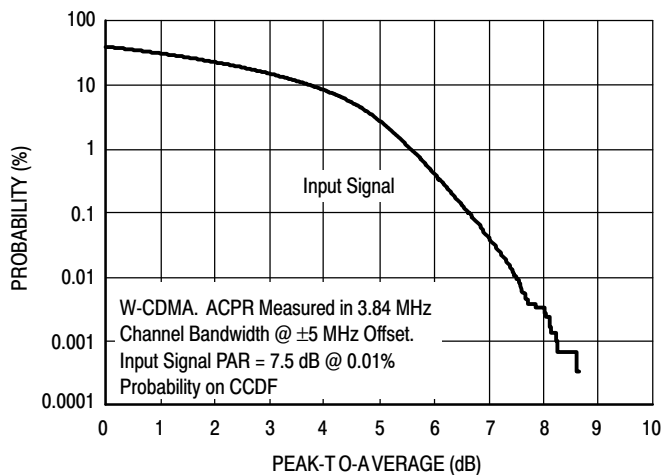

Figure 7. CCDF W-CDMA IQ Magnitude Clipping, Single-Carrier Test Signal

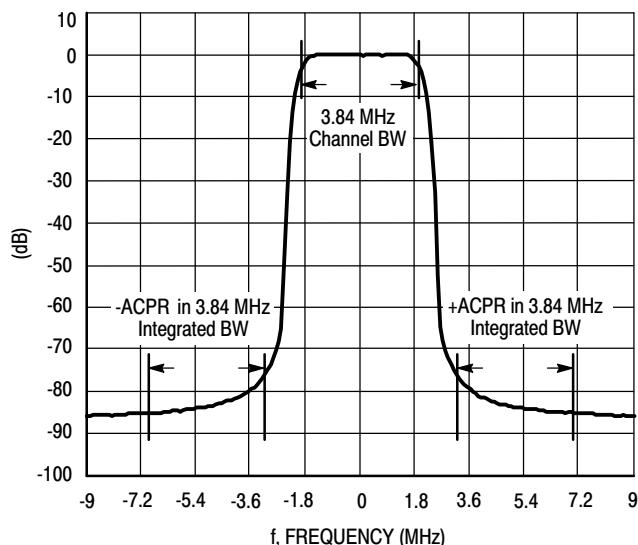

Figure 8. Single-Carrier W-CDMA Spectrum

$V_{DD} = 28 \text{ Vdc}$, $I_{DQ} = 450 \text{ mA}$, $P_{out} = 15.5 \text{ W Avg.}$

f MHz	Z_{source} Ω	Z_{load} Ω
2570	8.55 - j8.59	6.29 - j8.92
2590	8.68 - j8.39	6.27 - j8.73
2610	8.84 - j8.21	6.27 - j8.54
2630	8.99 - j8.07	6.26 - j8.37
2650	9.14 - j7.84	6.26 - j8.20
2670	9.37 - j7.70	6.24 - j8.06
2690	9.58 - j7.61	6.21 - j7.91
2710	9.80 - j7.53	6.17 - j7.78
2730	10.02 - j7.48	6.13 - j7.65

Z_{source} = Test circuit impedance as measured from gate to ground.

Z_{load} = Test circuit impedance as measured from drain to ground.

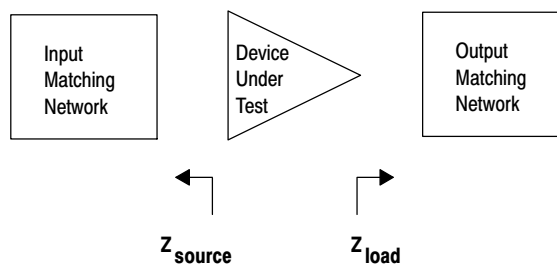
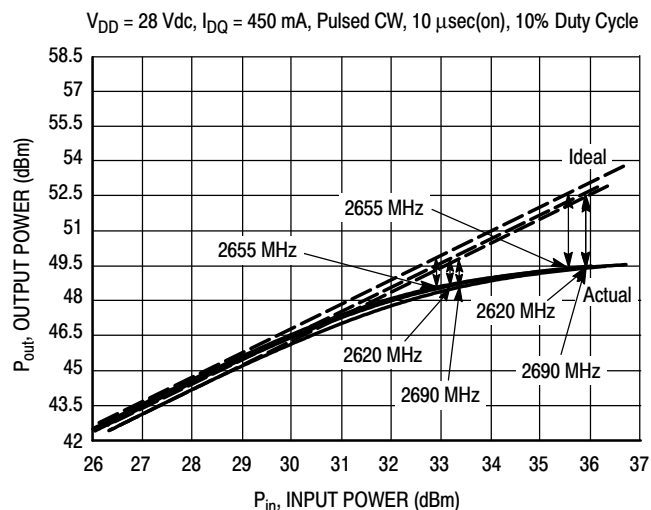

Figure 9. Series Equivalent Source and Load Impedance

ALTERNATIVE PEAK TUNE LOAD PULL CHARACTERISTICS



f (MHz)	P1dB		P3dB	
	Watts	dBm	Watts	dBm
2620	73	48.7	89	49.5
2655	73	48.6	88	49.4
2690	73	48.6	89	49.5

Test Impedances per Compression Level

f (MHz)		Z_{source} Ω	Z_{load} Ω
2620	P1dB	8.45 - j15.80	3.40 - j7.26
2655	P1dB	12.77 - j16.85	3.68 - j7.16
2690	P1dB	12.64 - j14.91	3.27 - j7.45

Figure 10. Pulsed CW Output Power versus Input Power @ 28 V

PACKAGE DIMENSIONS

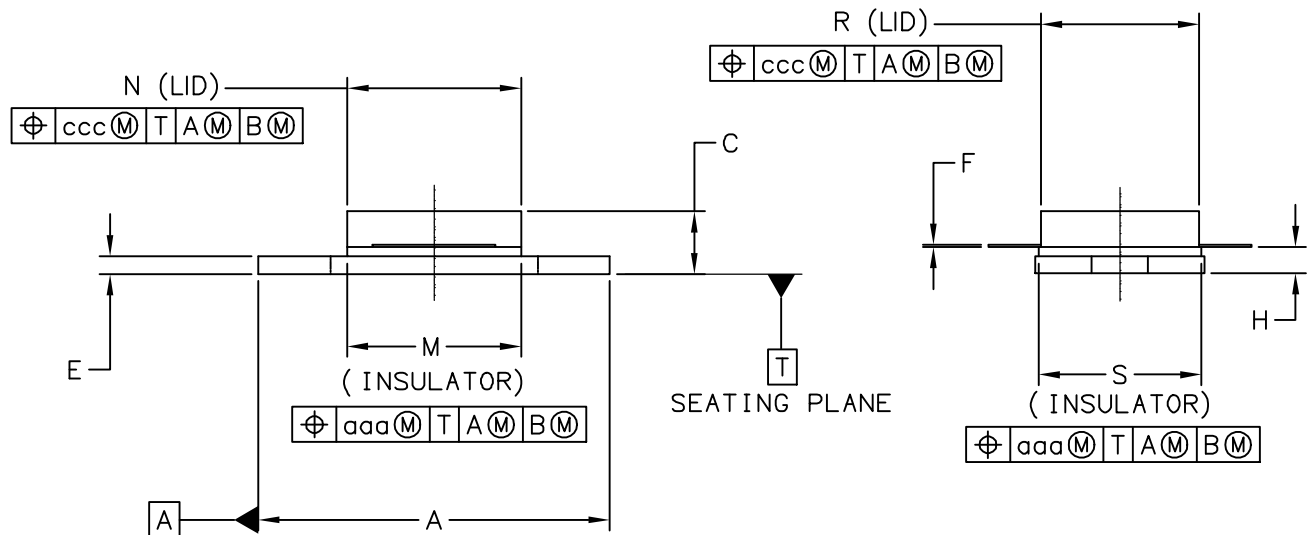
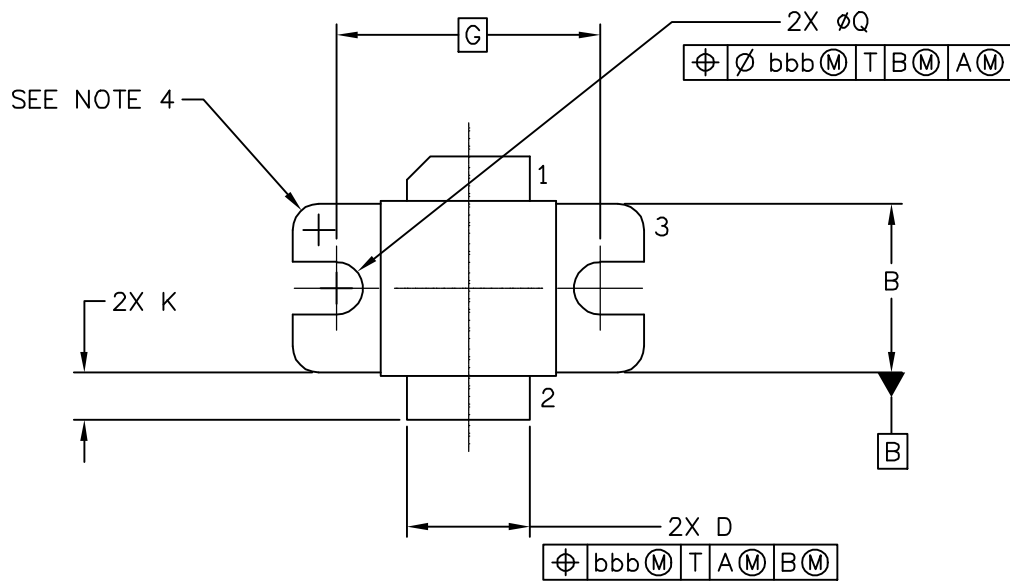

© FREESCALE SEMICONDUCTOR, INC. ALL RIGHTS RESERVED.		MECHANICAL OUTLINE		PRINT VERSION NOT TO SCALE	
TITLE: NI-400-240		DOCUMENT NO: 98ASA10730D		REV: B	
		CASE NUMBER: 465I-02		09 MAY 2006	
		STANDARD: NON-JEDEC			

MRF8S26060HR3 MRF8S26060HSR3

NOTES:

1. CONTROLLING DIMENSION: INCH
2. INTERPRET DIMENSIONS AND TOLERANCES PER ASME Y14.5M-1994.
3. DIMENSION H IS MEASURED .030 (0.762) AWAY FROM PACKAGE BODY.
4. INFORMATION ONLY:
 CORNER BREAK (4X) TO BE .060±.005 (1.52±0.13) RADIUS OR
 .06±.005 (1.52±0.13) x 45° CHAMFER.

STYLE 1
 PIN 1: DRAIN
 PIN 2: GATE
 PIN 3: SOURCE

STYLE 2
 PIN 1: GATE
 PIN 2: DRAIN
 PIN 3: SOURCE

DIM	INCH		MILLIMETER		DIM	INCH		MILLIMETER	
	MIN	MAX	MIN	MAX		MIN	MAX	MIN	MAX
A	.795	.805	20.19	20.44	R	.355	.365	9.02	9.27
B	.380	.390	9.65	9.91	S	.365	.375	9.27	9.53
C	.125	.163	3.17	4.14					
D	.275	.285	6.98	7.24	aaa	.005		0.127	
E	.035	.045	0.89	1.14	bbb	.010		0.254	
F	.004	.006	0.10	0.15	ccc	.015		0.381	
G	.600 BSC		15.24 BSC						
H	.057	.067	1.45	1.70					
K	.0995	.1295	2.53	3.29					
M	.395	.405	10.03	10.29					
N	.385	.395	9.78	10.03					
Q	∅.120	∅.130	∅3.05	∅3.30					
© FREESCALE SEMICONDUCTOR, INC. ALL RIGHTS RESERVED.			MECHANICAL OUTLINE			PRINT VERSION NOT TO SCALE			
TITLE: NI-400-240					DOCUMENT NO: 98ASA10730D			REV: B	
					CASE NUMBER: 465I-02			09 MAY 2006	
					STANDARD: NON-JEDEC				

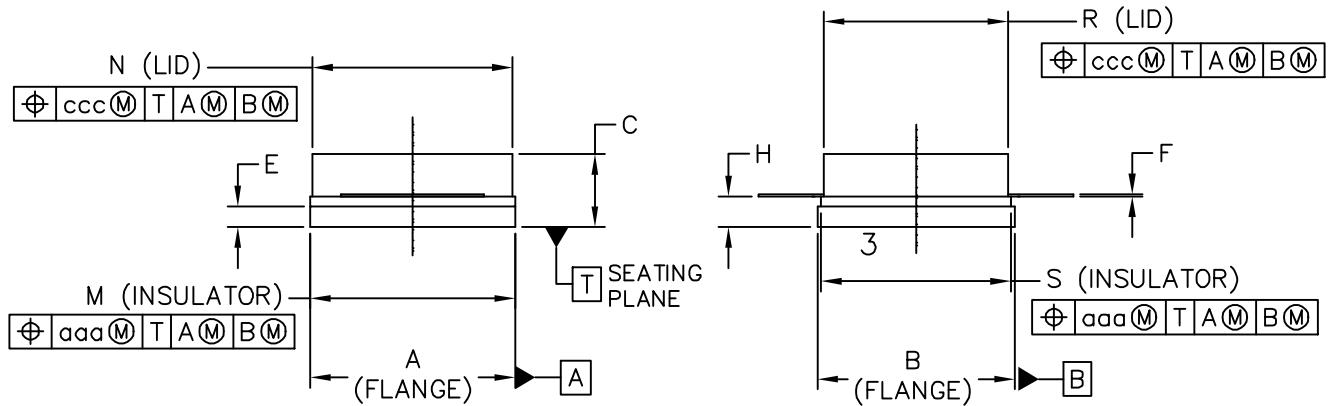
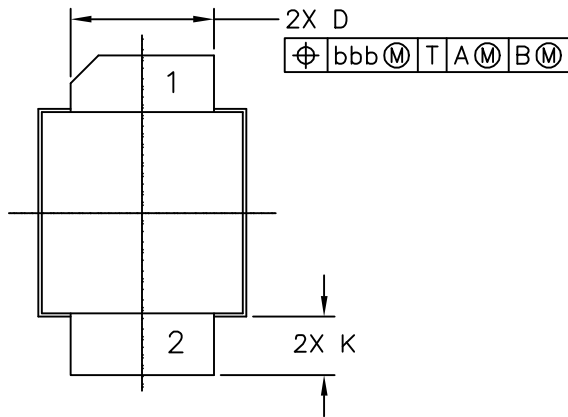

© FREESCALE SEMICONDUCTOR, INC. ALL RIGHTS RESERVED.	MECHANICAL OUTLINE	PRINT VERSION NOT TO SCALE	
TITLE: NI-400S-240	DOCUMENT NO: 98ASA10732D	REV: A	
	CASE NUMBER: 465J-02	09 MAY 2006	
	STANDARD: NON-JEDEC		

NOTES:

1. CONTROLLING DIMENSION: INCH
2. INTERPRET DIMENSIONS AND TOLERANCES PER ASME Y14.5M-1994.
3. DIMENSION H IS MEASURED .030 (0.762) AWAY FROM PACKAGE BODY

STYLE 1:

- PIN 1 - DRAIN
- 2 - GATE
- 3 - SOURCE

STYLE 2:

- PIN 1 - GATE
- 2 - DRAIN
- 3 - SOURCE

DIM	INCH		MILLIMETER		DIM	INCH		MILLIMETER	
	MIN	MAX	MIN	MAX		MIN	MAX	MIN	MAX
A	.395	.405	10.03	10.29	aaa	.005		0.127	
B	.380	.390	9.65	9.91	bbb	.010		0.254	
C	.125	.163	3.18	4.14	ccc	.015		0.381	
D	.275	.285	6.98	7.24					
E	.035	.045	0.89	1.14					
F	.004	.006	0.10	0.15					
H	.057	.067	1.45	1.70					
K	.0995	.1295	2.53	3.29					
M	.395	.405	10.03	10.29					
N	.385	.395	9.78	10.03					
R	.355	.365	9.02	9.27					
S	.365	.375	9.27	9.53					
© FREESCALE SEMICONDUCTOR, INC. ALL RIGHTS RESERVED.			MECHANICAL OUTLINE			PRINT VERSION NOT TO SCALE			
TITLE: NI-400S-240					DOCUMENT NO: 98ASA10732D			REV: A	
					CASE NUMBER: 465J-02			09 MAY 2006	
					STANDARD: NON-JEDEC				

PRODUCT DOCUMENTATION AND SOFTWARE

Refer to the following documents, tools and software to aid your design process.

Application Notes

- AN1955: Thermal Measurement Methodology of RF Power Amplifiers

Engineering Bulletins

- EB212: Using Data Sheet Impedances for RF LDMOS Devices

Software

- Electromigration MTTF Calculator
- RF High Power Model
- .s2p File

For Software, do a Part Number search at <http://www.freescale.com>, and select the “Part Number” link. Go to the Software & Tools tab on the part’s Product Summary page to download the respective tool.

REVISION HISTORY

The following table summarizes revisions to this document.

Revision	Date	Description
0	Apr. 2010	<ul style="list-style-type: none">• Initial Release of Data Sheet

How to Reach Us:

Home Page:

www.freescale.com

Web Support:

<http://www.freescale.com/support>

USA/Europe or Locations Not Listed:

Freescale Semiconductor, Inc.
Technical Information Center, EL516
2100 East Elliot Road
Tempe, Arizona 85284
1-800-521-6274 or +1-480-768-2130
www.freescale.com/support

Europe, Middle East, and Africa:

Freescale Halbleiter Deutschland GmbH
Technical Information Center
Schatzbogen 7
81829 Muenchen, Germany
+44 1296 380 456 (English)
+46 8 52200080 (English)
+49 89 92103 559 (German)
+33 1 69 35 48 48 (French)
www.freescale.com/support

Japan:

Freescale Semiconductor Japan Ltd.
Headquarters
ARCO Tower 15F
1-8-1, Shimo-Meguro, Meguro-ku,
Tokyo 153-0064
Japan
0120 191014 or +81 3 5437 9125
support.japan@freescale.com

Asia/Pacific:

Freescale Semiconductor China Ltd.
Exchange Building 23F
No. 118 Jianguo Road
Chaoyang District
Beijing 100022
China
+86 10 5879 8000
support.asia@freescale.com

For Literature Requests Only:

Freescale Semiconductor Literature Distribution Center
1-800-441-2447 or +1-303-675-2140
Fax: +1-303-675-2150
LDCForFreescaleSemiconductor@hibbertgroup.com

Information in this document is provided solely to enable system and software implementers to use Freescale Semiconductor products. There are no express or implied copyright licenses granted hereunder to design or fabricate any integrated circuits or integrated circuits based on the information in this document.

Freescale Semiconductor reserves the right to make changes without further notice to any products herein. Freescale Semiconductor makes no warranty, representation or guarantee regarding the suitability of its products for any particular purpose, nor does Freescale Semiconductor assume any liability arising out of the application or use of any product or circuit, and specifically disclaims any and all liability, including without limitation consequential or incidental damages. "Typical" parameters that may be provided in Freescale Semiconductor data sheets and/or specifications can and do vary in different applications and actual performance may vary over time. All operating parameters, including "Typicals", must be validated for each customer application by customer's technical experts. Freescale Semiconductor does not convey any license under its patent rights nor the rights of others. Freescale Semiconductor products are not designed, intended, or authorized for use as components in systems intended for surgical implant into the body, or other applications intended to support or sustain life, or for any other application in which the failure of the Freescale Semiconductor product could create a situation where personal injury or death may occur. Should Buyer purchase or use Freescale Semiconductor products for any such unintended or unauthorized application, Buyer shall indemnify and hold Freescale Semiconductor and its officers, employees, subsidiaries, affiliates, and distributors harmless against all claims, costs, damages, and expenses, and reasonable attorney fees arising out of, directly or indirectly, any claim of personal injury or death associated with such unintended or unauthorized use, even if such claim alleges that Freescale Semiconductor was negligent regarding the design or manufacture of the part.

Freescale™ and the Freescale logo are trademarks of Freescale Semiconductor, Inc. All other product or service names are the property of their respective owners.

© Freescale Semiconductor, Inc. 2010. All rights reserved.