



RF Power Field Effect Transistors

N-Channel Enhancement-Mode Lateral MOSFETs

Designed for CDMA base station applications with frequencies from 1880 to 2025 MHz. Can be used in Class AB and Class C for all typical cellular base station modulation formats.

- Typical Doherty Single-Carrier W-CDMA Performance: $V_{DD} = 28$ Volts, $I_{DQA} = 500$ mA, $V_{GSB} = 1.2$ Vdc, $P_{out} = 24$ Watts Avg., IQ Magnitude Clipping, Channel Bandwidth = 3.84 MHz, Input Signal PAR = 9.9 dB @ 0.01% Probability on CCDF.

Frequency	G_{ps} (dB)	η_D (%)	Output PAR (dB)	ACPR (dBc)
1880 MHz	16.0	42.8	8.0	-31.0
1920 MHz	16.0	43.7	8.1	-32.6
2025 MHz	15.9	42.0	8.1	-31.2

- Capable of Handling 10:1 VSWR, @ 30 Vdc, 1920 MHz, 160 Watts CW (1) Output Power (3 dB Input Overdrive from Rated P_{out})
- Typical P_{out} @ 3 dB Compression Point = 170 Watts (1,2)

Features

- Designed for Wide Instantaneous Bandwidth Applications. $VBW_{res} \approx 240$ MHz.
- Designed for Wideband Applications that Require 160 MHz Signal Bandwidth
- Production Tested in a Symmetrical Doherty Configuration
- 100% PAR Tested for Guaranteed Output Power Capability
- Characterized with Large-Signal Load-Pull Parameters and Common Source S-Parameters
- Internally Matched for Ease of Use
- Integrated ESD Protection
- Greater Negative Gate-Source Voltage Range for Improved Class C Operation
- Designed for Digital Predistortion Error Correction Systems
- RoHS Compliant
- NI-780-4 in Tape and Reel. R3 Suffix = 250 Units, 56 mm Tape Width, 13 inch Reel. For R5 Tape and Reel option, see p. 14.
- NI-780S-4 in Tape and Reel. R3 Suffix = 250 Units, 32 mm Tape Width, 13 inch Reel. For R5 Tape and Reel option, see p. 14.

MRF8P20140WHR3
MRF8P20140WHSR3

1880-2025 MHz, 24 W AVG., 28 V
SINGLE W-CDMA
LATERAL N-CHANNEL
RF POWER MOSFETs

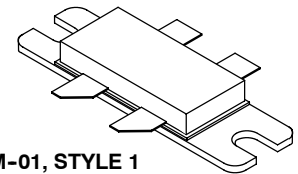

CASE 465M-01, STYLE 1
NI-780-4
MRF8P20140WHR3

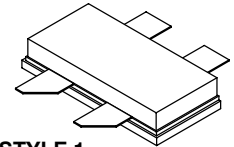

CASE 465H-02, STYLE 1
NI-780S-4
MRF8P20140WHSR3

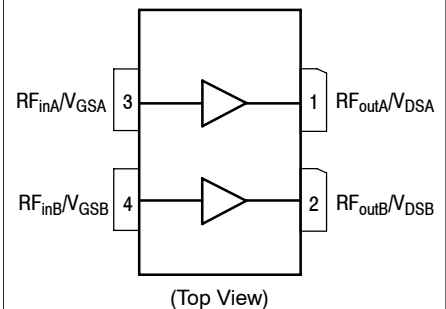

Figure 1. Pin Connections

Table 1. Maximum Ratings

Rating	Symbol	Value	Unit
Drain-Source Voltage	V_{DSS}	-0.5, +65	Vdc
Gate-Source Voltage	V_{GS}	-6.0, +10	Vdc
Operating Voltage	V_{DD}	32, +0	Vdc
Storage Temperature Range	T_{stg}	-65 to +150	°C
Case Operating Temperature	T_C	125	°C
Operating Junction Temperature (3)	T_J	225	°C
CW Operation @ $T_C = 25^\circ\text{C}$ Derate above 25°C	CW	140 0.66	W W/°C

- Exceeds recommended operating conditions. See CW operation data in Maximum Ratings table.
- $P_{3dB} = P_{avg} + 7.0$ dB where P_{avg} is the average output power measured using an unclipped W-CDMA single-carrier input signal where output PAR is compressed to 7.0 dB @ 0.01% probability on CCDF.
- Continuous use at maximum temperature will affect MTTF.

Table 2. Thermal Characteristics

Characteristic	Symbol	Value (1)	Unit
Thermal Resistance, Junction to Case Case Temperature 80°C, 24 W CW, 28 Vdc, I _{DQA} = 500 mA, V _{G_{SB}} = 1.2 Vdc, 1920 MHz Case Temperature 96°C, 130 W CW(2), 28 Vdc, I _{DQA} = 500 mA, V _{G_{SB}} = 1.2 Vdc, 1920 MHz	R _{θJC}	0.68 0.40	°C/W

Table 3. ESD Protection Characteristics

Test Methodology	Class
Human Body Model (per JESD22-A114)	2 (Minimum)
Machine Model (per EIA/JESD22-A115)	A (Minimum)
Charge Device Model (per JESD22-C101)	IV (Minimum)

Table 4. Electrical Characteristics (T_A = 25°C unless otherwise noted)

Characteristic	Symbol	Min	Typ	Max	Unit
----------------	--------	-----	-----	-----	------

Off Characteristics (3)

Zero Gate Voltage Drain Leakage Current (V _{DS} = 65 Vdc, V _{GS} = 0 Vdc)	I _{DSS}	—	—	10	μAdc
Zero Gate Voltage Drain Leakage Current (V _{DS} = 28 Vdc, V _{GS} = 0 Vdc)	I _{DSS}	—	—	5	μAdc
Gate-Source Leakage Current (V _{GS} = 5 Vdc, V _{DS} = 0 Vdc)	I _{GSS}	—	—	1	μAdc

On Characteristics (3,4)

Gate Threshold Voltage (V _{DS} = 10 Vdc, I _D = 200 μAdc)	V _{GS(th)}	1.1	1.8	2.6	Vdc
Gate Quiescent Voltage (V _{DS} = 28 Vdc, I _{DA} = 500 mAdc)	V _{GSA(Q)}	—	2.6	—	Vdc
Fixture Gate Quiescent Voltage (5) (V _{DD} = 28 Vdc, I _{DA} = 500 mAdc, Measured in Functional Test)	V _{GGA(Q)}	4.5	5.2	6.0	Vdc
Drain-Source On-Voltage (V _{GS} = 10 Vdc, I _D = 2 Adc)	V _{DS(on)}	0.1	0.2	0.3	Vdc

Functional Tests (4,6,7) (In Freescale Doherty Test Fixture, 50 ohm system) V_{DD} = 28 Vdc, I_{DQA} = 500 mA, V_{G_{SB}} = 1.2 Vdc, P_{out} = 24 W Avg., f₁ = 1880 MHz, f₂ = 1910 MHz, 2-Carrier W-CDMA, IQ Magnitude Clipping, Input Signal PAR = 9.8 dB @ 0.01% Probability on CCDF. ACPR measured in 3.84 MHz Channel Bandwidth @ ±5 MHz Offset.

Power Gain	G _{ps}	15.0	16.0	18.0	dB
Drain Efficiency	η _D	37.5	41.2	—	%
Output Peak-to-Average Ratio @ 0.01% Probability on CCDF	PAR	7.3	7.7	—	dB
Adjacent Channel Power Ratio	ACPR	—	-31.9	-29.5	dBc

Typical Broadband Performance (7) — (In Freescale Doherty Test Fixture, 50 ohm system) V_{DD} = 28 Vdc, I_{DQA} = 500 mA, V_{G_{SB}} = 1.2 Vdc, P_{out} = 24 W Avg., Single-Carrier W-CDMA, IQ Magnitude Clipping, Input Signal PAR = 9.9 dB @ 0.01% Probability on CCDF. ACPR measured in 3.84 MHz Channel Bandwidth @ ±5 MHz Offset.

Frequency	G _{ps} (dB)	η _D (%)	Output PAR (dB)	ACPR (dBc)
1880 MHz	16.0	42.8	8.0	-31.0
1920 MHz	16.0	43.7	8.1	-32.6
2025 MHz	15.9	42.0	8.1	-31.2

1. Refer to AN1955, *Thermal Measurement Methodology of RF Power Amplifiers*. Go to <http://www.freescale.com/rf>. Select Documentation/Application Notes - AN1955.
2. Exceeds recommended operating conditions. See CW operation data in Maximum Ratings table.
3. Each side of device measured separately.
4. V_{DDA} and V_{ddb} must be tied together and powered by a single DC power supply.
5. V_{GG} = 2.0 × V_{GS(Q)}. Parameter measured on Freescale Test Fixture, due to resistive divider network on the board. Refer to Test Circuit schematic.
6. Part internally matched both on input and output.
7. Measurement made with device in a Symmetrical Doherty configuration.

(continued)

Table 4. Electrical Characteristics ($T_A = 25^\circ\text{C}$ unless otherwise noted) (continued)

Characteristic	Symbol	Min	Typ	Max	Unit
Typical Performances ⁽¹⁾ (In Freescale Doherty Test Fixture, 50 ohm system) $V_{DD} = 28\text{ Vdc}$, $I_{DQA} = 500\text{ mA}$, $V_{GSB} = 1.2\text{ Vdc}$, 1880–2025 MHz Bandwidth					
P_{out} @ 1 dB Compression Point, CW	P1dB	—	140	—	W
P_{out} @ 3 dB Compression Point ⁽²⁾	P3dB	—	170 ⁽³⁾	—	W
IMD Symmetry @ 24 W PEP, P_{out} where IMD Third Order Intermodulation $\cong 30\text{ dBc}$ (Delta IMD Third Order Intermodulation between Upper and Lower Sidebands > 2 dB)	IMD _{sym}	—	133	—	MHz
VBW Resonance Point (IMD Third Order Intermodulation Inflection Point)	VBW _{res}	—	240	—	MHz
Gain Flatness in 145 MHz Bandwidth @ $P_{out} = 24\text{ W Avg.}$	G _F	—	0.25	—	dB
Gain Variation over Temperature (-30°C to $+85^\circ\text{C}$)	ΔG	—	0.013	—	dB/ $^\circ\text{C}$
Output Power Variation over Temperature (-30°C to $+85^\circ\text{C}$) ⁽³⁾	ΔP_{1dB}	—	0.003	—	dB/ $^\circ\text{C}$

1. Measurement made with device in a Symmetrical Doherty configuration.
2. P3dB = $P_{avg} + 7.0\text{ dB}$ where P_{avg} is the average output power measured using an unclipped W-CDMA single-carrier input signal where output PAR is compressed to 7.0 dB @ 0.01% probability on CCDF.
3. Exceeds recommended operating conditions. See CW operation data in Maximum Ratings table.

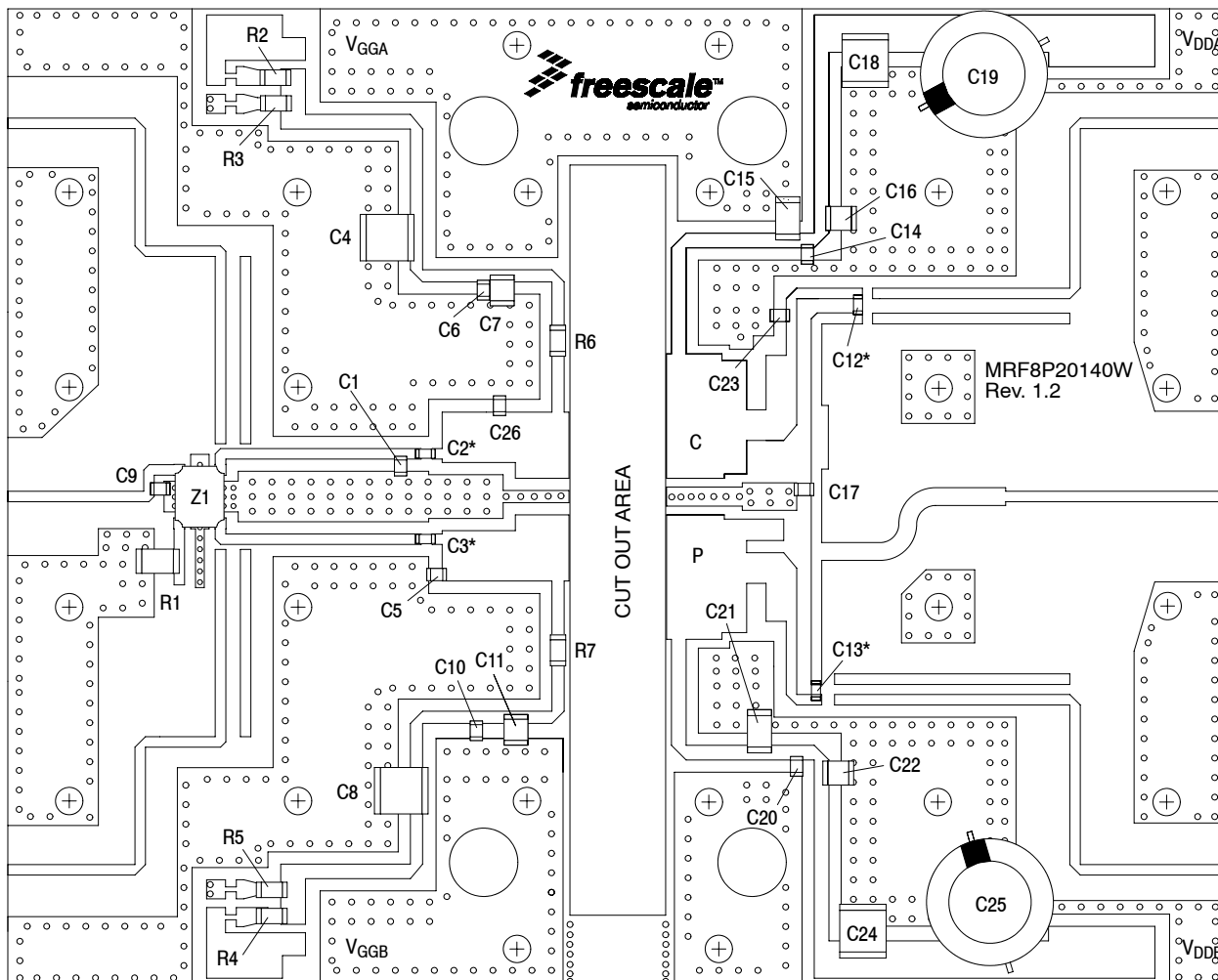

Note 1: * denotes that C2, C3, C12 and C13 are mounted vertically.

Note 2: V_{DDA} and V_{ddb} must be tied together and powered by a single DC power supply.

Figure 2. MRF8P20140WHR3(WHSR3) Test Circuit Component Layout

Table 5. MRF8P20140WHR3(WHSR3) Test Circuit Component Designations and Values

Part	Description	Part Number	Manufacturer
C1	0.6 pF Chip Capacitor	ATC600F0R6BT250XT	ATC
C2, C3	8.2 pF Chip Capacitors	ATC600F8R2BT250XT	ATC
C4, C8, C18, C24	10 μ F, 50 V Chip Capacitors	GRM55DR61H106KA88L	Murata
C5	1.2 pF Chip Capacitor	ATC600F1R2BT250XT	ATC
C6, C10, C12, C13, C14, C20	12 pF Chip Capacitors	ATC600F120JT250XT	ATC
C7, C11	10 μ F, 32 V Chip Capacitors	GRM32ER61H106KA12L	Murata
C9, C17	0.1 pF Chip Capacitors	ATC600F0R1BT250XT	ATC
C15, C21	6.8 μ F, 50 V Chip Capacitors	C4532X7R1H685KT	TDK
C16, C22	2.2 μ F, 100 V Chip Capacitors	C3225X7R2A225KT	TDK
C19, C25	220 μ F, 100 V Chip Capacitors	EEV-FK2A221M	Panasonic-ECG
C23	0.2 pF Chip Capacitor	ATC600F0R2BT250XT	ATC
C26	1.5 pF Chip Capacitor	ATC600F1R5BT250XT	ATC
R1	50 Ω , Chip Resistor	ATCCW12010T0050GBK	ATC
R2, R3, R4, R5	1.5 k Ω , 1/4 W Chip Resistors	CRCW12061K50FKEA	Vishay
R6, R7	2.2 Ω , 1/4 W Chip Resistors	CRCW12062R2FNEA	Vishay
Z1	1700-2000 MHz Band 90°, 3 dB Hybrid Coupler	1P503S	Anaren
PCB	0.020", $\epsilon_r = 3.5$	R04350B	Rogers

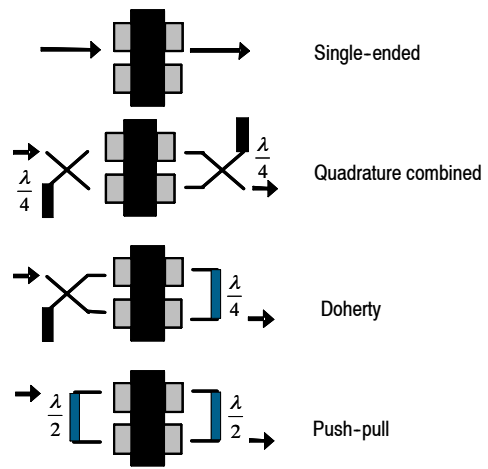

Figure 3. Possible Circuit Topologies

TYPICAL CHARACTERISTICS

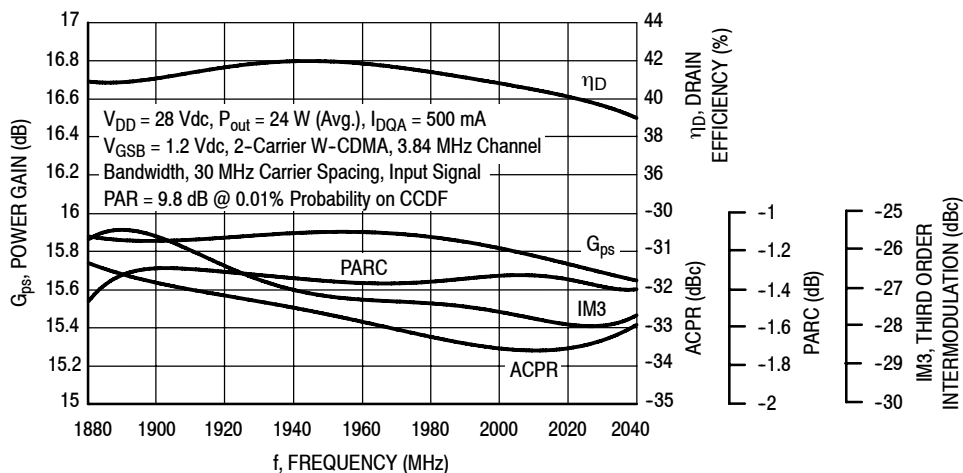

Figure 4. 2-Carrier Output Peak-to-Average Ratio Compression (PARC) Broadband Performance @ $P_{out} = 24$ Watts Avg.

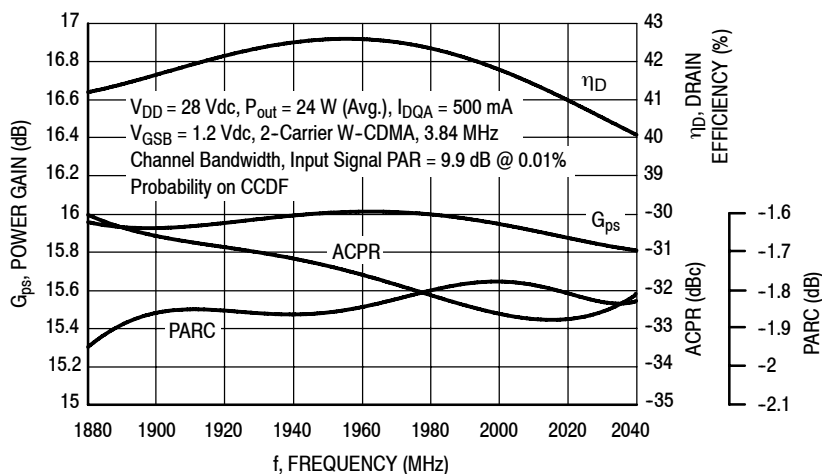

Figure 5. Single-Carrier Output Peak-to-Average Ratio Compression (PARC) Broadband Performance @ $P_{out} = 24$ Watts Avg.

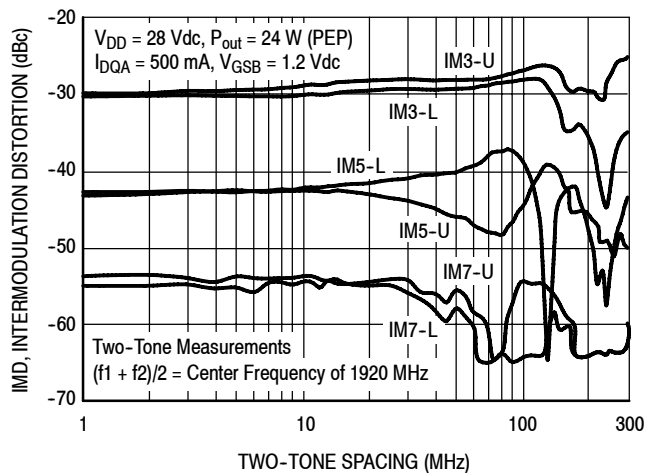

Figure 6. Intermodulation Distortion Products versus Two-Tone Spacing

TYPICAL CHARACTERISTICS

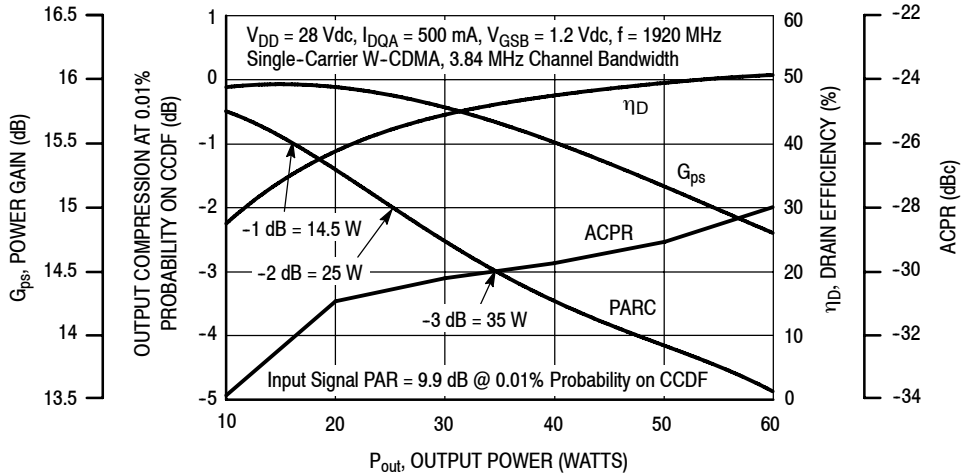

Figure 7. Output Peak-to-Average Ratio Compression (PARC) versus Output Power

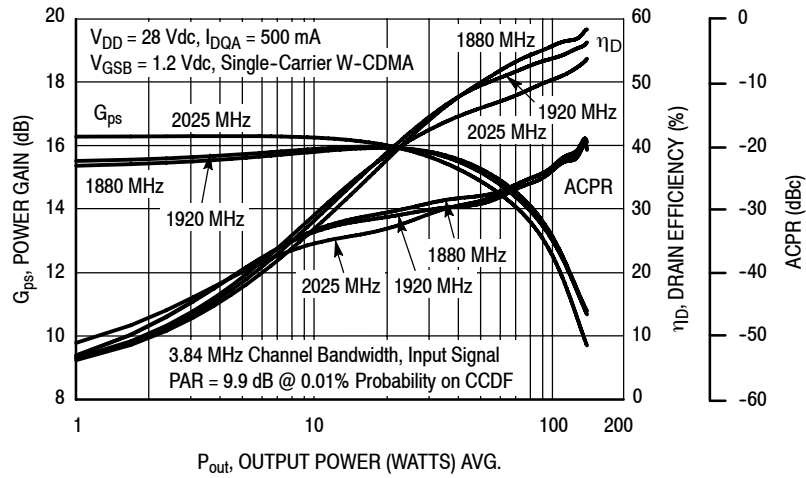

Figure 8. Single-Carrier W-CDMA Power Gain, Drain Efficiency and ACPR versus Output Power

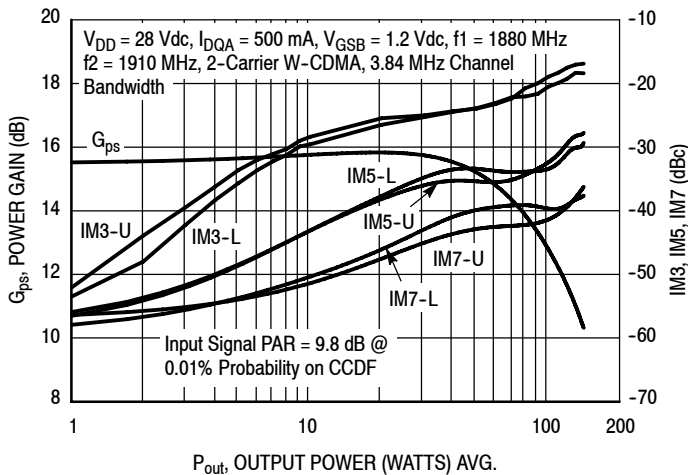

Figure 9. 2-Carrier W-CDMA Power Gain, IM3, IM5, IM7 versus Output Power

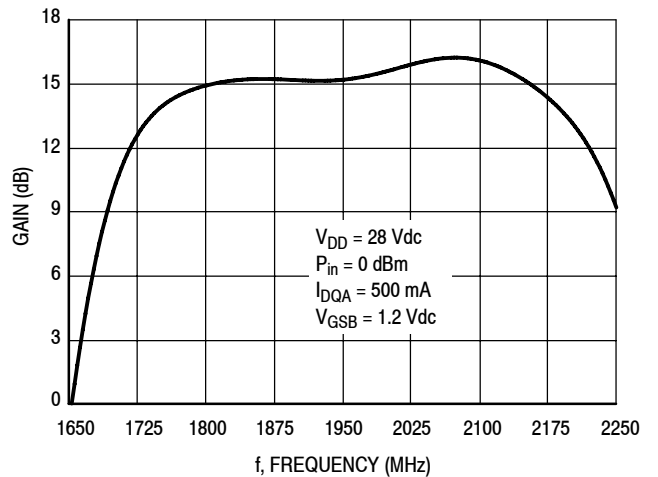

Figure 10. Broadband Frequency Response

W-CDMA TEST SIGNAL

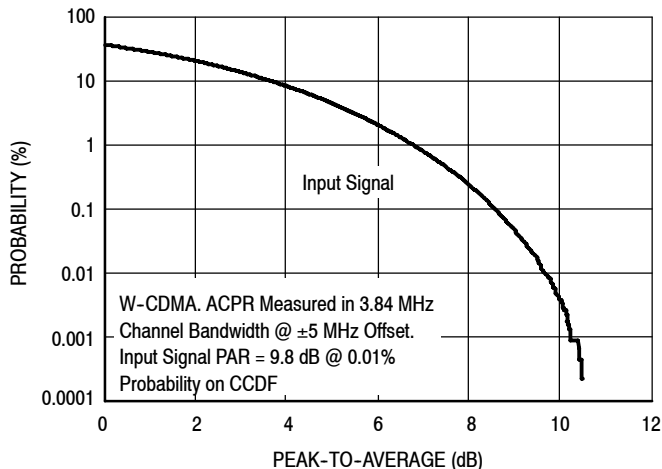

Figure 11. CCDF W-CDMA IQ Magnitude Clipping, 2-Carrier Test Signal

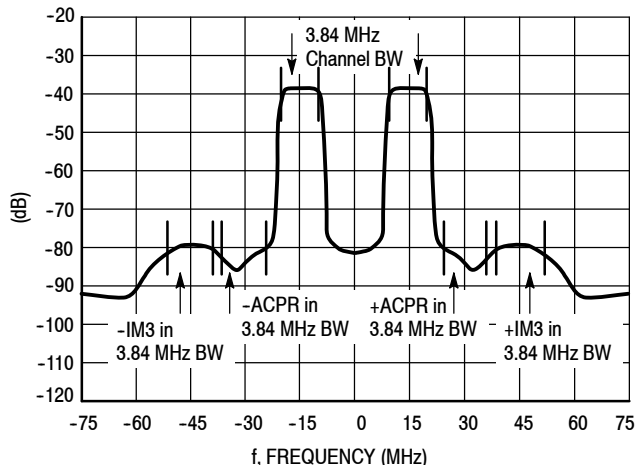

Figure 12. 2-Carrier W-CDMA Spectrum

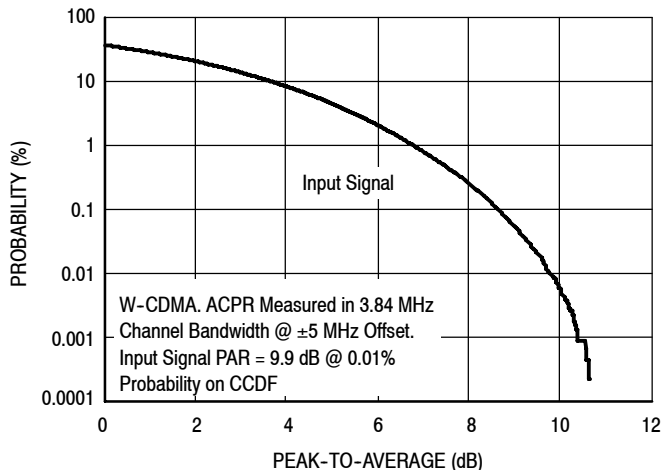

Figure 13. CCDF W-CDMA IQ Magnitude Clipping, Single-Carrier Test Signal

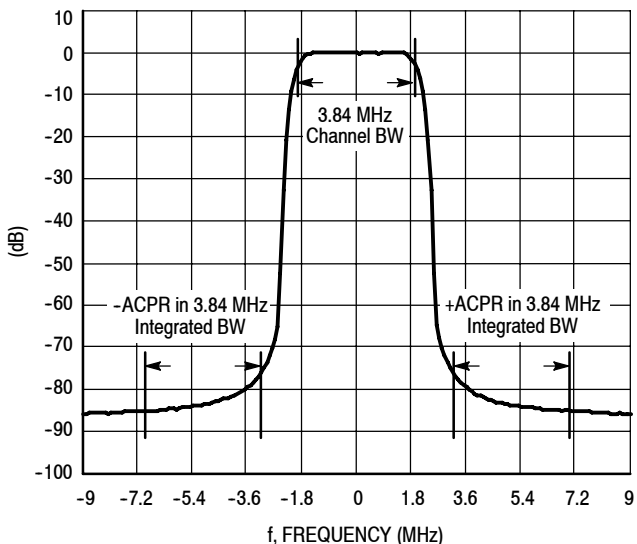

Figure 14. Single-Carrier W-CDMA Spectrum

$V_{DD} = 28 \text{ Vdc}$, $I_{DQA} = 500 \text{ mA}$, Pulsed CW, $10 \mu\text{sec}(\text{on})$, 10% Duty Cycle

f (MHz)	$Z_{\text{source}} (\Omega)$	$Z_{\text{load}}^{(1)} (\Omega)$	Max Output Power					
			P1dB			P3dB		
			(dBm)	(W)	η_D (%)	(dBm)	(W)	η_D (%)
1880	$5.35 - j5.03$	$2.36 - j4.84$	49.7	93	53.7	50.5	113	56.2
1930	$7.39 - j5.10$	$2.57 - j4.73$	50.0	100	56.9	50.8	119	59.3
1990	$9.46 - j1.71$	$2.48 - j5.11$	50.0	100	56.4	50.7	118	58.6
2025	$9.30 + j0.80$	$2.50 - j5.30$	50.0	100	56.7	50.7	118	59.1

(1) Load impedance for optimum P1dB power.

Z_{source} = Impedance as measured from gate contact to ground.

Z_{load} = Impedance as measured from drain contact to ground.

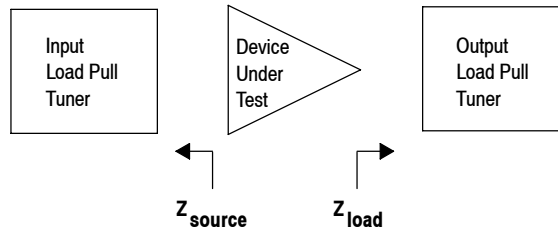

Figure 15. Carrier Side Load Pull Performance — Maximum P1dB Tuning

$V_{DD} = 28 \text{ Vdc}$, $I_{DQA} = 500 \text{ mA}$, Pulsed CW, $10 \mu\text{sec}(\text{on})$, 10% Duty Cycle

f (MHz)	$Z_{\text{source}} (\Omega)$	$Z_{\text{load}}^{(1)} (\Omega)$	Max Drain Efficiency					
			P1dB			P3dB		
			(dBm)	(W)	η_D (%)	(dBm)	(W)	η_D (%)
1880	$5.35 - j5.03$	$6.91 - j4.37$	47.6	57	64.6	48.2	67	65.2
1930	$7.39 - j5.10$	$6.36 - j3.60$	48.0	63	67.3	48.6	72	68.3
1990	$9.46 - j1.71$	$5.61 - j3.11$	48.0	63	67.2	48.6	72	67.8
2025	$9.30 + j0.80$	$5.28 - j2.88$	47.9	61	66.5	48.5	70	67.3

(1) Load impedance for optimum P1dB efficiency.

Z_{source} = Impedance as measured from gate contact to ground.

Z_{load} = Impedance as measured from drain contact to ground.

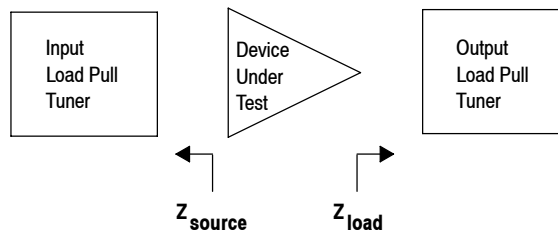
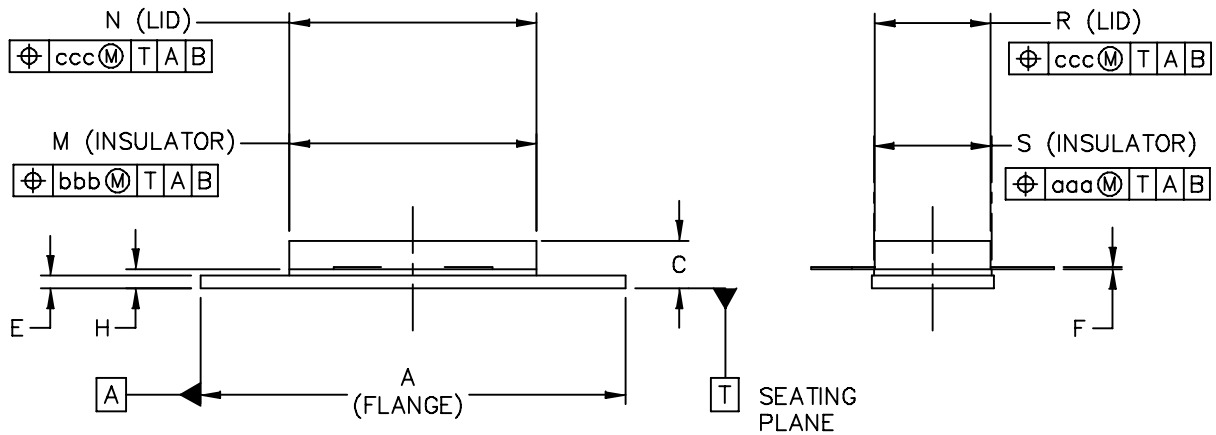
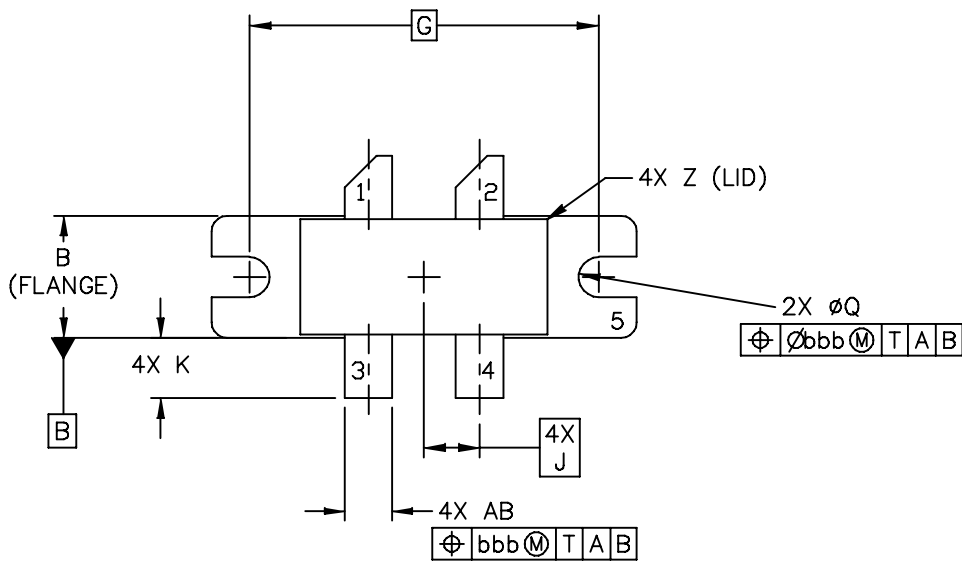

Figure 16. Carrier Side Load Pull Performance — Maximum Efficiency Tuning

PACKAGE DIMENSIONS



© FREESCALE SEMICONDUCTOR, INC. ALL RIGHTS RESERVED.	MECHANICAL OUTLINE	PRINT VERSION NOT TO SCALE
TITLE: NI 780-4	DOCUMENT NO: 98ASA10793D	REV: 0
	CASE NUMBER: 465M-01	27 MAR 2007
	STANDARD: NON-JEDEC	

NOTES:

1. DIMENSIONING AND TOLERANCING PER ANSI Y14.5M-1994.
2. CONTROLLING DIMENSION: INCH.
3. DIMENSION H IS MEASURED .030 (0.762) AWAY FROM PACKAGE BODY.

STYLE 1:

- PIN 1. DRAIN
 2. DRAIN
 3. GATE
 4. GATE
 5. SOURCE

DIM	INCH		MILLIMETER		DIM	INCH		MILLIMETER	
	MIN	MAX	MIN	MAX		MIN	MAX	MIN	MAX
A	1.335	1.345	33.91	34.16	R	.365	.375	9.27	9.53
B	.380	.390	9.65	9.91	S	.365	.375	9.27	9.52
C	.125	.170	3.18	4.32	U		.040		1.02
E	.035	.045	0.89	1.14	Z		.030		0.76
F	.003	.006	0.08	0.15	AB	.145	.155	3.68	3.94
G	1.100 BSC		27.94 BSC						
H	.057	.067	1.45	1.7	aaa		.005		0.127
J	.175 BSC		4.44 BSC		bbb		.010		0.254
K	.170	.210	4.32	5.33	ccc		.015		0.381
M	.774	.786	19.61	20.02					
N	.772	.788	19.61	20.02					
Q	Ø.118	Ø.138	Ø3	Ø3.51					
© FREESCALE SEMICONDUCTOR, INC. ALL RIGHTS RESERVED.			MECHANICAL OUTLINE			PRINT VERSION NOT TO SCALE			
TITLE: NI 780-4					DOCUMENT NO: 98ASA10793D			REV: 0	
					CASE NUMBER: 465M-01			27 MAR 2007	
					STANDARD: NON-JEDEC				

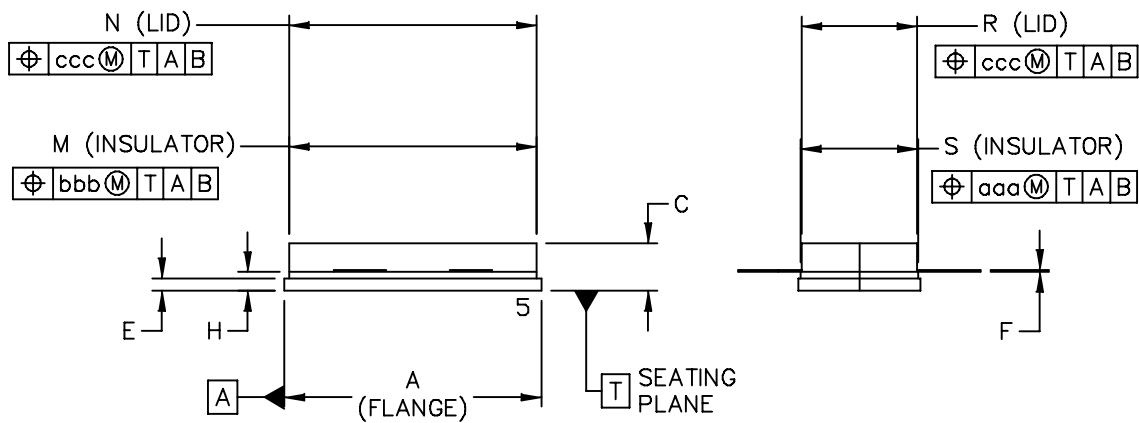
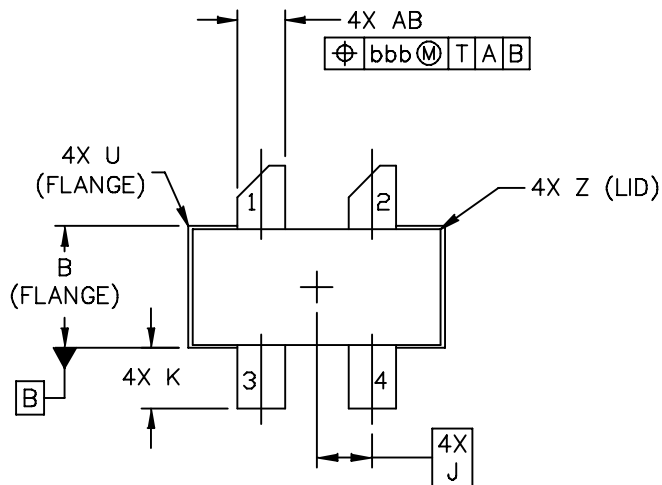

© FREESCALE SEMICONDUCTOR, INC. ALL RIGHTS RESERVED.	MECHANICAL OUTLINE	PRINT VERSION NOT TO SCALE	
TITLE: NI 780S-4	DOCUMENT NO: 98ASA10718D	REV: A	
	CASE NUMBER: 465H-02	27 MAR 2007	
	STANDARD: NON-JEDEC		

NOTES:

1. DIMENSIONING AND TOLERANCING PER ANSI Y14.5M-1994.
2. CONTROLLING DIMENSION: INCH.
3. DELETED
4. DIMENSION H IS MEASURED .030 (0.762) AWAY FROM PACKAGE BODY.

STYLE 1:

- PIN 1. DRAIN
2. DRAIN
3. GATE
4. GATE
5. SOURCE

DIM	INCH		MILLIMETER		DIM	INCH		MILLIMETER	
	MIN	MAX	MIN	MAX		MIN	MAX	MIN	MAX
A	.805	.815	20.45	20.7	U		.040		1.02
B	.380	.390	9.65	9.91	Z		.030		0.76
C	.125	.170	3.18	4.32	AB	.145	.155	3.68	– 3.94
E	.035	.045	0.89	1.14					
F	.003	.006	0.08	0.15	aaa		.005		0.127
H	.057	.067	1.45	1.7	bbb		.010		0.254
J	.175 BSC		4.44 BSC		ccc		.015		0.381
K	.170	.210	4.32	5.33					
M	.774	.786	19.61	20.02					
N	.772	.788	19.61	20.02					
R	.365	.375	9.27	9.53					
S	.365	.375	9.27	9.52					
© FREESCALE SEMICONDUCTOR, INC. ALL RIGHTS RESERVED.			MECHANICAL OUTLINE			PRINT VERSION NOT TO SCALE			
TITLE: NI 780S-4					DOCUMENT NO: 98ASA10718D			REV: A	
					CASE NUMBER: 465H-02			27 MAR 2007	
					STANDARD: NON-JEDEC				

PRODUCT DOCUMENTATION, SOFTWARE AND TOOLS

Refer to the following documents, Software and Tools to aid your design process.

Application Notes

- AN1955: Thermal Measurement Methodology of RF Power Amplifiers

Engineering Bulletins

- EB212: Using Data Sheet Impedances for RF LDMOS Devices

Software

- .s2p File

For Software and Tools, do a Part Number search at <http://www.freescale.com>, and select the "Part Number" link. Go to the Software & Tools tab on the part's Product Summary page to download the respective tool.

R5 TAPE AND REEL OPTION

R5 Suffix = 50 Units, 56 mm Tape Width, 13 inch Reel.

The R5 tape and reel option for MRF8P20140WH and MRF8P20140WHS parts will be available for 2 years after release of MRF8P20140WH and MRF8P20140WHS. Freescale Semiconductor, Inc. reserves the right to limit the quantities that will be delivered in the R5 tape and reel option. At the end of the 2 year period customers who have purchased these devices in the R5 tape and reel option will be offered MRF8P20140WH and MRF8P20140WHS in the R3 tape and reel option.

REVISION HISTORY

The following table summarizes revisions to this document.

Revision	Date	Description
0	Apr. 2011	• Initial Release of Data Sheet

How to Reach Us:

Home Page:

www.freescale.com

Web Support:

<http://www.freescale.com/support>

USA/Europe or Locations Not Listed:

Freescale Semiconductor, Inc.
Technical Information Center, EL516
2100 East Elliot Road
Tempe, Arizona 85284
1-800-521-6274 or +1-480-768-2130
www.freescale.com/support

Europe, Middle East, and Africa:

Freescale Halbleiter Deutschland GmbH
Technical Information Center
Schatzbogen 7
81829 Muenchen, Germany
+44 1296 380 456 (English)
+46 8 52200080 (English)
+49 89 92103 559 (German)
+33 1 69 35 48 48 (French)
www.freescale.com/support

Japan:

Freescale Semiconductor Japan Ltd.
Headquarters
ARCO Tower 15F
1-8-1, Shimo-Meguro, Meguro-ku,
Tokyo 153-0064
Japan
0120 191014 or +81 3 5437 9125
support.japan@freescale.com

Asia/Pacific:

Freescale Semiconductor China Ltd.
Exchange Building 23F
No. 118 Jianguo Road
Chaoyang District
Beijing 100022
China
+86 10 5879 8000
support.asia@freescale.com

For Literature Requests Only:

Freescale Semiconductor Literature Distribution Center
1-800-441-2447 or +1-303-675-2140
Fax: +1-303-675-2150
LDCForFreescaleSemiconductor@hibbertgroup.com

Information in this document is provided solely to enable system and software implementers to use Freescale Semiconductor products. There are no express or implied copyright licenses granted hereunder to design or fabricate any integrated circuits or integrated circuits based on the information in this document.

Freescale Semiconductor reserves the right to make changes without further notice to any products herein. Freescale Semiconductor makes no warranty, representation or guarantee regarding the suitability of its products for any particular purpose, nor does Freescale Semiconductor assume any liability arising out of the application or use of any product or circuit, and specifically disclaims any and all liability, including without limitation consequential or incidental damages. "Typical" parameters that may be provided in Freescale Semiconductor data sheets and/or specifications can and do vary in different applications and actual performance may vary over time. All operating parameters, including "Typicals", must be validated for each customer application by customer's technical experts. Freescale Semiconductor does not convey any license under its patent rights nor the rights of others. Freescale Semiconductor products are not designed, intended, or authorized for use as components in systems intended for surgical implant into the body, or other applications intended to support or sustain life, or for any other application in which the failure of the Freescale Semiconductor product could create a situation where personal injury or death may occur. Should Buyer purchase or use Freescale Semiconductor products for any such unintended or unauthorized application, Buyer shall indemnify and hold Freescale Semiconductor and its officers, employees, subsidiaries, affiliates, and distributors harmless against all claims, costs, damages, and expenses, and reasonable attorney fees arising out of, directly or indirectly, any claim of personal injury or death associated with such unintended or unauthorized use, even if such claim alleges that Freescale Semiconductor was negligent regarding the design or manufacture of the part.

Freescale™ and the Freescale logo are trademarks of Freescale Semiconductor, Inc. All other product or service names are the property of their respective owners.

© Freescale Semiconductor, Inc. 2011. All rights reserved.

