

# 74ACTQ00

## Quiet Series™ Quad 2-Input NAND Gate

### Features

- $I_{CC}$  reduced by 50%
- Guaranteed simultaneous switching noise level and dynamic threshold performance
- Improved latch-up immunity
- Outputs source/sink 24mA
- Has TTL-compatible inputs

### General Description

The ACTQ00 contains four 2-input NAND gates and utilizes Fairchild FACT Quiet Series™ technology to guarantee quiet output switching and improve dynamic threshold performance. FACT Quiet Series features GTO™ output control and undershoot corrector in addition to a split ground bus for superior AC MOS performance.

### Ordering Information

Order Number	Package Number	Package Description
74ACTQ00SC	M14A	14-Lead Small Outline Integrated Circuit (SOIC), JEDEC MS-012, 0.150" Narrow
74ACTQ00MTC	MTC14	14-Lead Thin Shrink Small Outline Package (TSSOP), JEDEC MO-153, 4.4mm Wide

Device also available in Tape and Reel. Specify by appending suffix letter "X" to the ordering number.

### Connection Diagram

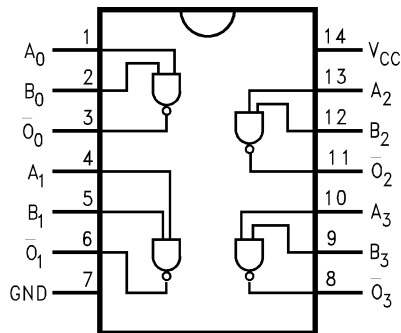

### Logic Symbol

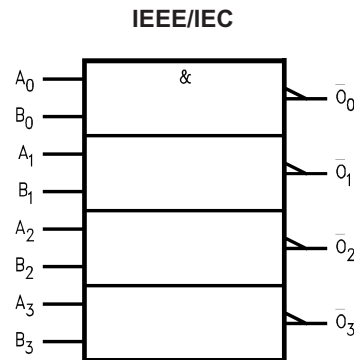

### Pin Description

Pin Names	Description
$A_n, B_n$	Inputs
$\bar{O}_n$	Outputs

## Absolute Maximum Ratings

Stresses exceeding the absolute maximum ratings may damage the device. The device may not function or be operable above the recommended operating conditions and stressing the parts to these levels is not recommended. In addition, extended exposure to stresses above the recommended operating conditions may affect device reliability. The absolute maximum ratings are stress ratings only.

Symbol	Parameter	Rating
$V_{CC}$	Supply Voltage	-0.5V to +7.0V
$I_{IK}$	DC Input Diode Current $V_I = -0.5V$ $V_I = V_{CC} + 0.5V$	-20mA +20mA
$V_I$	DC Input Voltage	-0.5V to $V_{CC} + 0.5V$
$I_{OK}$	DC Output Diode Current $V_O = -0.5V$ $V_O = V_{CC} + 0.5V$	-20mA +20mA
$V_O$	DC Output Voltage	-0.5V to $V_{CC} + 0.5V$
$I_O$	DC Output Source or Sink Current	$\pm 50mA$
$I_{CC}$ or $I_{GND}$	DC $V_{CC}$ or Ground Current per Output Pin	$\pm 50mA$
$T_{STG}$	Storage Temperature	-65°C to +150°C
	DC Latch-Up Source or Sink Current	$\pm 300mA$
$T_J$	Junction Temperature	140°C

## Recommended Operating Conditions

The Recommended Operating Conditions table defines the conditions for actual device operation. Recommended operating conditions are specified to ensure optimal performance to the datasheet specifications. Fairchild does not recommend exceeding them or designing to absolute maximum ratings.

Symbol	Parameter	Rating
$V_{CC}$	Supply Voltage	4.5V to 5.5V
$V_I$	Input Voltage	0V to $V_{CC}$
$V_O$	Output Voltage	0V to $V_{CC}$
$T_A$	Operating Temperature	-40°C to +85°C
$\Delta V / \Delta t$	Minimum Input Edge Rate: $V_{IN}$ from 0.8V to 2.0V, $V_{CC}$ @ 4.5V, 5.5V	125mV/ns

## DC Electrical Characteristics

Symbol	Parameter	V <sub>CC</sub> (V)	Conditions	T <sub>A</sub> = +25°C		T <sub>A</sub> = -40°C to +85°C		Units	
				Typ.	Guaranteed Limits				
V <sub>IH</sub>	Minimum HIGH Level Input Voltage	4.5	V <sub>OUT</sub> = 0.1V or V <sub>CC</sub> - 0.1V	1.5	2.0	2.0		V	
		5.5		1.5	2.0	2.0			
V <sub>IL</sub>	Maximum LOW Level Input Voltage	4.5	V <sub>OUT</sub> = 0.1V or V <sub>CC</sub> - 0.1V	1.5	0.8	0.8		V	
		5.5		1.5	0.8	0.8			
V <sub>OH</sub>	Minimum HIGH Level Output Voltage	4.5	I <sub>OUT</sub> = -50μA	4.49	4.4	4.4		V	
		5.5		5.49	5.4	5.4			
		4.5	V <sub>IN</sub> = V <sub>IL</sub> or V <sub>IH</sub> : I <sub>OH</sub> = -24mA			3.86	3.76		
		5.5	I <sub>OH</sub> = -24mA <sup>(1)</sup>			4.86	4.76		
V <sub>OL</sub>	Maximum LOW Level Output Voltage	4.5	I <sub>OUT</sub> = 50μA	0.001	0.1	0.1		V	
		5.5		0.001	0.1	0.1			
		4.5	V <sub>IN</sub> = V <sub>IL</sub> or V <sub>IH</sub> : I <sub>OL</sub> = 24mA			0.36	0.44		
		5.5	I <sub>OL</sub> = 24mA <sup>(1)</sup>			0.36	0.44		
I <sub>IN</sub>	Maximum Input Leakage Current	5.5	V <sub>I</sub> = V <sub>CC</sub> , GND		±0.1	±1.0		μA	
I <sub>CC</sub> T	Maximum I <sub>CC</sub> /Input	5.5	V <sub>I</sub> = V <sub>CC</sub> - 2.1V	0.6		1.5		mA	
I <sub>OLD</sub>	Minimum Dynamic Output Current <sup>(2)</sup>	5.5	V <sub>OLD</sub> = 1.65V Max.			75		mA	
		5.5	V <sub>OHD</sub> = 3.85V Min.			-75		mA	
I <sub>CC</sub>	Maximum Quiescent Supply Current	5.5	V <sub>IN</sub> = V <sub>CC</sub> or GND		2.0	20.0		μA	
V <sub>OLP</sub>	Quiet Output Maximum Dynamic V <sub>OL</sub>	5.0	Figures 1 & 2 <sup>(3)</sup>	1.1	1.5			V	
V <sub>OLV</sub>	Quiet Output Minimum Dynamic V <sub>OL</sub>	5.0	Figures 1 & 2 <sup>(3)</sup>	-0.6	-1.2			V	
V <sub>IHD</sub>	Minimum HIGH Level Dynamic Input Voltage	5.0	<sup>(4)</sup>	1.9	2.2			V	
V <sub>ILD</sub>	Maximum LOW Level Dynamic Input Voltage	5.0	<sup>(4)</sup>	1.2	0.8			V	

**Notes:**

1. All outputs loaded; thresholds on input associated with output under test.
2. Maximum test duration 2.0ms, one output loaded at a time.
3. Max number of outputs defined as (n). Data inputs are 0V to 3V. One output @ GND.
4. Max number of data inputs (n) switching. (n-1) inputs switching 0V to 3V. Input-under-test switching: 3V to threshold (V<sub>ILD</sub>), 0V to threshold (V<sub>IHD</sub>), f = 1MHz.

## AC Electrical Characteristics

Symbol	Parameter	V <sub>CC</sub> (V) <sup>(5)</sup>	T <sub>A</sub> = +25°C, C <sub>L</sub> = 50pF			T <sub>A</sub> = -40°C to +85°C, C <sub>L</sub> = 50pF		Units
			Min.	Typ.	Max.	Min.	Max.	
t <sub>PLH</sub>	Propagation Delay, Data to Output	5.0	2.0		7.5	2.0	8.0	ns
t <sub>PHL</sub>	Propagation Delay, Data to Output	5.0	2.0		7.5	2.0	8.0	ns
t <sub>OSHL</sub> , t <sub>OSLH</sub>	Output to Output Skew <sup>(6)</sup>	5.0		0.5	1.0		1.0	ns

### Notes:

- Voltage range 5.0 is 5.0V ± 0.5V.
- Skew is defined as the absolute value of the difference between the actual propagation delay for any two separate outputs of the same device. The specification applies to any outputs switching in the same direction, either HIGH-to-LOW (t<sub>OSHL</sub>) or LOW-to-HIGH (t<sub>OSLH</sub>). Parameter guaranteed by design.

## Capacitance

Symbol	Parameter	Conditions	Typ.	Units
C <sub>IN</sub>	Input Capacitance	V <sub>CC</sub> = OPEN	4.5	pF
C <sub>PD</sub>	Power Dissipation Capacitance	V <sub>CC</sub> = 5.0V	74	pF

## FACT™ Noise Characteristics

The setup of a noise characteristics measurement is critical to the accuracy and repeatability of the tests. The following is a brief description of the setup used to measure the noise characteristics of FACT.

### Equipment:

Hewlett Packard Model 8180A Word Generator  
 PC-163A Test Fixture  
 Tektronics Model 7854 Oscilloscope

### Procedure:

1. Verify Test Fixture Loading: Standard Load 50pF, 500Ω.
2. Deskew the HFS generator so that no two channels have greater than 150ps skew between them. This requires that the oscilloscope be deskewed first. It is important to deskew the word generator channels before testing. This will ensure that the outputs switch simultaneously.
3. Terminate all inputs and outputs to ensure proper loading of the outputs and that the input levels are at the correct voltage.
4. Set the HFS generator to toggle all but one output at a frequency of 1MHz. Greater frequencies will increase DUT heating and effect the results of the measurement.
5. Set the HFS generator input levels at 0V LOW and 3V HIGH for ACT devices and 0V LOW and 5V HIGH for AC devices. Verify levels with an oscilloscope.

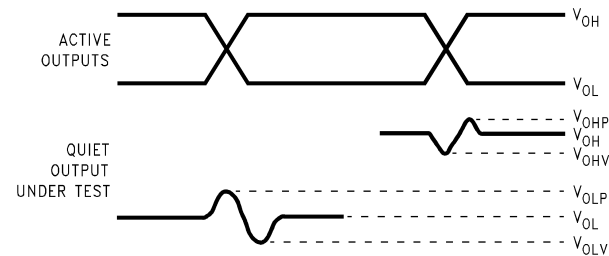

### Notes:

7.  $V_{OHV}$  and  $V_{OLP}$  are measured with respect to ground reference.
8. Input pulses have the following characteristics:  
 $f = 1\text{MHz}$ ,  $t_r = 3\text{ns}$ ,  $t_f = 3\text{ns}$ , skew < 150ps.

Figure 1. Quiet Output Noise Voltage Waveforms

### $V_{OLP}/V_{OLV}$ and $V_{OHP}/V_{OHV}$ :

- Determine the quiet output pin that demonstrates the greatest noise levels. The worst case pin will usually be the furthest from the ground pin. Monitor the output voltages using a 50Ω coaxial cable plugged into a standard SMB type connector on the test fixture. Do not use an active FET probe.
- Measure  $V_{OLP}$  and  $V_{OLV}$  on the quiet output during the worst case transition for active and enable. Measure  $V_{OHP}$  and  $V_{OHV}$  on the quiet output during the worst case active and enable transition.
- Verify that the GND reference recorded on the oscilloscope has not drifted to ensure the accuracy and repeatability of the measurements.

### $V_{ILD}$ and $V_{IHD}$ :

- Monitor one of the switching outputs using a 50Ω coaxial cable plugged into a standard SMB type connector on the test fixture. Do not use an active FET probe.
- First increase the input LOW voltage level,  $V_{IL}$ , until the output begins to oscillate or steps out a min of 2ns. Oscillation is defined as noise on the output LOW level that exceeds  $V_{IL}$  limits, or on output HIGH levels that exceed  $V_{IH}$  limits. The input LOW voltage level at which oscillation occurs is defined as  $V_{ILD}$ .
- Next decrease the input HIGH voltage level,  $V_{IH}$  until the output begins to oscillate or steps out a min of 2ns. Oscillation is defined as noise on the output LOW level that exceeds  $V_{IL}$  limits, or on output HIGH levels that exceed  $V_{IH}$  limits. The input HIGH voltage level at which oscillation occurs is defined as  $V_{IHD}$ .
- Verify that the GND reference recorded on the oscilloscope has not drifted to ensure the accuracy and repeatability of the measurements.

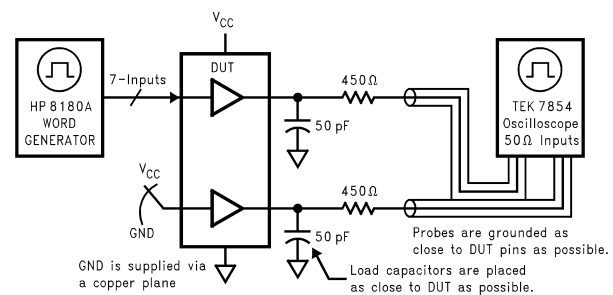
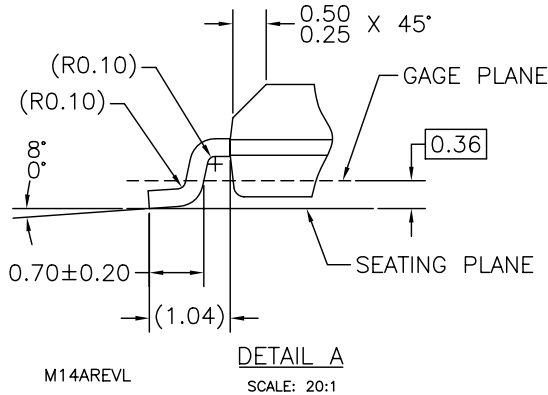
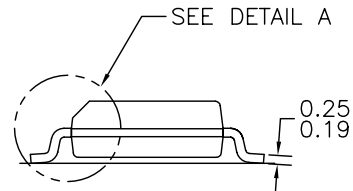
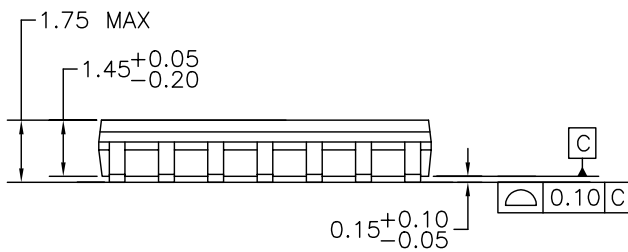
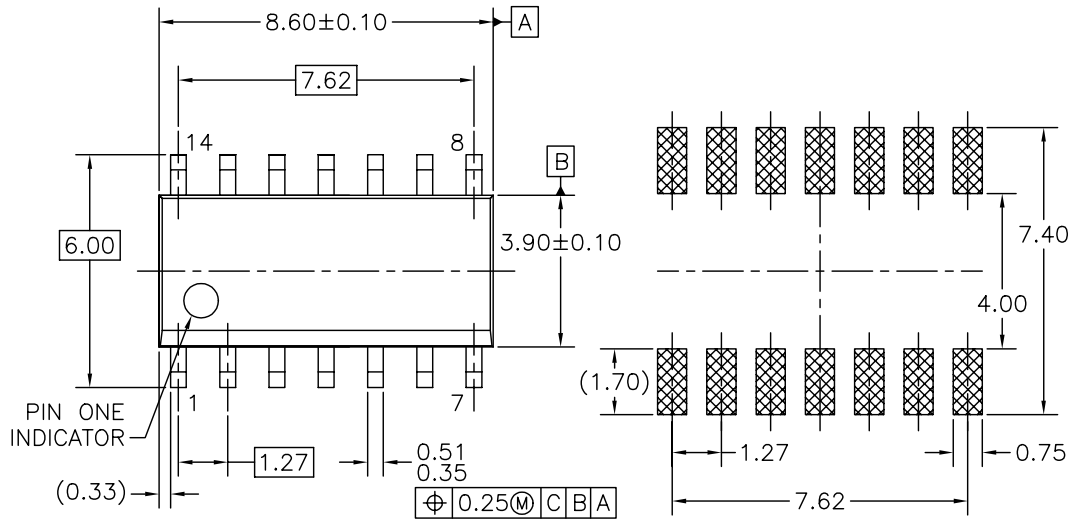

Figure 2. Simultaneous Switching Test Circuit

### Physical Dimensions

Dimensions are in millimeters unless otherwise noted.



NOTES: UNLESS OTHERWISE SPECIFIED

- A) THIS PACKAGE CONFORMS TO JEDEC MS-012, VARIATION AB, ISSUE C, DATED MAY 1990.
- B) ALL DIMENSIONS ARE IN MILLIMETERS.
- C) DIMENSIONS DO NOT INCLUDE MOLD FLASH OR BURRS.

**Figure 3. 14-Lead Small Outline Integrated Circuit (SOIC), JEDEC MS-012, 0.150" Narrow Package Number M14A**

**Physical Dimensions** (Continued)

Dimensions are in millimeters unless otherwise noted.

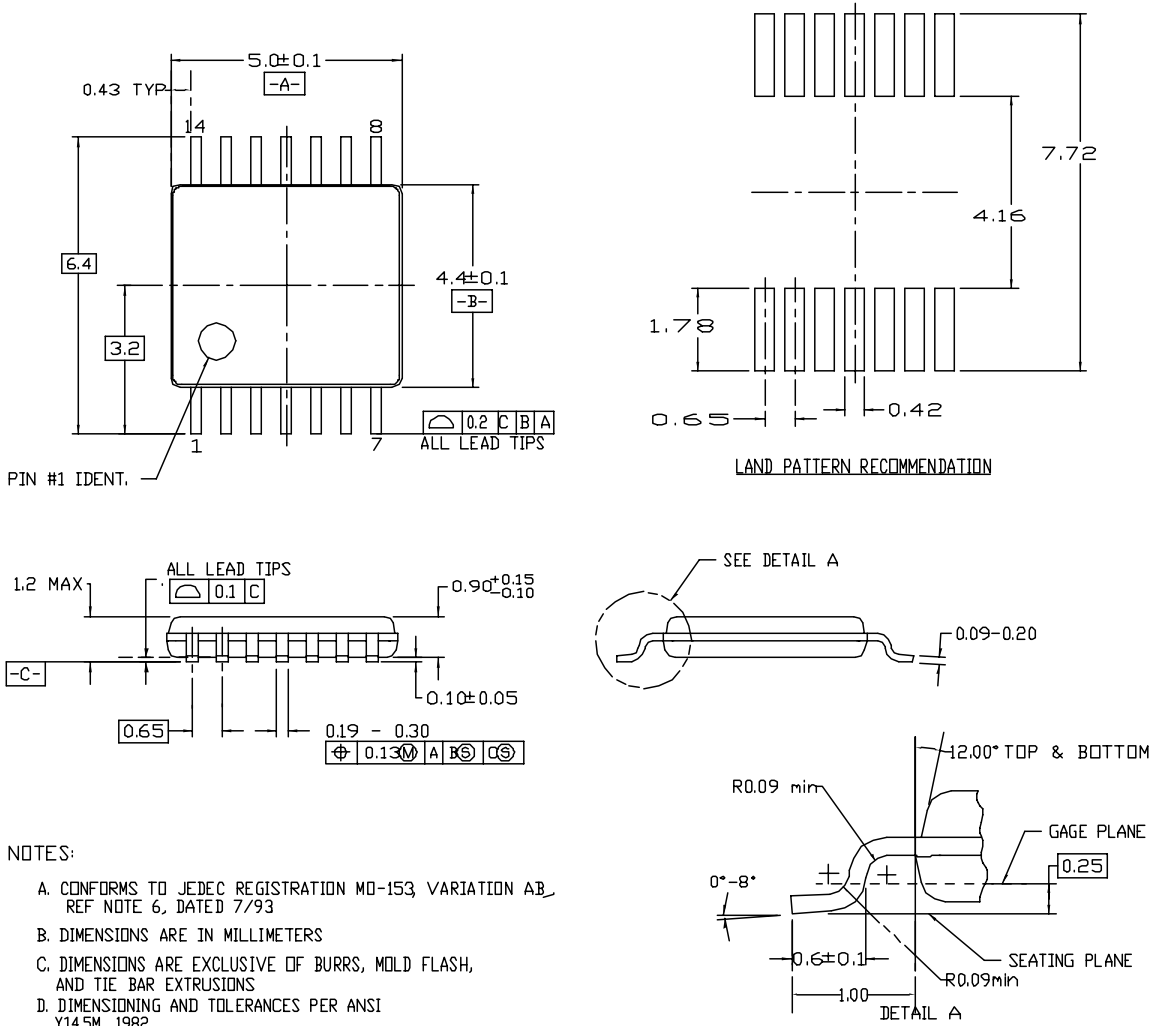

NOTES:

- A. CONFORMS TO JEDEC REGISTRATION MO-153, VARIATION AB, REF NOTE 6, DATED 7/93
- B. DIMENSIONS ARE IN MILLIMETERS
- C. DIMENSIONS ARE EXCLUSIVE OF BURRS, MOLD FLASH, AND TIE BAR EXTRUSIONS
- D. DIMENSIONING AND TOLERANCES PER ANSI Y14.5M, 1982

MTC14revD

**Figure 4. 14-Lead Thin Shrink Small Outline Package (TSSOP), JEDEC MO-153, 4.4mm Wide Package Number MTC14**



## TRADEMARKS

The following are registered and unregistered trademarks Fairchild Semiconductor owns or is authorized to use and is not intended to be an exhaustive list of all such trademarks.

ACEx <sup>®</sup>	<i>i-Lo</i> <sup>™</sup>	Power-SPM <sup>™</sup>	TinyBoost <sup>™</sup>
Across the board. Around the world. <sup>™</sup>	ImpliedDisconnect <sup>™</sup>	PowerTrench <sup>®</sup>	TinyBuck <sup>™</sup>
ActiveArray <sup>™</sup>	IntelliMAX <sup>™</sup>	Programmable Active Droop <sup>™</sup>	TinyLogic <sup>®</sup>
Bottomless <sup>™</sup>	ISOPLANAR <sup>™</sup>	QFET <sup>®</sup>	TINYOPTO <sup>™</sup>
Build it Now <sup>™</sup>	MICROCOUPLER <sup>™</sup>	QS <sup>™</sup>	TinyPower <sup>™</sup>
CoolFET <sup>™</sup>	MicroPak <sup>™</sup>	QT Optoelectronics <sup>™</sup>	TinyWire <sup>™</sup>
CROSSVOLT <sup>™</sup>	MICROWIRE <sup>™</sup>	Quiet Series <sup>™</sup>	TruTranslation <sup>™</sup>
CTL <sup>™</sup>	Motion-SPM <sup>™</sup>	RapidConfigure <sup>™</sup>	SerDes <sup>™</sup>
Current Transfer Logic <sup>™</sup>	MSX <sup>™</sup>	RapidConnect <sup>™</sup>	UHC <sup>®</sup>
DOME <sup>™</sup>	MSXPro <sup>™</sup>	ScalarPump <sup>™</sup>	UniFET <sup>™</sup>
E <sup>2</sup> CMOS <sup>™</sup>	OCX <sup>™</sup>	SMART START <sup>™</sup>	VCX <sup>™</sup>
EcoSPARK <sup>®</sup>	OCXPro <sup>™</sup>	SPM <sup>®</sup>	Wire <sup>™</sup>
EnSigna <sup>™</sup>	OPTOLOGIC <sup>®</sup>	STEALTH <sup>™</sup>	
FACT Quiet Series <sup>™</sup>	OPTOPLANAR <sup>®</sup>	SuperFET <sup>™</sup>	
FACT <sup>®</sup>	PACMAN <sup>™</sup>	SuperSOT <sup>™</sup> -3	
FAST <sup>®</sup>	PDP-SPM <sup>™</sup>	SuperSOT <sup>™</sup> -6	
FASTr <sup>™</sup>	POP <sup>™</sup>	SuperSOT <sup>™</sup> -8	
FPS <sup>™</sup>	Power220 <sup>®</sup>	SyncFET <sup>™</sup>	
FRFET <sup>®</sup>	Power247 <sup>®</sup>	TCM <sup>™</sup>	
GlobalOptoisolator <sup>™</sup>	PowerEdge <sup>™</sup>	The Power Franchise <sup>®</sup>	
GTO <sup>™</sup>	PowerSaver <sup>™</sup>		
HiSeC <sup>™</sup>			

## DISCLAIMER

FAIRCHILD SEMICONDUCTOR RESERVES THE RIGHT TO MAKE CHANGES WITHOUT FURTHER NOTICE TO ANY PRODUCTS HEREIN TO IMPROVE RELIABILITY, FUNCTION OR DESIGN. FAIRCHILD DOES NOT ASSUME ANY LIABILITY ARISING OUT OF THE APPLICATION OR USE OF ANY PRODUCT OR CIRCUIT DESCRIBED HEREIN; NEITHER DOES IT CONVEY ANY LICENSE UNDER ITS PATENT RIGHTS, NOR THE RIGHTS OF OTHERS. THESE SPECIFICATIONS DO NOT EXPAND THE TERMS OF FAIRCHILD'S WORLDWIDE TERMS AND CONDITIONS, SPECIFICALLY THE WARRANTY THEREIN, WHICH COVERS THESE PRODUCTS.

## LIFE SUPPORT POLICY

FAIRCHILD'S PRODUCTS ARE NOT AUTHORIZED FOR USE AS CRITICAL COMPONENTS IN LIFE SUPPORT DEVICES OR SYSTEMS WITHOUT THE EXPRESS WRITTEN APPROVAL OF FAIRCHILD SEMICONDUCTOR CORPORATION.

As used herein:

1. Life support devices or systems are devices or systems which, (a) are intended for surgical implant into the body or (b) support or sustain life, and (c) whose failure to perform when properly used in accordance with instructions for use provided in the labeling, can be reasonably expected to result in a significant injury of the user.
2. A critical component in any component of a life support, device, or system whose failure to perform can be reasonably expected to cause the failure of the life support device or system, or to affect its safety or effectiveness.

## PRODUCT STATUS DEFINITIONS

### Definition of Terms

Datasheet Identification	Product Status	Definition
Advance Information	Formative or In Design	This datasheet contains the design specifications for product development. Specifications may change in any manner without notice.
Preliminary	First Production	This datasheet contains preliminary data; supplementary data will be published at a later date. Fairchild Semiconductor reserves the right to make changes at any time without notice to improve design.
No Identification Needed	Full Production	This datasheet contains final specifications. Fairchild Semiconductor reserves the right to make changes at any time without notice to improve design.
Obsolete	Not In Production	This datasheet contains specifications on a product that has been discontinued by Fairchild Semiconductor. The datasheet is printed for reference information only.

Rev. 126