

Medical Grade AC/DC Power Supply With PFC

85-264Vrms Input Voltage	12/24/48V Fully Regulated Output	400W Output Continuous	500W Output Transient	Up to 91% Full Load Efficiency
------------------------------------	--	----------------------------------	---------------------------------	--

ACuQor®

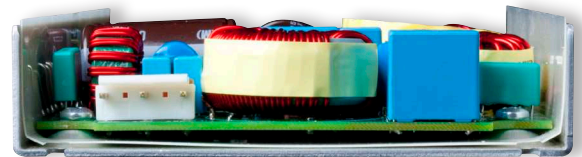
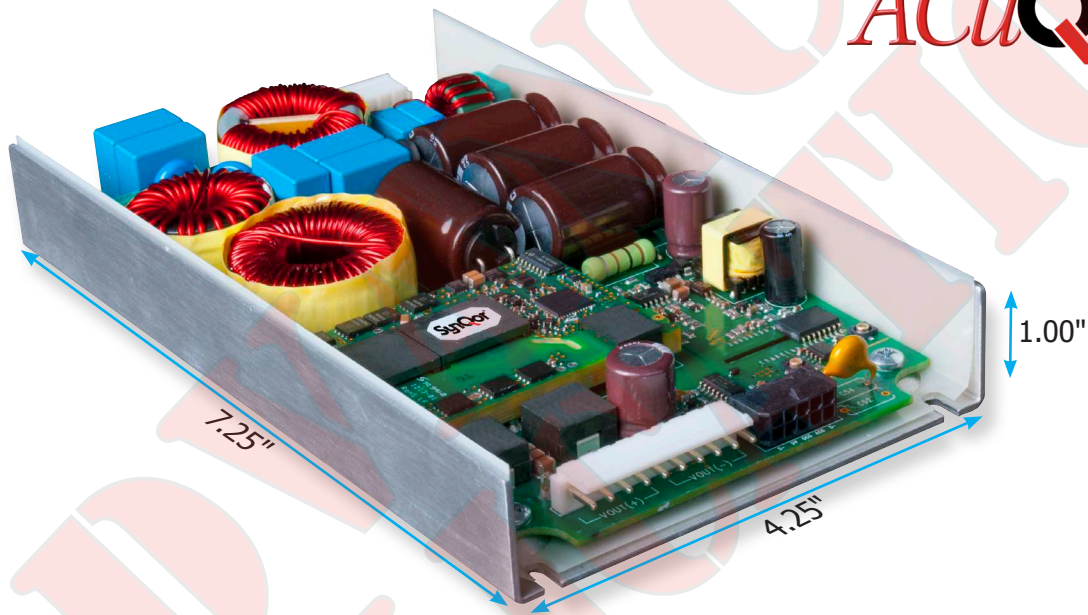

Product Features

- High efficiency (91% for 48Vout Model at 400W)
- Designed for high reliability and low cost
- Universal input voltage range (85-264 Vrms)
- Fully regulated output
- Active PFC; EN61000-3-2 compliant
- Low leakage; EN60601-1 compliant
- Low noise; EN55011 / EN55022 Class B compliant
- Conduction cooled - no internal fan
- Over-current, over-voltage, and over-temp protection
- DC Power Good / AC Power Good signals
- Remote enable input (normally on/off selectable)
- Thin form factor 4.25" x 7.25" x 1"
- RoHS 6/6 compliant
- 5 V (50mA) standby output

ACuQor 400W C Series Electrical Characteristics

All specifications typical with TA = 25 °C, unless otherwise specified.

MAIN OUTPUT SPECIFICATIONS			GENERAL SPECIFICATIONS		
Output power (continuous)	85-264 Vrms	400W	Fundamental ripple freq.	Input	90 kHz
(transient)	85-264 Vrms	500W		Output	90 kHz
Nominal DC output	12 Vout	12.0 V	Weight	All	567 g (20.0 oz)
voltage (at 400W)	24 Vout	24.0 V	ISOLATION SPECIFICATIONS		
(Fully-regulated)	48 Vout	48.0 V	Isolation voltage	Input to output	4000 Vrms
Efficiency (see figs. 1 - 10)	12 Vout, 115 Vrms, 400W	88% typ.		Input to ground	1500 Vrms
	24 Vout, 115 Vrms, 400W	90% typ.		Output to ground (BF)	1500 Vrms
	48 Vout, 115 Vrms, 400W	90% typ.	Insulation resistance	Output to ground	10 MΩ min.
	12 Vout, 230 Vrms, 400W	89% typ.	Leakage currents		See Note 2
	24 Vout, 230 Vrms, 400W	91% typ.	ENVIRONMENTAL CHARACTERISTICS		
	48 Vout, 230 Vrms, 400W	91% typ.	Thermal performance	Operating ambient (see Figure 11)	0 °C to +70 °C
Hold-up time	12 / 24 / 48 Vout	20 ms @ 400W		Non-operating ambient	-40 °C to +85 °C
Maximum load capacitance	12 Vout	16,000 μF	Relative humidity	Non-condensing	5-95% RH
	24 Vout	8,000 μF	Altitude	Operating	10,000 ft max.
	48 Vout	2,000 μF		Non-operating	30,000 ft max.
Output ripple voltage	Switching frequency (20 MHz BW)	0.6% p-p	Random vibration	5-500 Hz	0.03 g2/Hz
	Twice line frequency (at 400W)	5.0% p-p	Shock	Half-sine, 10 ms, 3 axes	20 g peak
Turn-on delay		2 s max.	EMC CHARACTERISTICS (preliminary)		
Transient response	Iout steps from 50-75%	4% typ / 6% max. dev.	Conducted emissions	EN55011 & EN55022, FCC part15	Level B
Overvoltage protection	Cyclic restart	110-120%	Line frequency harmonics	EN61000-3-2	Class A
Short circuit protection	Cyclic operation	130% rated Iout	Voltage fluctuations	EN61000-3-3	Clause 5b
Total regulation	Over line, load and temperature	±1.0%	ESD air	EN61000-4-2	Level 3
Auxiliary Output	Always on (See Note 1)	5 V @ 50 mA	ESD contact	EN61000-4-2	Level 3
Thermal protection	Automatic recovery	+130°C (PCB Temp)	Radiated immunity	EN61000-4-3	Level 3
REMOTE_ENABLE	Input Low Voltage	0.45 V (max)	Fast transients	EN61000-4-4	Level 3
	Input High Voltage	4.15 V (min)	Line surge immunity	EN61000-4-5	Level 3
INPUT SPECIFICATIONS			Conducted immunity	EN61000-4-6	Level 3
AC input voltage	Universal range	85-264 Vrms	Power freq. mag. field	EN61000-4-8	3 A/m
Input frequency		47-63 Hz	Voltage dip immunity	EN61000-4-11	Perf Criteria A, A, B
Input current	115 Vrms @ 400W	4 Arms			<5% UT 10 ms, 70% UT 500 ms, 40% UT 100 ms
	230 Vrms @ 400W	2 Arms	NOTES:		
Power factor		>0.98	1. Derate 2 mA per °C above 50 °C ambient temperature.		
Input surge current	85-264 Vrms	2 A max.	2. Leakage currents see page 4.		
Internal input fuses	Both AC lines	6.3 A			

SAFETY AGENCY CERTIFICATIONS - Pending

ANSI/AAMI ES60601-1:2005
 CAN/CSA-C22.2 No. 60601-1-08
 EN 60601-1:2006
 IEC 60601-1:2005
 CE Marked

EFFICIENCY, DERATING, AND POWER DISSIPATION CURVES

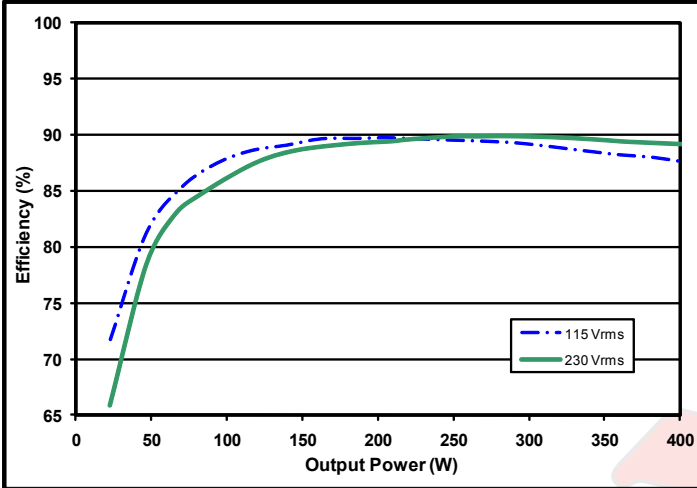

Figure 1: 12 VOUT efficiency curves.

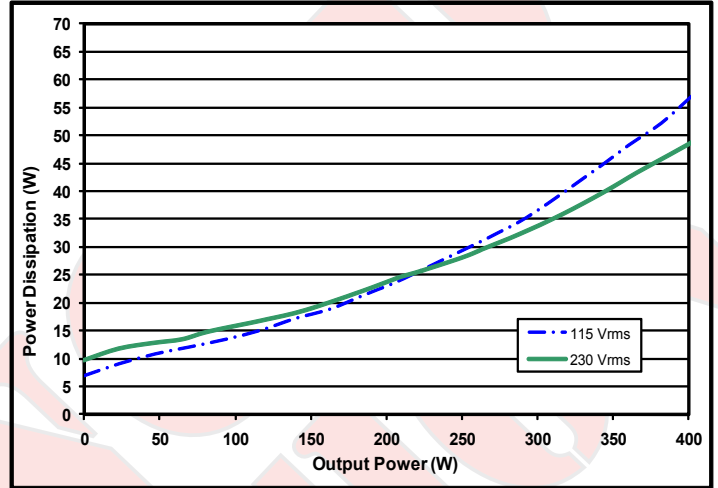

Figure 2: 12 VOUT power dissipation.

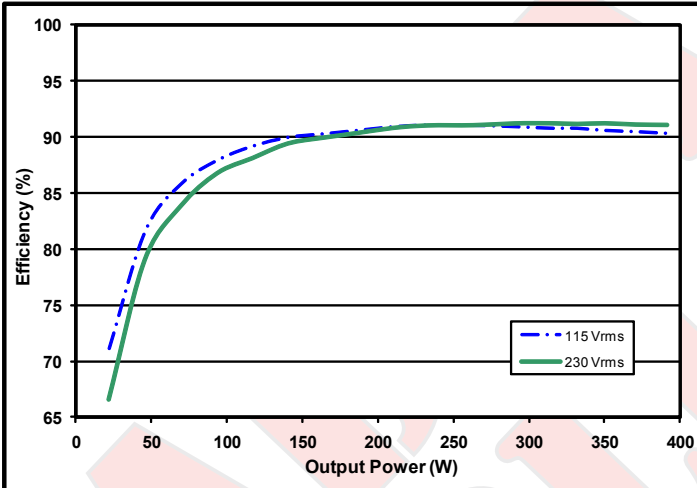

Figure 3: 24 VOUT efficiency curves.

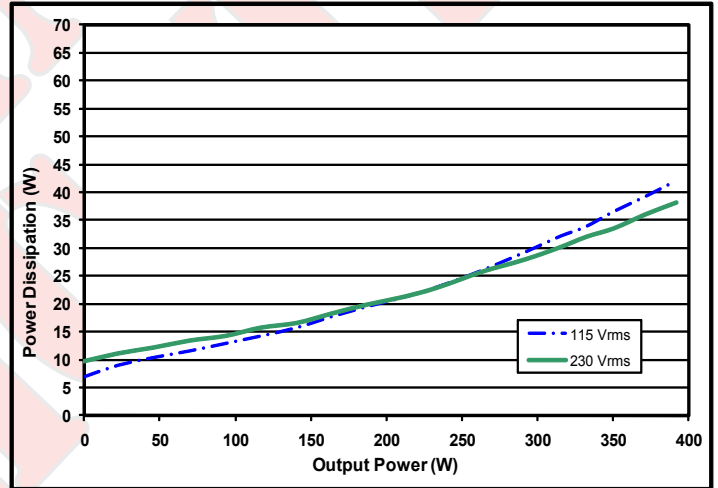

Figure 4: 24 VOUT power dissipation..

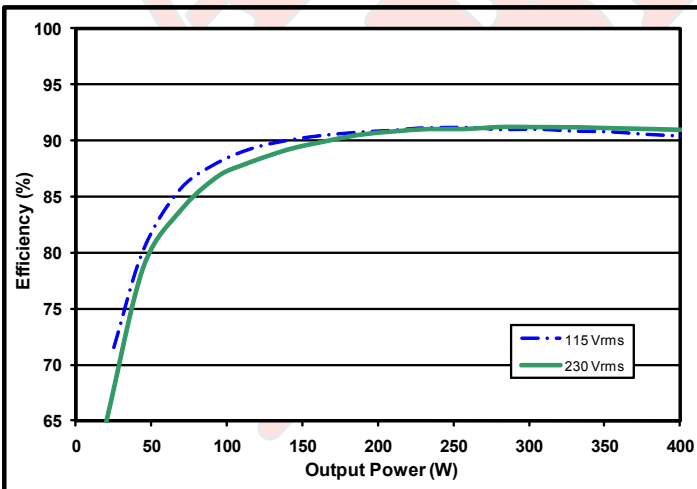

Figure 5: 48 VOUT efficiency curves.

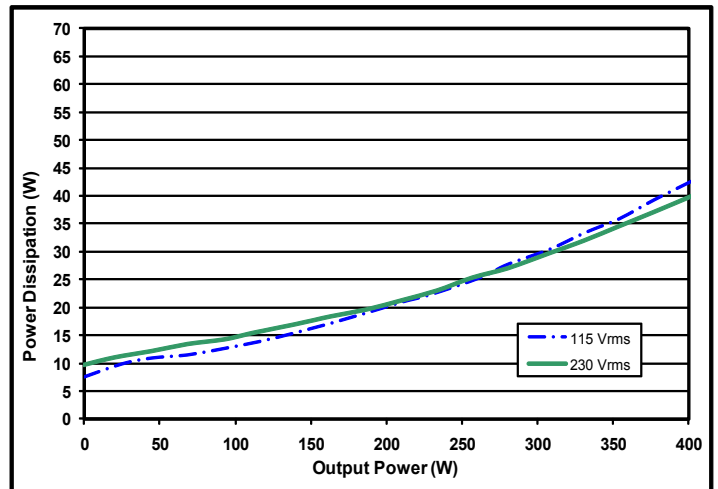

Figure 6: 48 VOUT power dissipation

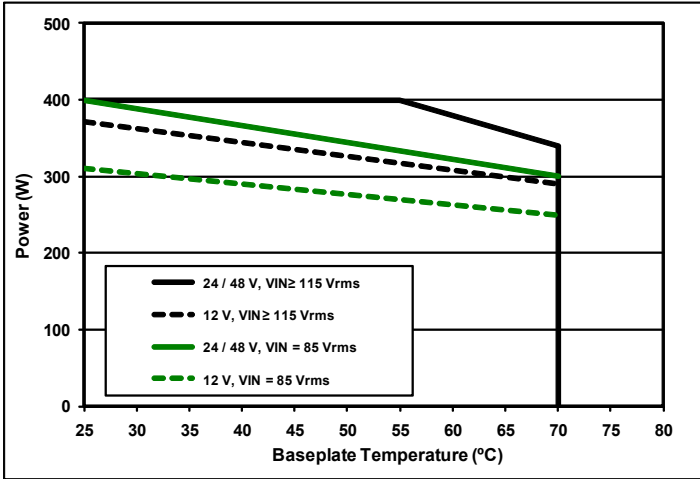

Figure 7: Continuous power derating curve for conduction cooling through flat side of chassis, with only natural convection air cooling.

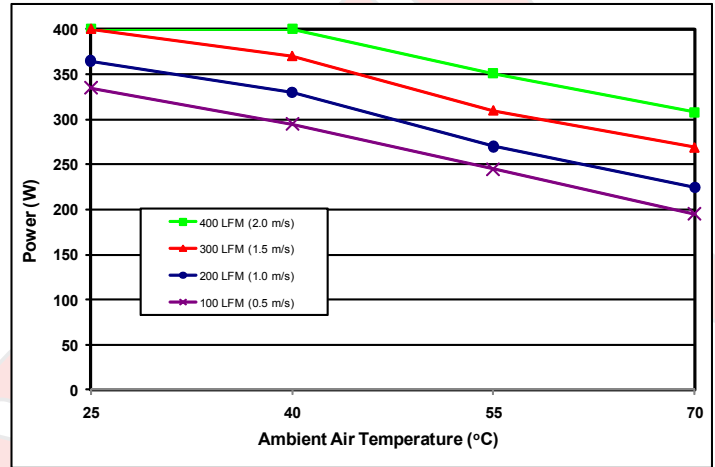

Figure 8: Power derating curves vs. ambient air temperature for airflow rates of 100 LFM through 400 LFM, with no conduction cooling.

AC Leakage Current from Input to Earth	AC Line Connection	Normal Condition	Open Neutral Fault
ACuQor Typical at 110% nominal input voltage 60 Hz	240 V L-N, 1 phase	330 μ A	540 μ A
	208 V L-L, 120 V L-N, 1 of 3 phases	165 μ A	270 μ A
	240 V L-N-L, 120 V L-N, split phase	165 μ A	270 μ A

For convenience, the following tables show limits allowed by various standards:

AC Leakage Current from Input to Earth	Standard	Normal Condition	Open Neutral Fault
Maximum Allowed per Standard	IEC60601-1	500 μ A	1000 μ A
	IEC60950	3500 μ A	—

AC Leakage Current from Output to Earth	Model	Normal Condition	Open Earth Fault	AC Backdrive Fault
ACuQor Typical at 264 Vac 60 Hz input	AQ . . BF . .	30 μ A	75 μ A	170 μ A

AC Leakage Current from Output to Earth	Contact Type	Normal Condition	Open Earth Fault	AC Backdrive Fault
Maximum Allowed per IEC60601-1	BF	100 μ A	500 μ A	5000 μ A

Table 1: Leakage Currents

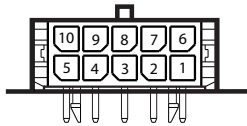

OUTPUT CONTROL CONNECTOR PINOUT

Pin 1	SEC_GND	Ground return for 5V_STANDBY and all control signals. Tied internally to pin 5.
Pin 2	AC_POWER_GOOD	Open collector output with internal 5 V pull-up. See Figure A. Pulled low on AC power dropout.
Pin 3	DC_POWER_GOOD	Open collector output with internal 5 V pull-up. See Figure A. Pulled low during startup ramp and within 5°C of temperature shutdown threshold.
Pin 4	5V_STANDBY	5 V @ 50 mA available whenever AC power is applied.
Pin 5	SENSE(-)	Negative remote sense. Internal 10 Ω resistor to VOUT(-) allows unit to operate normally if pin left open. Tied internally to Pin 1.
Pin 6	Reserved	Reserved - leave open
Pin 7	Reserved	Reserved - leave open
Pin 8	REMOTE_ENABLE	Logic input turns unit on when high. Internal 5 V pull-up will enable unit by default if pin left open. See Figures B and C.
Pin 9	ENABLE_PULLUP	Internally connected to midpoint of pin 8 pull-up. Leave open for normal operation. See Figures B and C.
Pin 10	SENSE(+)	Positive remote sense. Internal 100 Ω resistor to VOUT(+) allows unit to operate normally if pin left open.

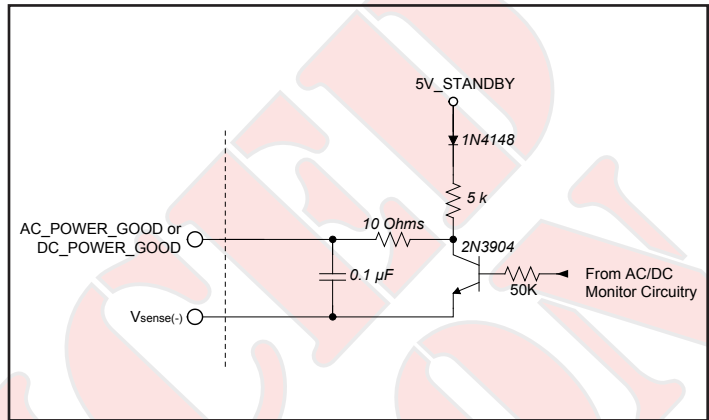

Figure A: AC and DC_POWER_GOOD interface circuitry.

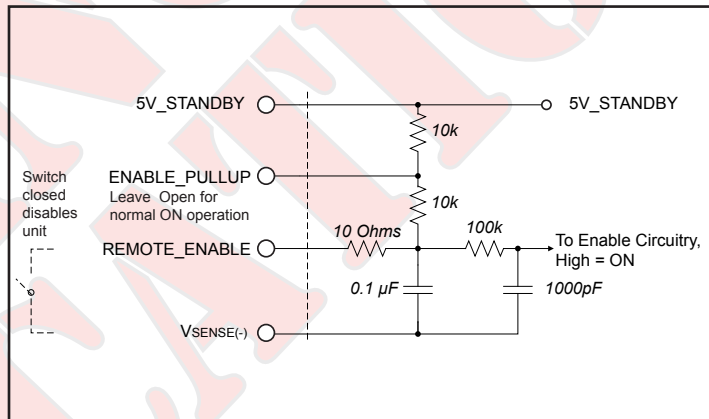
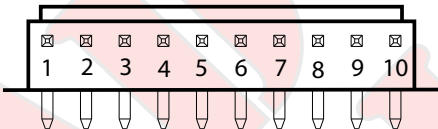

Figure B: Remote enable interface circuitry for normally ON operation.



OUTPUT POWER CONNECTOR PINOUT

Pin 1	VOUT(+)	Positive Output Voltage
Pin 2	VOUT(+)	Positive Output Voltage
Pin 3	VOUT(+)	Positive Output Voltage
Pin 4	VOUT(+)	Positive Output Voltage
Pin 5	VOUT(+)	Positive Output Voltage
Pin 6	VOUT(-)	Negative Output Voltage
Pin 7	VOUT(-)	Negative Output Voltage
Pin 8	VOUT(-)	Negative Output Voltage
Pin 9	VOUT(-)	Negative Output Voltage
Pin 10	VOUT(-)	Negative Output Voltage

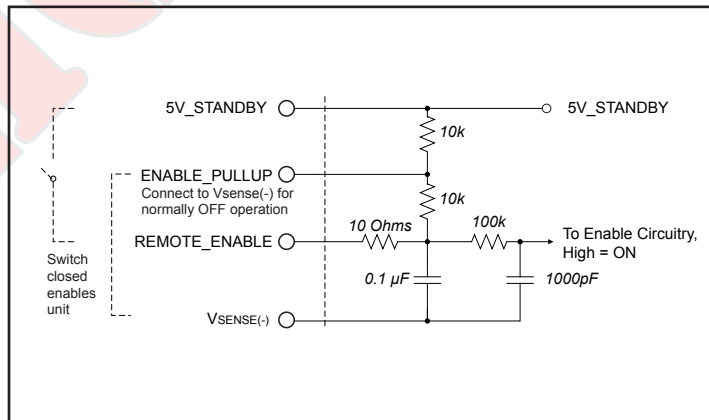
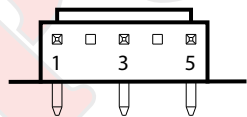

Figure C: Remote enable interface circuitry for normally OFF operation.



INPUT CONNECTOR PINOUT

Pin 1	Ground
Pin 3	AC Neutral
Pin 5	AC Line

MATING CONNECTORS

Connector	Type	Contact
OUTPUT (Power)	JST VHR-10N	JST SVH-41T-P1.1
OUTPUT (Control)	Würth 662 010 113 322 Tyco Elect 1-794617-0 Molex 43025-1000	Würth 662 001 137 22 Tyco Elect 794606-1 Molex 43030-0001
INPUT	JST VHR-5N	JST SVH-41T-P1.1

MECHANICAL DRAWINGS

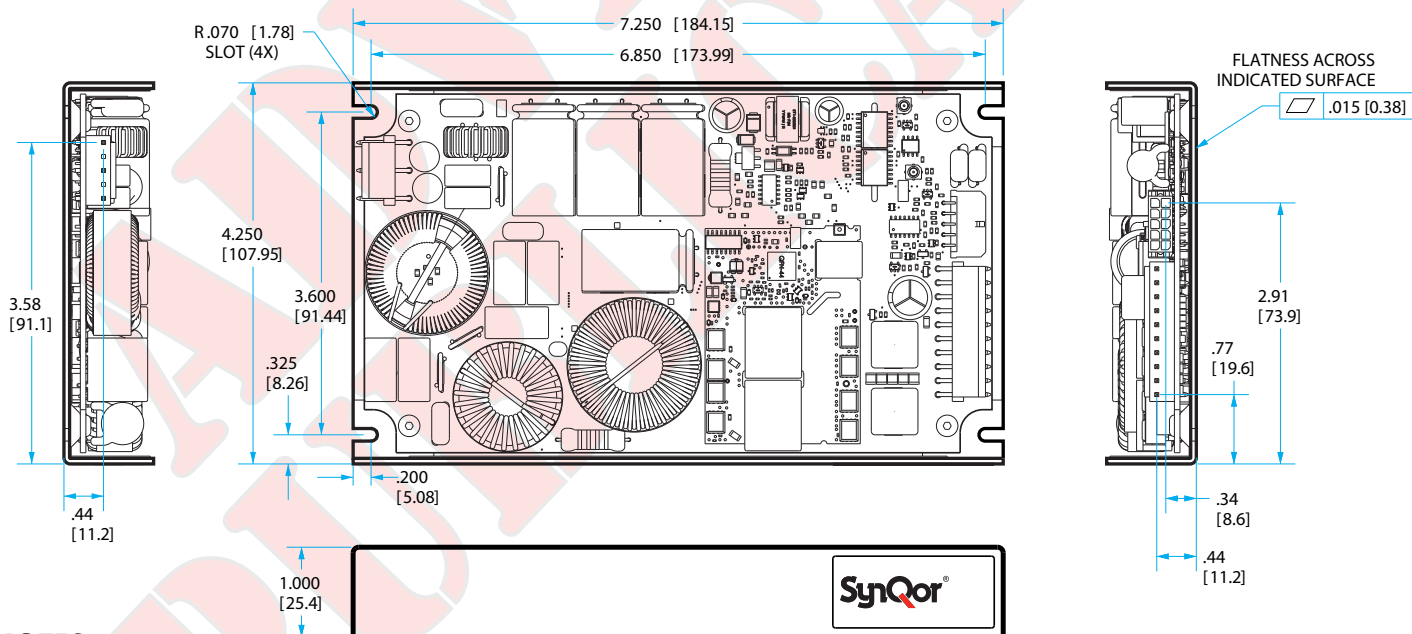
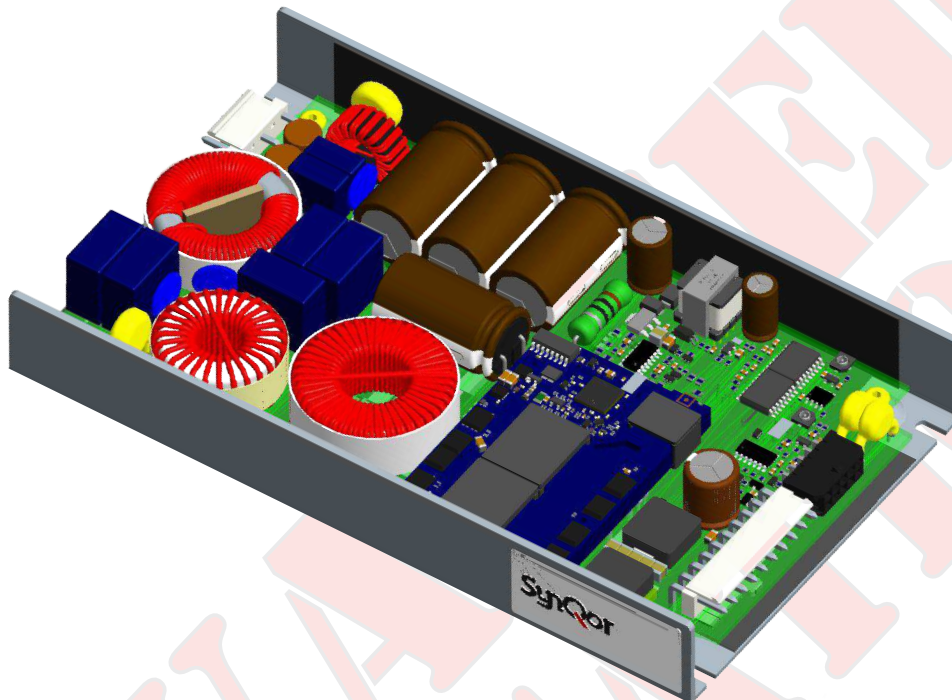

NOTES

1. Recommended screw tightening torque of 6in. lbs
2. Undimensioned components are shown for visual reference only
3. All dimensions in inches [mm]
 Tolerances: x.xx in ± 0.02
 x.xxx in ± 0.010

INSTALLATION INSTRUCTIONS

GENERAL: ACuQor power supplies are intended for use as components in medical and industrial equipment. ACuQor units must be properly installed within end use equipment before they can be safely applied as described in this document. The suitability of the ACuQor/equipment combination must be verified through end product investigation.

THERMAL: In the interest of high reliability, this unit has no on-board fan. An external means of cooling is necessary to stay within the bounds of the power derating curves. The unit is designed to transfer heat directly to the flat bottom of the chassis, so the end use equipment should be designed to use conduction cooling. The thermal resistance of the mounting point to ambient will be the critical factor determining baseplate temperature. Conduction cooling may be supplemented by forced air cooling, further improving performance at high ambient temperatures.

MOUNTING: Refer to the Mechanical Drawings section. Four mounting points are provided near the corners of the chassis. Any orientation (vertical, horizontal, etc.) may be used. The chassis is internally connected to the input connector protective-earth terminal for functional-earth EMC control. This unit is designed for a pollution degree 2 environment.

INPUT: Refer to the Connector Details section for input connector wiring. ACuQor products require a single phase AC power source of 100-240V 50/60Hz nominal. Refer to nameplate label for input current ratings. A protective-earth connection is also required. Minimum wire size of 18 AWG (0.8mm²) is recommended. Both sides of the AC line are internally fused (see table for specific models). These fuses are not user replaceable.

OUTPUT: Refer to the Connector Details section for output connector wiring and signal I/O functionality. Refer to nameplate label for output current ratings. Main DC output (Vout+, Vout-) pins should use 16 AWG (1.3mm²) wire size. Individual main output pins should not be loaded to more than 10 A. For currents greater than 10 A, multiple main output pins/wires must be used in parallel. All signal I/O pins are referenced to SENSE(-).

EMC: ACuQor products have been tested to the EMC specifications listed in the section of this datasheet titled Electrical Characteristics, on page two. However, end use equipment must be tested to verify EMC compliance.

PATIENT CONTACT: ACuQor models include versions designed for B and BF patient contact application per IEC60601-1. The BF ACuQor model provides reinforced insulation at the DC output voltage level and basic insulation at the 240 Vac level from output to protective-earth. Note that equipment and wiring may add to system leakage currents so that the end product must be tested for compliance. Refer to the Electrical Characteristics section for typical ACuQor input and output leakage currents.

HIPOT TESTING: ACuQor products are rated for Hipot testing levels of 1500 Vac input to protective-earth, 1500 Vac output to protective-earth, and 4000 Vac input to output. When performing the 4000 Vac input to output test, the test voltage must be balanced evenly 2000 Vac input and output to protective-earth. Two oppositely phased test voltage sources or a single test voltage source with external balancing impedances (capacitors) may be used to prevent overstressing input or output to protective-earth insulation per IEC60601-1 2005 sub clause 8.8.1 and IEC60601-1 1990 sub clause 20.4.

MODEL	Input Fuses (in Both AC Lines)	Fuses Total
AQ0400	Littelfuse 373 Series 250V 6.3A or Belfuse Type MRF 250V 6.3A	2

Table 2: Internal AC line fuses

PART NUMBERING SYSTEM

The part numbering system for SynQor's ACuQor AC/DC power supplies follows the format shown in the table below. Not all combinations make valid part numbers, please contact SynQor for availability.

Family	Output Power	Grade	Range	Output Voltage	Package Type	Thermal Design	Options
AQ: ACuQor series of AC-DC semi-regulated output power supplies	0400: 400W	M: (Medical) I: (Industrial)	U: Universal (85-264 VRMS)	12: 12V 24: 24V 48: 48V	C: 1 unit (4.25"x7.25")	U: U Channel Conduction Cooled	Medical Grade BF: BF isolation rating Industrial Grade IND: Industrial

Example: AQ0400MUxxCUxx

ACCESSORIES

SynQor offers a series of assemblies that can be ordered according to the table below. Mechanical drawings for these accessories are available for download in pdf format from the SynQor website.

Part Number	Description
AQ-CBL-INPUT1C	Input mating cable with pre-stripped wire ends (36" long)
AQ-CBL-OUT1CDC	Output mating cables (Power and Control) with pre-stripped wire ends (18" long)

APPLICATION NOTES

A variety of application notes and technical white papers can be downloaded in pdf format from the SynQor website.

[Online Application Notes](#)
[Online Library of Technical White Papers](#)
[SynQor website.](#)

PATENTS

SynQor holds the following U.S. patents, one or more of which apply to each product listed in this document. Additional patent applications may be pending or filed in the future.

5,999,417	6,222,742	6,545,890	6,577,109	6,594,159	6,731,520
6,894,468	6,896,526	6,927,987	7,050,309	7,072,190	7,085,146
7,119,524	7,269,034	7,272,021	7,272,023	7,558,083	7,564,702
7,765,687	7,787,261	8,023,290	8,149,597		

Contact SynQor for further information:

Phone: **978-849-0600**
Toll Free: **888-567-9596**
Fax: **978-849-0602**
E-mail: **power@synqor.com**
Web: **www.synqor.com**
Address: **155 Swanson Road**
Boxborough, MA 01719
USA

Warranty

SynQor offers a three (3) year limited warranty. Complete warranty information is listed on our website or is available upon request from SynQor.

Information furnished by SynQor is believed to be accurate and reliable. However, no responsibility is assumed by SynQor for its use, nor for any infringements of patents or other rights of third parties which may result from its use. No license is granted by implication or otherwise under any patent or patent rights of SynQor.