

9-75V Continuous Input	100V Transient Input	1.8-48V Outputs	126W Max Power	2250V dc Isolation	Half-brick DC-DC Converter
----------------------------------	--------------------------------	---------------------------	--------------------------	------------------------------	--------------------------------------

The InQor® Half-brick converter series is composed of next-generation, board-mountable, isolated, fixed switching frequency dc-dc converters that use synchronous rectification to achieve extremely high power conversion efficiency. Each module is supplied completely encased to provide protection from the harsh environments seen in many industrial and transportation applications.



Operational Features

- High efficiency, up to 88% at full rated load current
- Delivers full power with minimal derating - no heatsink required
- Operating input voltage range: 9-75V, 100V transient for 100ms
- Fixed frequency switching provides predictable EMI
- No minimum load requirement

Mechanical Features

- Industry standard Half-brick pin-out configuration
- Size: 2.386" x 2.486" x 0.512" (60.6 x 63.1 x 13.0 mm)
- Total weight: 4.9 oz (139 g)

Control Features

- On/Off control referenced to input side
- Remote sense for the output voltage
- Output voltage trim range of -20%, +10%

Safety Features

- 2250V input-to-output isolation
- UL 60950-1:2003 Basic Insulation
- CAN/CSA-C22.2 No. 60950-1:2003
- EN60950-1:2001
- RoHS compliant (see last page)

Protection Features

- Input under-voltage lockout
- Input over-voltage shutdown
- Output current limit and short circuit protection
- Active back bias limit
- Output over-voltage protection
- Thermal shutdown

CONTENTS

	Page No.
Family Electrical Characteristics	2
Electrical Characteristics (1.8 Vout) & Figures	4
Electrical Characteristics (3.3 Vout) & Figures	6
Electrical Characteristics (5.0 Vout) & Figures	8
Electrical Characteristics (12 Vout) & Figures	10
Electrical Characteristics (15 Vout) & Figures	12
Electrical Characteristics (24 Vout) & Figures	14
Electrical Characteristics (28 Vout) & Figures	16
Electrical Characteristics (40 Vout) & Figures	18
Electrical Characteristics (48 Vout) & Figures	20
Application Section	22
Standards & Qualification Testing	26
Standard Mechanical Diagram	27
Flanged Mechanical Diagram	28
Ordering Information	29

IQ32 FAMILY Electrical Characteristics (all output voltages)

Ta = 25 °C, airflow rate = 300 LFM, Vin = 32V dc unless otherwise noted; full operating temperature range is -40 °C to +100 °C baseplate temperature with appropriate power derating. Specifications subject to change without notice.

Parameter	Min.	Typ.	Max.	Units	Notes & Conditions
ABSOLUTE MAXIMUM RATINGS					
Input Voltage					
Non-Operating			100	V	Continuous
Operating			75	V	Continuous
Operating Transient Protection			100	V	100 ms
Isolation Voltage					
Input to Output			2250	V dc	
Input to Base-Plate			2250	V dc	
Output to Base-Plate			2250	V dc	
Operating Temperature	-40		100	°C	Baseplate temperature
Storage Temperature	-55		125	°C	
Voltage at ON/OFF input pin	-2		18	V	
INPUT CHARACTERISTICS					
Operating Input Voltage Range	9	32	75	V	100V transient for 100 ms; See Note 1
Input Under-Voltage Lockout					
Turn-On Voltage Threshold	11.0	11.2	11.5	V	
Turn-Off Voltage Threshold	8.1	8.4	8.7	V	
Lockout Voltage Hysteresis		2.8		V	
Input Over-Voltage Shutdown		100		V	
Recommended External Input Capacitance		470		µF	Typical ESR 0.1-0.2 Ω
Input Filter Component Values (L\C)		0.34\13.2		µH\µF	Internal values; see Figure E
DYNAMIC CHARACTERISTICS					
Turn-On Transient					
Turn-On Time		10		ms	Full load, Vout=90% nom.
Start-Up Inhibit Time	200	230	250	ms	Figure F
Output Voltage Overshoot		0		%	Maximum Output Capacitance
ISOLATION CHARACTERISTICS					
Isolation Voltage (dielectric strength)					See Absolute Maximum Ratings
Isolation Resistance		30		MΩ	
Isolation Capacitance (input to output)		1000		pF	See Note 2
TEMPERATURE LIMITS FOR POWER DERATING CURVES					
Semiconductor Junction Temperature			125	°C	Package rated to 150 °C
Board Temperature			125	°C	UL rated max operating temp 130 °C
Transformer Temperature			125	°C	
Maximum Baseplate Temperature, Tb			100	°C	
FEATURE CHARACTERISTICS					
Switching Frequency	255	275	295	kHz	Isolation stage switching freq. is half this
ON/OFF Control					
Off-State Voltage	2.4		18	V	
On-State Voltage	-2		0.8		
ON/OFF Control					Application notes Figures A & B
Pull-Up Voltage		5		V	
Pull-Up Resistance		50		kΩ	
Over-Temperature Shutdown OTP Trip Point		125		°C	Average PCB Temperature
Over-Temperature Shutdown Restart Hysteresis		10		°C	
RELIABILITY CHARACTERISTICS					
Calculated MTBF (Telcordia) TR-NWT-000332		1.44		10 ⁶ Hrs.	Tb = 70°C
Calculated MTBF (MIL-217) MIL-HDBK-217F		1.20		10 ⁶ Hrs.	Tb = 70°C
Field Demonstrated MTBF				10 ⁶ Hrs.	See our website for details

Note 1: Start-up guaranteed above 11.5 V, but will operate down to 9V

Note 2: Higher values of isolation capacitance can be added external to the module.

Family Figures (all output voltages)

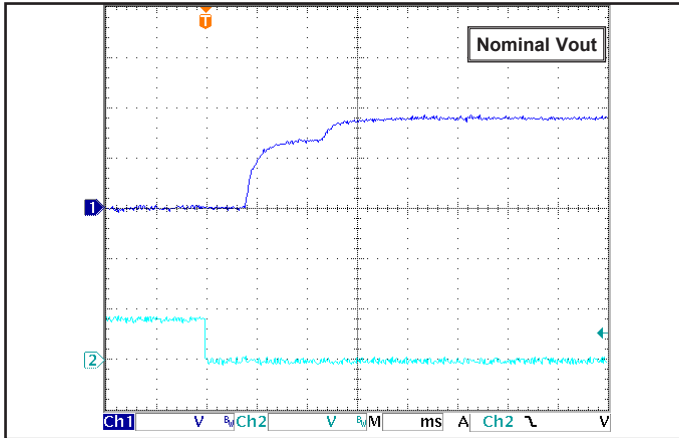

Common Figure 1: Typical startup waveform. Input voltage pre-applied, ON/OFF Pin on Ch 2.

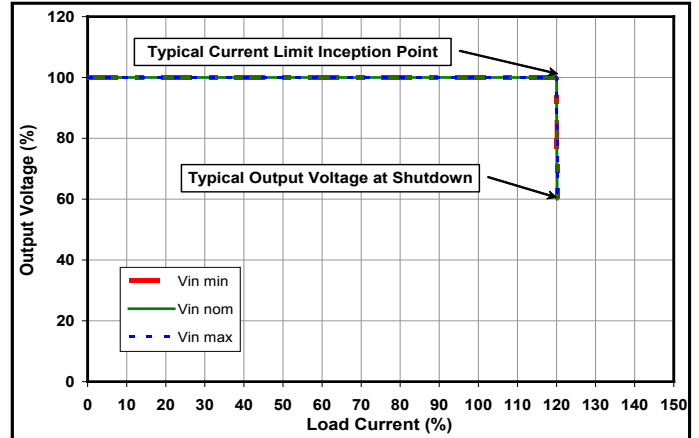

Common Figure 2: Output voltage vs. load current showing typical current limit curves and converter shutdown points.

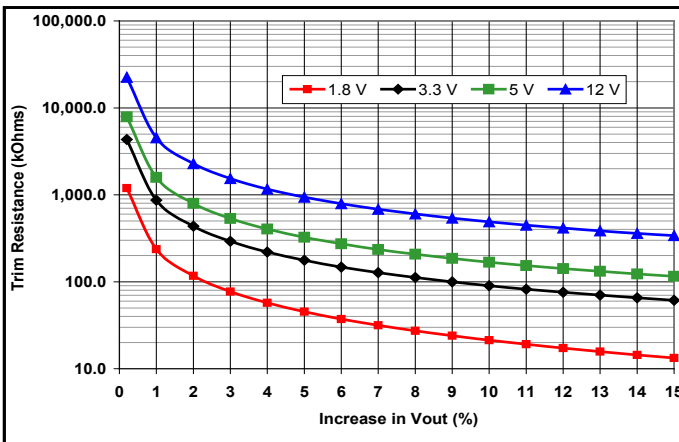

Common Figure 3: Trim graph for trim-up 1.8 to 12V outputs.

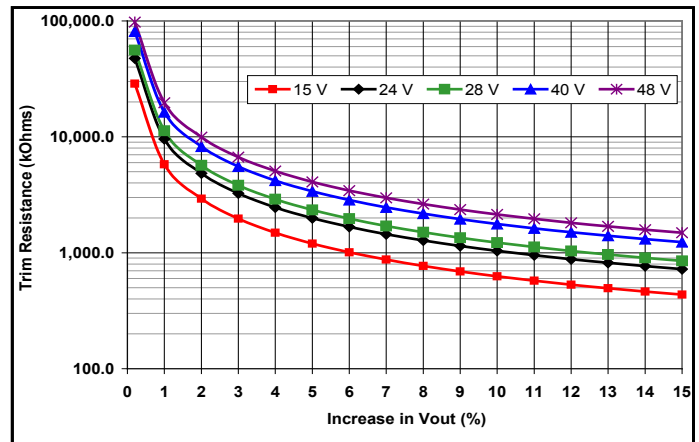

Common Figure 4: Trim graph for trim-up 15 to 48V outputs.

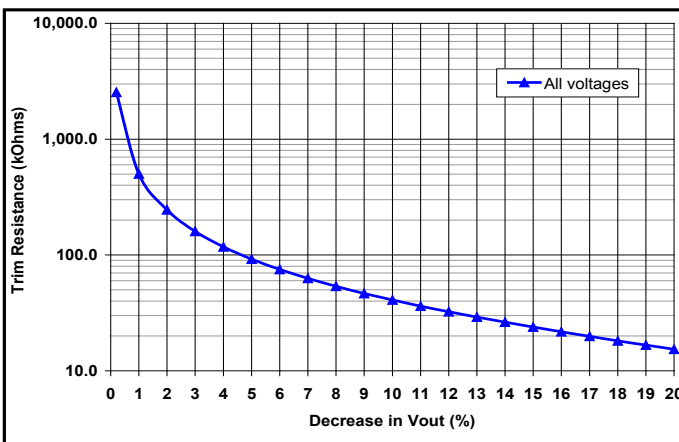

Common Figure 5: Trim graph for trim down.

IQ32018HTx45 Electrical Characteristics (1.8 Vout)

Ta = 25 °C, airflow rate = 300 LFM, Vin = 32V dc unless otherwise noted; full operating temperature range is -40 °C to +100 °C baseplate temperature with appropriate power derating. Specifications subject to change without notice.

Parameter	Min.	Typ.	Max.	Units	Notes & Conditions
INPUT CHARACTERISTICS					
Maximum Input Current			14.7	A	Vin min; trim up; in current limit
No-Load Input Current		300	380	mA	
Disabled Input Current		3	6	mA	
Response to Input Transient		0.06		V	1000 V/ms, 32 V to 100 V step; see Figure 6
Input Terminal Ripple Current		240		mA	RMS
Recommended Input Fuse			25.0	A	Fast acting external fuse recommended
OUTPUT CHARACTERISTICS					
Output Voltage Set Point	1.782	1.800	1.818	V	
Output Voltage Regulation					
Over Line		±0.1	±0.3	%	
Over Load		±0.1	±0.3	%	
Over Temperature	-27		27	mV	
Total Output Voltage Range	1.755		1.845	V	Over sample, line, load, temperature & life
Output Voltage Ripple and Noise					20 MHz bandwidth; see Note 1
Peak-to-Peak	0	90	180	mV	Full load
RMS		19	40	mV	Full load
Operating Output Current Range	0		45	A	Subject to thermal derating
Output DC Current-Limit Inception	49.5	54.0	58.5	A	Output voltage 10% Low
Output DC Current-Limit Shutdown Voltage		0.8		V	
Back-Drive Current Limit while Enabled		0.4		A	Negative current drawn from output
Back-Drive Current Limit while Disabled		1		mA	Negative current drawn from output
Maximum Output Capacitance			15,000	µF	Vout nominal at full load (resistive load)
Output Voltage during Load Current Transient					
Step Change in Output Current (0.1 A/µs)		110		mV	50% to 75% to 50% Iout max
Settling Time		400		µs	To within 1% Vout nom
Output Voltage Trim Range	-20		10	%	Across Pins 8&4; Common Figures 3-5; see Note 2
Output Voltage Remote Sense Range			10	%	Across Pins 8&4
Output Over-Voltage Protection	2.1	2.2	2.3	V	Over full temp range
EFFICIENCY					
100% Load		81		%	See Figure 1 for efficiency curve
50% Load		85		%	See Figure 1 for efficiency curve

Note 1: Output is terminated with 1 µF ceramic and 15 µF low-ESR tantalum capacitors. For applications requiring reduced output voltage ripple and noise, consult SynQor applications support (e-mail: support@synqor.com)

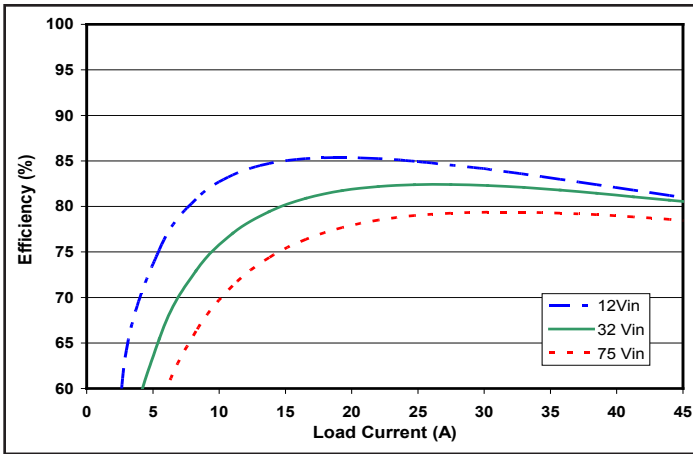

Figure 1: Efficiency at nominal output voltage vs. load current for minimum, nominal, and maximum input voltage at 25°C.

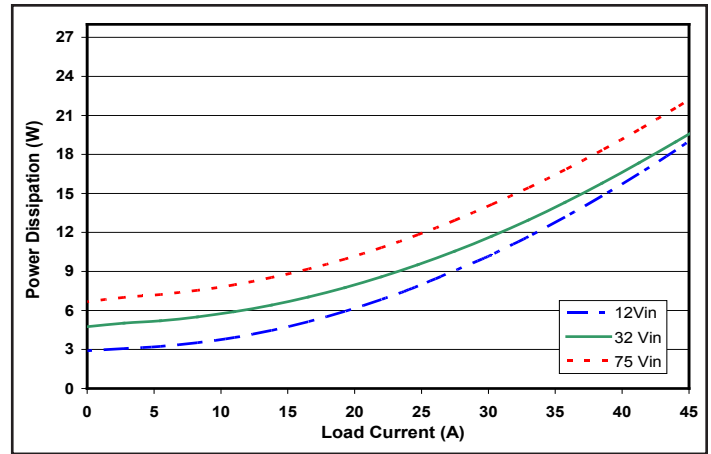

Figure 2: Power dissipation at nominal output voltage vs. load current for minimum, nominal, and maximum input voltage at 25°C.

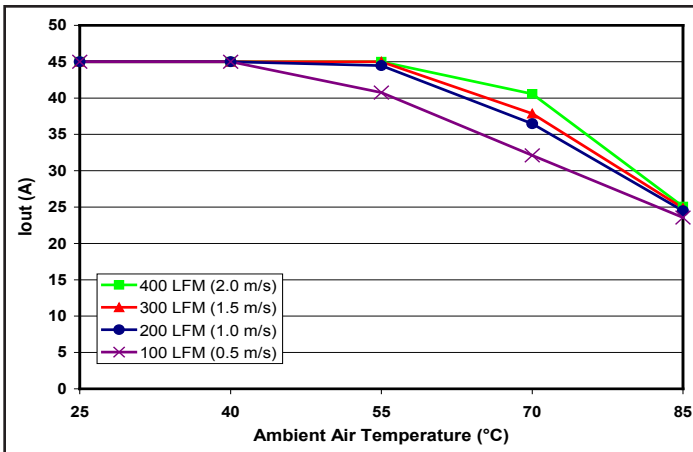

Figure 3: Encased converter (without heatsink) max. output power derating vs. ambient air temperature for airflow rates of 100 LFM through 400 LFM. Air flows across the converter from pin 3 to pin 1 (nominal input voltage).

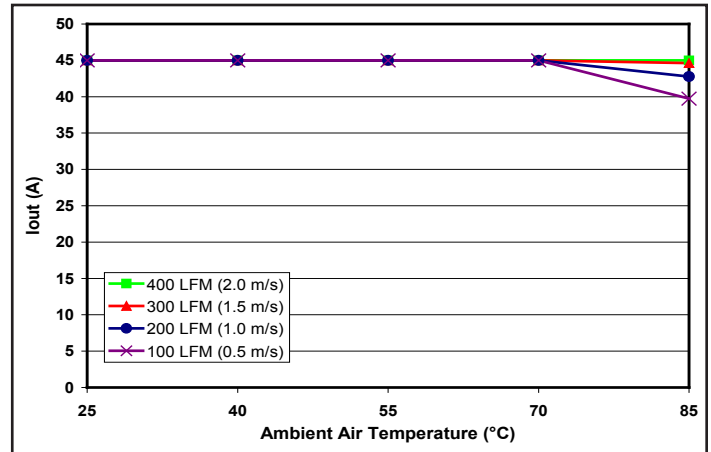

Figure 4: Encased converter (with 1/4" heatsink) max. output power derating vs. ambient air temperature for airflow rates of 100 LFM through 400 LFM. Air flows across the converter from pin 3 to pin 1 (nominal input voltage).

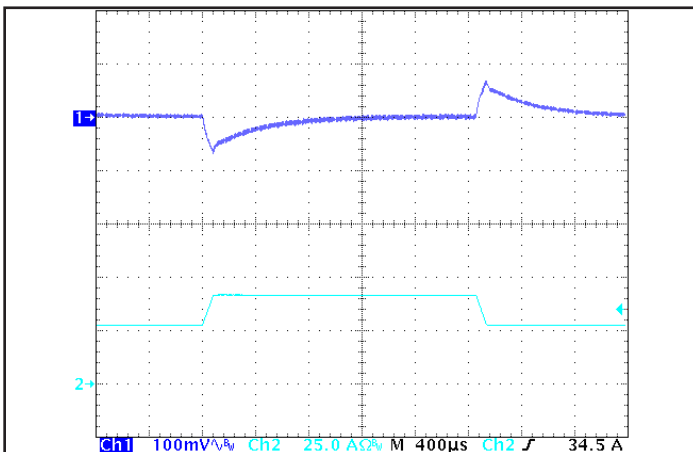

Figure 5: Output voltage response to step-change in load current (66%-100%-66% of Iout(max); dI/dt = 0.1A/μs). Load cap: 15μF tantalum cap and 1μF ceramic cap. Ch 1: Vout, Ch 2: Iout.

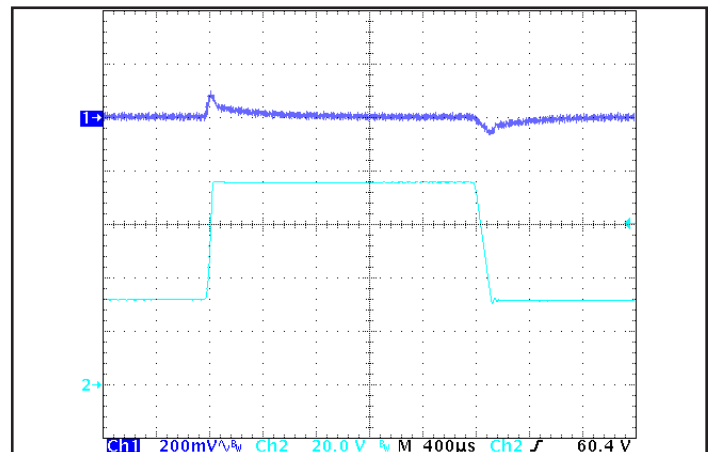

Figure 6: Output voltage response to step-change in input voltage (Vnom.-Vmax-Vnom.), at Max. load current. Load cap: 15μF tantalum capacitor and 1μF ceramic cap. Ch 1: Vout, Ch 2: Vin.

IQ32033HTx33 Electrical Characteristics (3.3 Vout)

Ta = 25 °C, airflow rate = 300 LFM, Vin = 32V dc unless otherwise noted; full operating temperature range is -40 °C to +100 °C baseplate temperature with appropriate power derating. Specifications subject to change without notice.

Parameter	Min.	Typ.	Max.	Units	Notes & Conditions
INPUT CHARACTERISTICS					
Maximum Input Current			19.0	A	Vin min; trim up; in current limit
No-Load Input Current		340	430	mA	
Disabled Input Current		3	6	mA	
Response to Input Transient		0.12		V	1000 V/ms, 32 V to 100 V step; see Figure 6
Input Terminal Ripple Current		440		mA	RMS
Recommended Input Fuse			25.0	A	Fast acting external fuse recommended
OUTPUT CHARACTERISTICS					
Output Voltage Set Point	3.267	3.300	3.333	V	
Output Voltage Regulation					
Over Line		±0.1	±0.3	%	
Over Load		±0.1	±0.3	%	
Over Temperature	-50		50	mV	
Total Output Voltage Range	3.217		3.383	V	Over sample, line, load, temperature & life
Output Voltage Ripple and Noise					20 MHz bandwidth; see Note 1
Peak-to-Peak	0	175	350	mV	Full load
RMS		27	50	mV	Full load
Operating Output Current Range	0		33	A	Subject to thermal derating
Output DC Current-Limit Inception	36.3	39.6	42.9	A	Output voltage 10% Low
Output DC Current-Limit Shutdown Voltage		1.8		V	
Back-Drive Current Limit while Enabled		1.45		A	Negative current drawn from output
Back-Drive Current Limit while Disabled		1		mA	Negative current drawn from output
Maximum Output Capacitance			10,000	µF	Vout nominal at full load (resistive load)
Output Voltage during Load Current Transient					
Step Change in Output Current (0.1 A/µs)		100		mV	50% to 75% to 50% Iout max
Settling Time		200		µs	To within 1% Vout nom
Output Voltage Trim Range	-20		10	%	Across Pins 8&4; Common Figures 3-5
Output Voltage Remote Sense Range			10	%	Across Pins 8&4
Output Over-Voltage Protection	3.9	4.0	4.2	V	Over full temp range
EFFICIENCY					
100% Load		84		%	See Figure 1 for efficiency curve
50% Load		88		%	See Figure 1 for efficiency curve

Note 1: Output is terminated with 1 µF ceramic and 15 µF low-ESR tantalum capacitors. For applications requiring reduced output voltage ripple and noise, consult SynQor applications support (e-mail: support@synqor.com)

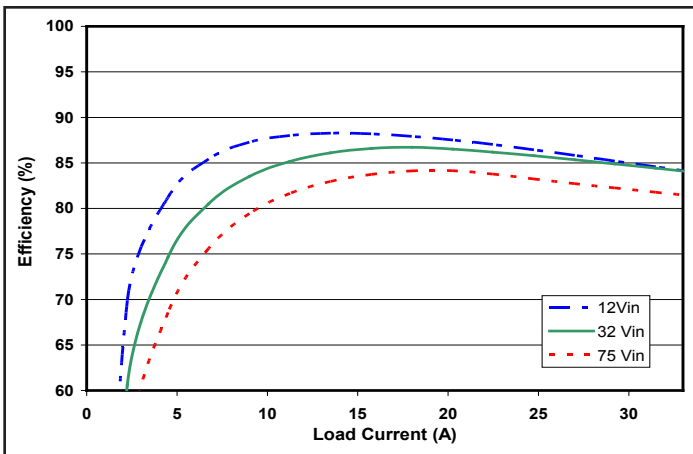

Figure 1: Efficiency at nominal output voltage vs. load current for minimum, nominal, and maximum input voltage at 25°C.

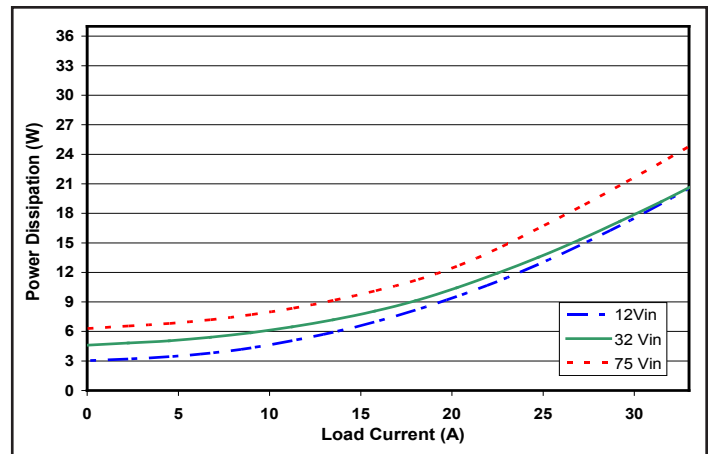

Figure 2: Power dissipation at nominal output voltage vs. load current for minimum, nominal, and maximum input voltage at 25°C.

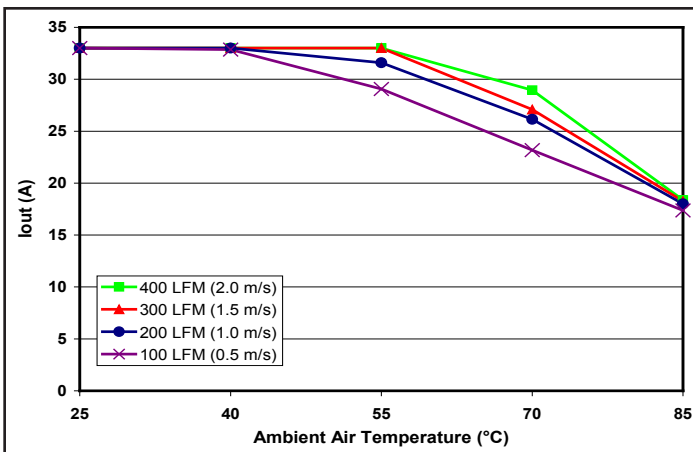

Figure 3: Encased converter (without heatsink) max. output power derating vs. ambient air temperature for airflow rates of 100 LFM through 400 LFM. Air flows across the converter from pin 3 to pin 1 (nominal input voltage).

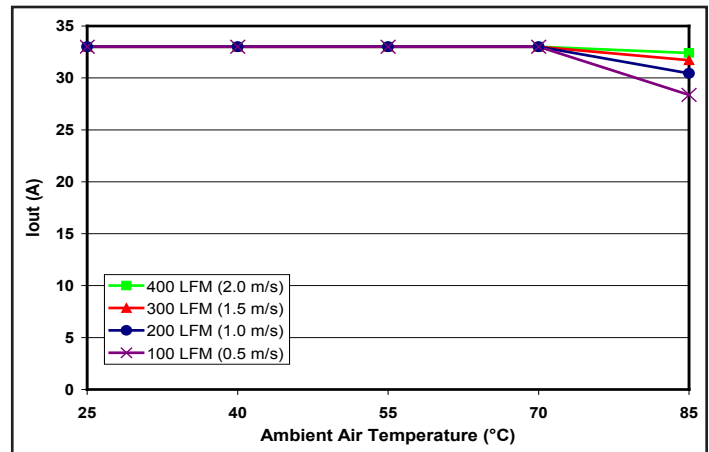

Figure 4: Encased converter (with 1/4" heatsink) max. output power derating vs. ambient air temperature for airflow rates of 100 LFM through 400 LFM. Air flows across the converter from pin 3 to pin 1 (nominal input voltage).

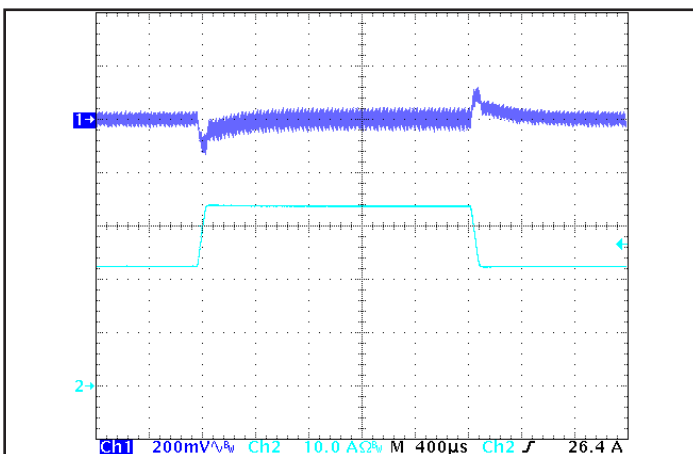

Figure 5: Output voltage response to step-change in load current (66%-100%-66% of Iout(max); dI/dt = 0.1A/μs). Load cap: 15μF tantalum cap and 1μF ceramic cap. Ch 1: Vout, Ch 2: Iout.

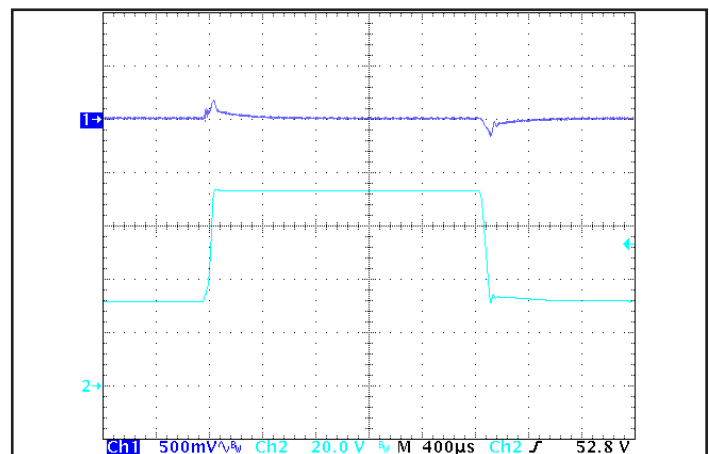

Figure 6: Output voltage response to step-change in input voltage (Vnom.-Vmax.-Vnom.), at Max. load current. Load cap: 15μF tantalum capacitor and 1μF ceramic cap. Ch 1: Vout, Ch 2: Vin.

IQ32050HTx24 Electrical Characteristics (5.0 Vout)

Ta = 25 °C, airflow rate = 300 LFM, Vin = 32V dc unless otherwise noted; full operating temperature range is -40 °C to +100 °C baseplate temperature with appropriate power derating. Specifications subject to change without notice.

Parameter	Min.	Typ.	Max.	Units	Notes & Conditions
INPUT CHARACTERISTICS					
Maximum Input Current			20.7	A	Vin min; trim up; in current limit
No-Load Input Current		325	410	mA	
Disabled Input Current		3	6	mA	
Response to Input Transient		0.15		V	1000 V/ms, 32 V to 100 V step; see Figure 6
Input Terminal Ripple Current		350		mA	RMS
Recommended Input Fuse			25.0	A	Fast acting external fuse recommended
OUTPUT CHARACTERISTICS					
Output Voltage Set Point	4.950	5.000	5.050	V	
Output Voltage Regulation					
Over Line		±0.1	±0.3	%	
Over Load		±0.1	±0.3	%	
Over Temperature	-75		75	mV	
Total Output Voltage Range	4.875		5.125	V	Over sample, line, load, temperature & life
Output Voltage Ripple and Noise					20 MHz bandwidth; see Note 1
Peak-to-Peak	0	140	280	mV	Full load
RMS		18	40	mV	Full load
Operating Output Current Range	0		24	A	Subject to thermal derating
Output DC Current-Limit Inception	26.4	28.8	31.2	A	Output voltage 10% Low
Output DC Current-Limit Shutdown Voltage		2.4		V	
Back-Drive Current Limit while Enabled		0.75		A	Negative current drawn from output
Back-Drive Current Limit while Disabled		1		mA	Negative current drawn from output
Maximum Output Capacitance			8,000	µF	Vout nominal at full load (resistive load)
Output Voltage during Load Current Transient					
Step Change in Output Current (0.1 A/µs)		165		mV	50% to 75% to 50% Iout max
Settling Time		200		µs	To within 1% Vout nom
Output Voltage Trim Range	-20		10	%	Across Pins 8&4; Common Figures 3-5; see Note 2
Output Voltage Remote Sense Range			10	%	Across Pins 8&4
Output Over-Voltage Protection	5.9	6.1	6.4	V	Over full temp range
EFFICIENCY					
100% Load		85		%	See Figure 1 for efficiency curve
50% Load		88		%	See Figure 1 for efficiency curve

Note 1: Output is terminated with 1 µF ceramic and 15 µF low-ESR tantalum capacitors. For applications requiring reduced output voltage ripple and noise, consult SynQor applications support (e-mail: support@synqor.com)

Note 2: Trim-up range is limited below 10% at low line and full load.

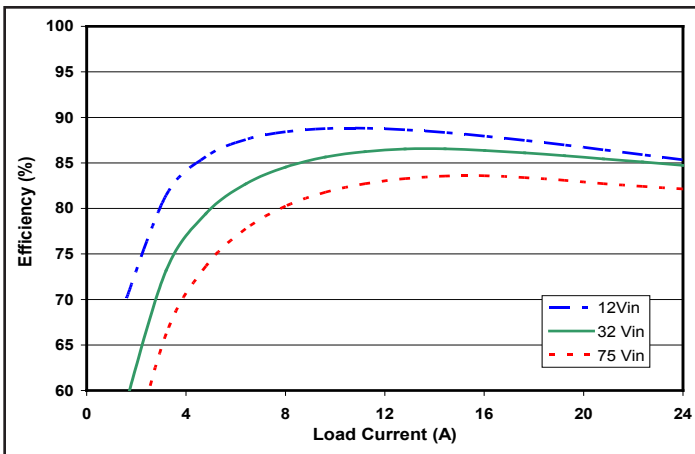

Figure 1: Efficiency at nominal output voltage vs. load current for minimum, nominal, and maximum input voltage at 25°C.

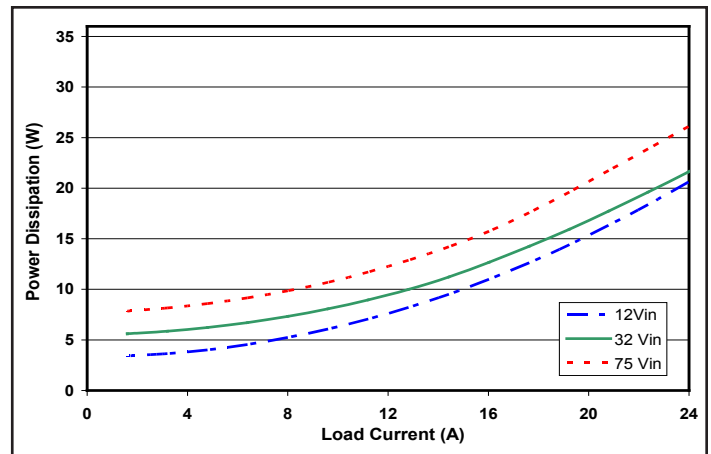

Figure 2: Power dissipation at nominal output voltage vs. load current for minimum, nominal, and maximum input voltage at 25°C.

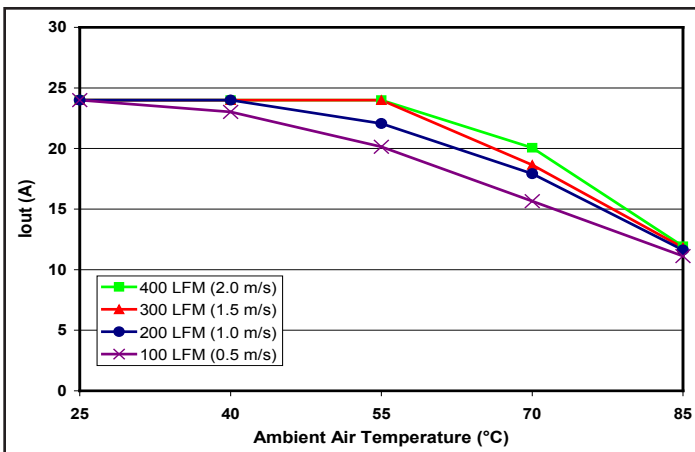

Figure 3: Encased converter (without heatsink) max. output power derating vs. ambient air temperature for airflow rates of 100 LFM through 400 LFM. Air flows across the converter from pin 3 to pin 1 (nominal input voltage).

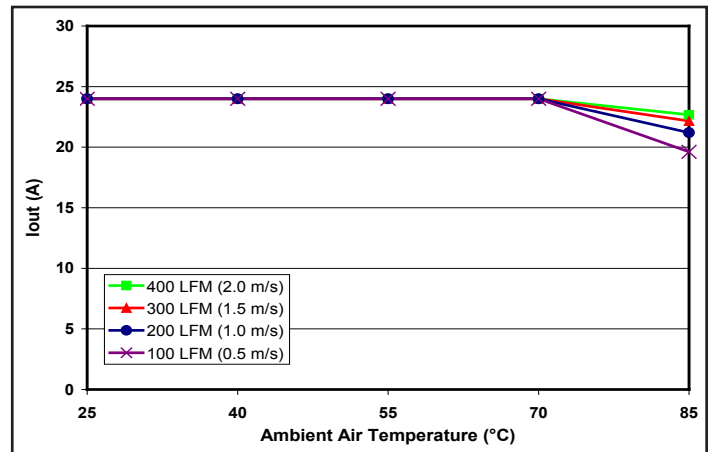

Figure 4: Encased converter (with 1/4" heatsink) max. output power derating vs. ambient air temperature for airflow rates of 100 LFM through 400 LFM. Air flows across the converter from pin 3 to pin 1 (nominal input voltage).

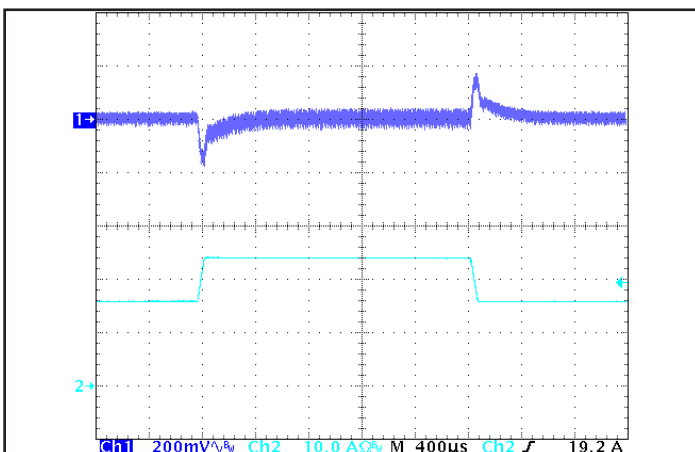

Figure 5: Output voltage response to step-change in load current (66%-100%-66% of Iout(max); dI/dt = 0.1A/us). Load cap: 15µF tantalum cap and 1µF ceramic cap. Ch 1: Vout, Ch 2: Iout.

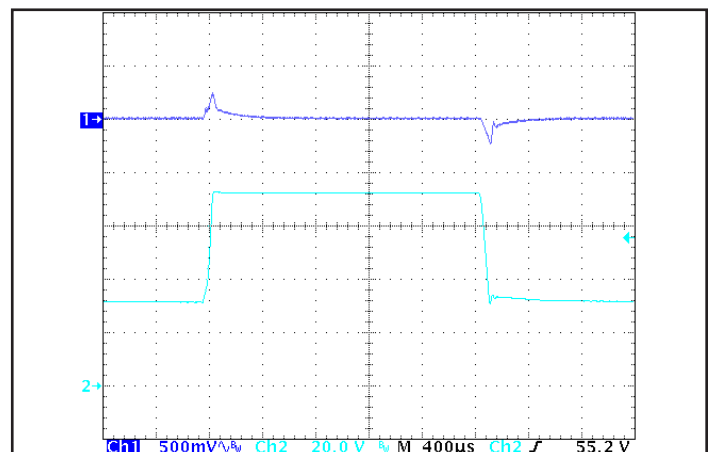

Figure 6: Output voltage response to step-change in input voltage (Vnom.-Vmax-Vnom.), at Max. load current. Load cap: 15µF tantalum capacitor and 1µF ceramic cap. Ch 1: Vout, Ch 2: Vin.

IQ32120HTx10 Electrical Characteristics (12.0 Vout)

Ta = 25 °C, airflow rate = 300 LFM, Vin = 32V dc unless otherwise noted; full operating temperature range is -40 °C to +100 °C baseplate temperature with appropriate power derating. Specifications subject to change without notice.

Parameter	Min.	Typ.	Max.	Units	Notes & Conditions
INPUT CHARACTERISTICS					
Maximum Input Current			20.2	A	Vin min; trim up; in current limit
No-Load Input Current		450	560	mA	
Disabled Input Current		3	6	mA	
Response to Input Transient		0.32		V	1000 V/ms, 32 V to 100 V step; see Figure 6
Input Terminal Ripple Current		330		mA	RMS
Recommended Input Fuse			25.0	A	Fast acting external fuse recommended
OUTPUT CHARACTERISTICS					
Output Voltage Set Point	11.88	12.00	12.12	V	
Output Voltage Regulation					
Over Line		±0.1	±0.3	%	
Over Load		±0.1	±0.3	%	
Over Temperature	-180		180	mV	
Total Output Voltage Range	11.70		12.30	V	Over sample, line, load, temperature & life
Output Voltage Ripple and Noise					20 MHz bandwidth; see Note 1
Peak-to-Peak	0	110	220	mV	Full load
RMS		17	30	mV	Full load
Operating Output Current Range	0		10	A	Subject to thermal derating
Output DC Current-Limit Inception	11.0	12.0	13.0	A	Output voltage 10% Low
Output DC Current-Limit Shutdown Voltage		6		V	
Back-Drive Current Limit while Enabled		0.45		A	Negative current drawn from output
Back-Drive Current Limit while Disabled		1		mA	Negative current drawn from output
Maximum Output Capacitance			1,500	µF	Vout nominal at full load (resistive load)
Output Voltage during Load Current Transient					
Step Change in Output Current (0.1 A/µs)		350		mV	50% to 75% to 50% Iout max
Settling Time		80		µs	To within 1% Vout nom
Output Voltage Trim Range	-20		10	%	Across Pins 8&4; Common Figures 3-5; see Note 2
Output Voltage Remote Sense Range			10	%	Across Pins 8&4
Output Over-Voltage Protection	14.0	14.6	15.2	V	Over full temp range
EFFICIENCY					
100% Load		87		%	See Figure 1 for efficiency curve
50% Load		88		%	See Figure 1 for efficiency curve

Note 1: Output is terminated with 1 µF ceramic and 15 µF low-ESR tantalum capacitors. For applications requiring reduced output voltage ripple and noise, consult SynQor applications support (e-mail: support@synqor.com)

Note 2: Trim-up range is limited below 10% at low line and full load.

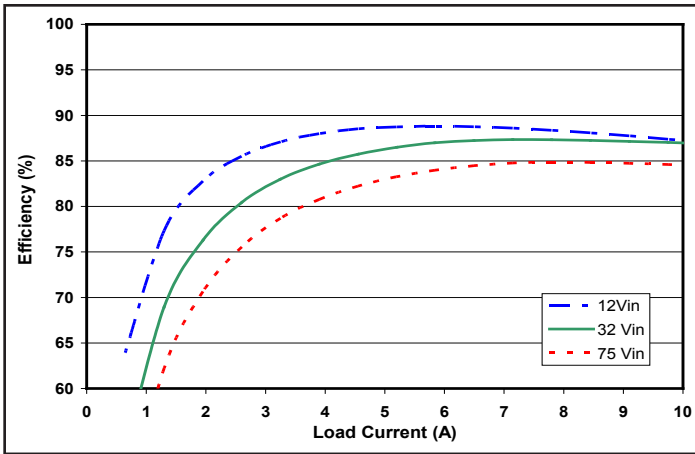

Figure 1: Efficiency at nominal output voltage vs. load current for minimum, nominal, and maximum input voltage at 25°C.

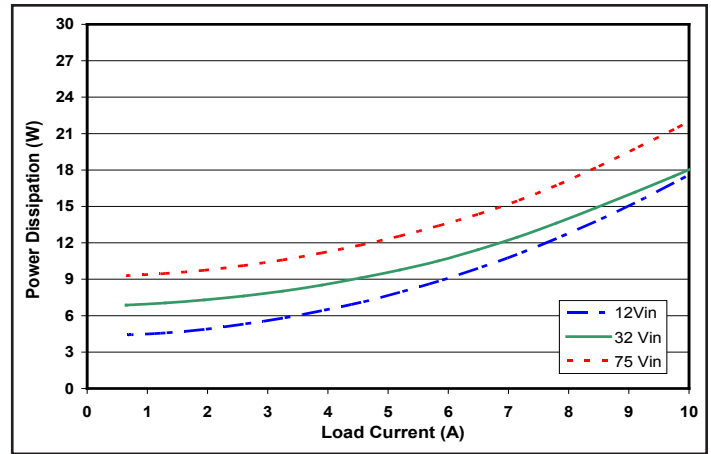

Figure 2: Power dissipation at nominal output voltage vs. load current for minimum, nominal, and maximum input voltage at 25°C.

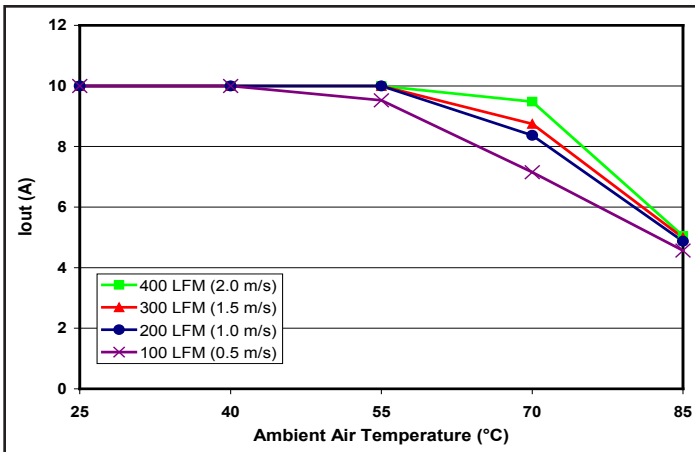

Figure 3: Encased converter (without heatsink) max. output power derating vs. ambient air temperature for airflow rates of 100 LFM through 400 LFM. Air flows across the converter from pin 3 to pin 1 (nominal input voltage).

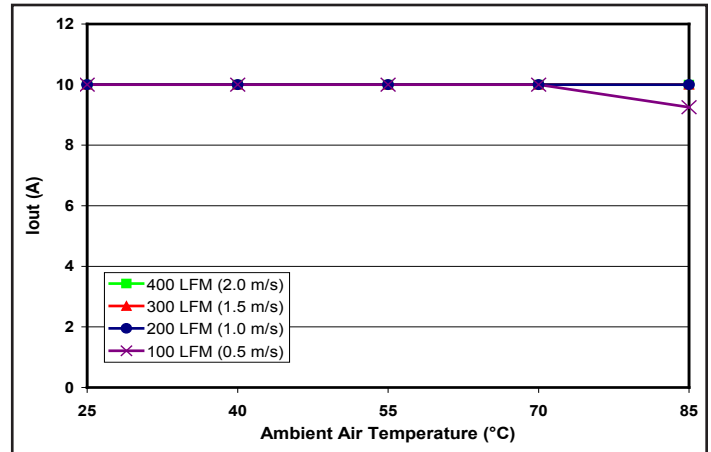

Figure 4: Encased converter (with 1/4" heatsink) max. output power derating vs. ambient air temperature for airflow rates of 100 LFM through 400 LFM. Air flows across the converter from pin 3 to pin 1 (nominal input voltage).

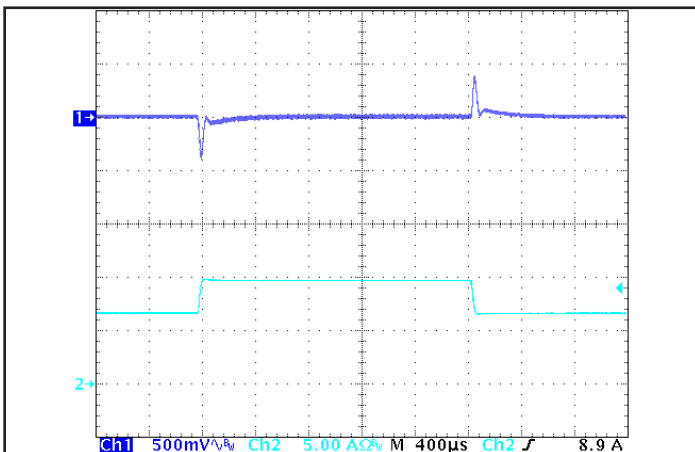

Figure 5: Output voltage response to step-change in load current (66%-100%-66% of Iout(max); dI/dt = 0.1A/μs). Load cap: 15μF tantalum cap and 1μF ceramic cap. Ch 1: Vout, Ch 2: Iout.

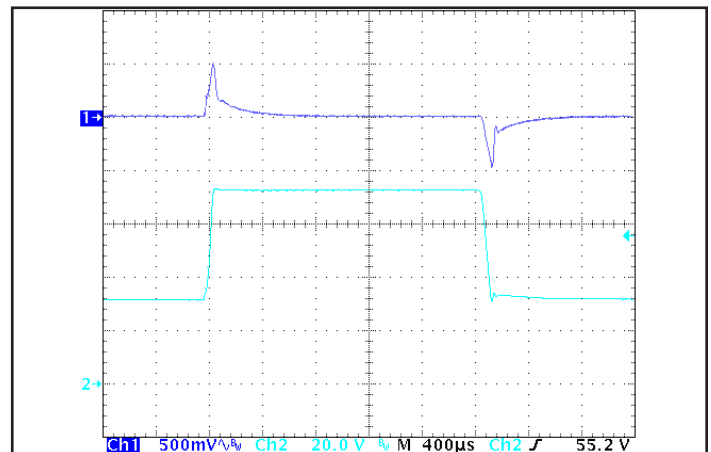

Figure 6: Output voltage response to step-change in input voltage (Vnom.-Vmax-Vnom.), at Max. load current. Load cap: 15μF tantalum capacitor and 1μF ceramic cap. Ch 1: Vout, Ch 2: Vin.

IQ32150HTx08 Electrical Characteristics (15.0 Vout)

Ta = 25 °C, airflow rate = 300 LFM, Vin = 32V dc unless otherwise noted; full operating temperature range is -40 °C to +100 °C baseplate temperature with appropriate power derating. Specifications subject to change without notice.

Parameter	Min.	Typ.	Max.	Units	Notes & Conditions
INPUT CHARACTERISTICS					
Maximum Input Current			20.5	A	Vin min; trim up; in current limit
No-Load Input Current		400	500	mA	
Disabled Input Current		3	6	mA	
Response to Input Transient		0.43		V	1000 V/ms, 32 V to 100 V step; see Figure 6
Input Terminal Ripple Current		375		mA	RMS
Recommended Input Fuse			25.0	A	Fast acting external fuse recommended
OUTPUT CHARACTERISTICS					
Output Voltage Set Point	14.85	15.00	15.15	V	
Output Voltage Regulation					
Over Line		±0.1	±0.3	%	
Over Load		±0.1	±0.3	%	
Over Temperature	-225		225	mV	
Total Output Voltage Range	14.62		15.38	V	Over sample, line, load, temperature & life
Output Voltage Ripple and Noise					20 MHz bandwidth; see Note 1
Peak-to-Peak	0	75	150	mV	Full load
RMS		11	20	mV	Full load
Operating Output Current Range	0		8	A	Subject to thermal derating
Output DC Current-Limit Inception	8.8	9.6	10.4	A	Output voltage 10% Low
Output DC Current-Limit Shutdown Voltage		8		V	
Back-Drive Current Limit while Enabled		0.5		A	Negative current drawn from output
Back-Drive Current Limit while Disabled		1		mA	Negative current drawn from output
Maximum Output Capacitance			1,000	µF	Vout nominal at full load (resistive load)
Output Voltage during Load Current Transient					
Step Change in Output Current (0.1 A/µs)		660		mV	50% to 75% to 50% Iout max
Settling Time		80		µs	To within 1% Vout nom
Output Voltage Trim Range	-20		10	%	Across Pins 8&4; Common Figures 3-5
Output Voltage Remote Sense Range			10	%	Across Pins 8&4
Output Over-Voltage Protection	17.6	18.3	19.1	V	Over full temp range
EFFICIENCY					
100% Load		86		%	See Figure 1 for efficiency curve
50% Load		88		%	See Figure 1 for efficiency curve

Note 1: Output is terminated with 1 µF ceramic and 15 µF low-ESR tantalum capacitors. For applications requiring reduced output voltage ripple and noise, consult SynQor applications support (e-mail: support@synqor.com)

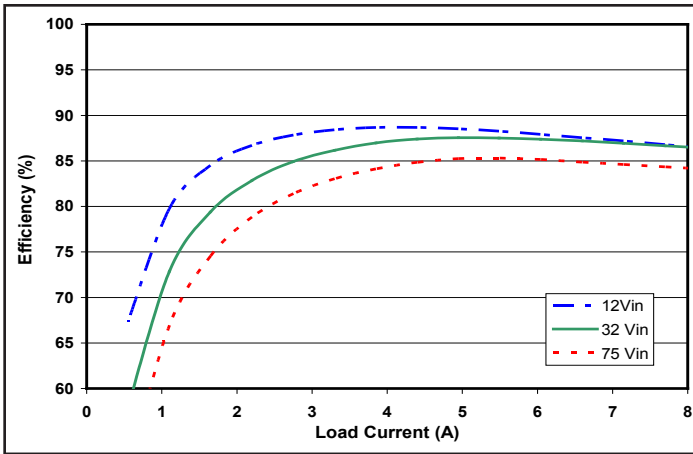

Figure 1: Efficiency at nominal output voltage vs. load current for minimum, nominal, and maximum input voltage at 25°C.

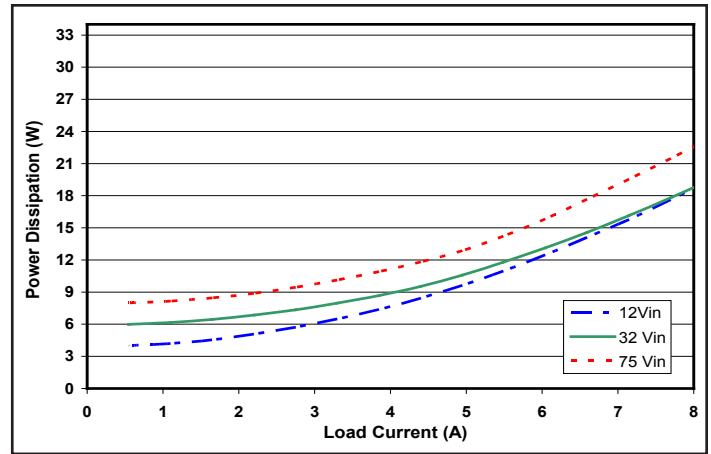

Figure 2: Power dissipation at nominal output voltage vs. load current for minimum, nominal, and maximum input voltage at 25°C.

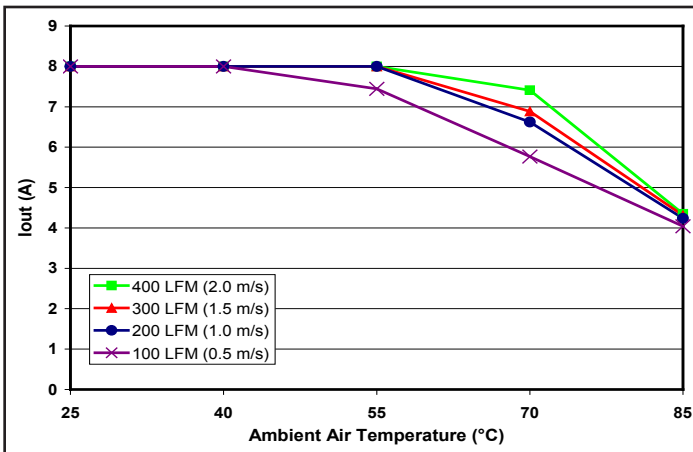

Figure 3: Encased converter (without heatsink) max. output power derating vs. ambient air temperature for airflow rates of 100 LFM through 400 LFM. Air flows across the converter from pin 3 to pin 1 (nominal input voltage).

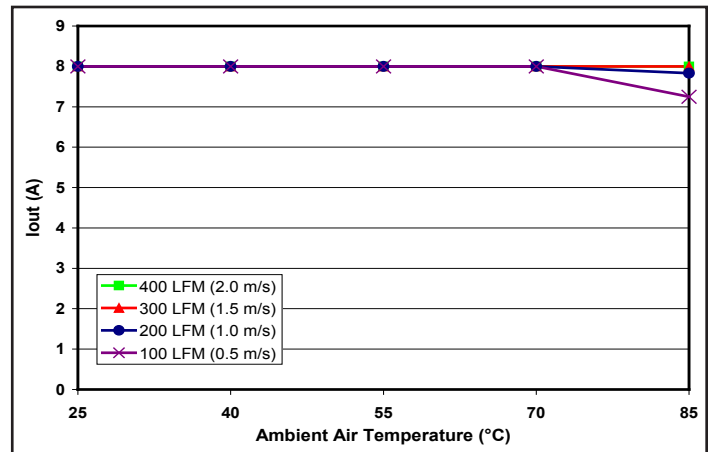

Figure 4: Encased converter (with 1/4" heatsink) max. output power derating vs. ambient air temperature for airflow rates of 100 LFM through 400 LFM. Air flows across the converter from pin 3 to pin 1 (nominal input voltage).

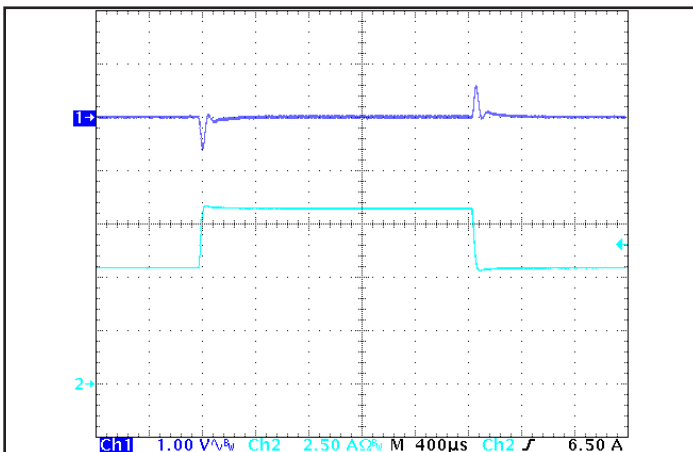

Figure 5: Output voltage response to step-change in load current (66%-100%-66% of I_{out}(max); dI/dt = 0.1A/μs). Load cap: 15μF tantalum cap and 1μF ceramic cap. Ch 1: V_{out}, Ch 2: I_{out}.

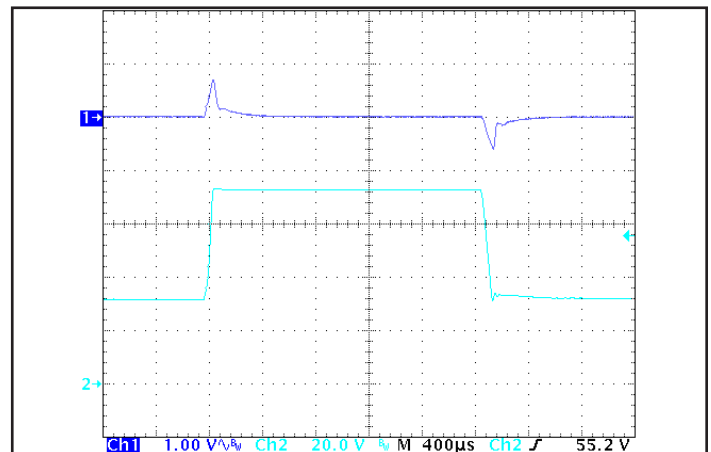

Figure 6: Output voltage response to step-change in input voltage (V_{nom}-V_{max}-V_{nom}), at Max. load current. Load cap: 15μF tantalum capacitor and 1μF ceramic cap. Ch 1: V_{out}, Ch 2: V_{in}.

IQ32240HTx05 Electrical Characteristics (24.0 Vout)

Ta = 25 °C, airflow rate = 300 LFM, Vin = 32V dc unless otherwise noted; full operating temperature range is -40 °C to +100 °C baseplate temperature with appropriate power derating. Specifications subject to change without notice.

Parameter	Min.	Typ.	Max.	Units	Notes & Conditions
INPUT CHARACTERISTICS					
Maximum Input Current			20.7	A	Vin min; trim up; in current limit
No-Load Input Current		330	410	mA	
Disabled Input Current		3	6	mA	
Response to Input Transient		1.2		V	1000 V/ms, 32 V to 100 V step; see Figure 6
Input Terminal Ripple Current		360		mA	RMS
Recommended Input Fuse			25.0	A	Fast acting external fuse recommended
OUTPUT CHARACTERISTICS					
Output Voltage Set Point	3.76	24.00	24.24	V	
Output Voltage Regulation					
Over Line		±0.1	±0.3	%	
Over Load		±0.1	±0.3	%	
Over Temperature	-360		360	mV	
Total Output Voltage Range	23.40		24.60	V	Over sample, line, load, temperature & life
Output Voltage Ripple and Noise					20 MHz bandwidth; see Note 1
Peak-to-Peak	0	150	300	mV	Full load
RMS		21	40	mV	Full load
Operating Output Current Range	0		5	A	Subject to thermal derating
Output DC Current-Limit Inception	5.5	6.0	6.5	A	Output voltage 10% Low
Output DC Current-Limit Shutdown Voltage		13		V	
Back-Drive Current Limit while Enabled		0.25		A	Negative current drawn from output
Back-Drive Current Limit while Disabled		1		mA	Negative current drawn from output
Maximum Output Capacitance			400	µF	Vout nominal at full load (resistive load)
Output Voltage during Load Current Transient					
Step Change in Output Current (0.1 A/µs)		1400		mV	50% to 75% to 50% Iout max
Settling Time		80		µs	To within 1% Vout nom
Output Voltage Trim Range	-20		10	%	Across Pins 8&4; Common Figures 3-5
Output Voltage Remote Sense Range			10	%	Across Pins 8&4
Output Over-Voltage Protection	28.1	29.3	30.5	V	Over full temp range
EFFICIENCY					
100% Load		85		%	See Figure 1 for efficiency curve
50% Load		88		%	See Figure 1 for efficiency curve

Note 1: Output is terminated with 1 µF ceramic capacitor. For applications requiring reduced output voltage ripple and noise, consult SynQor applications support (e-mail: support@synqor.com)

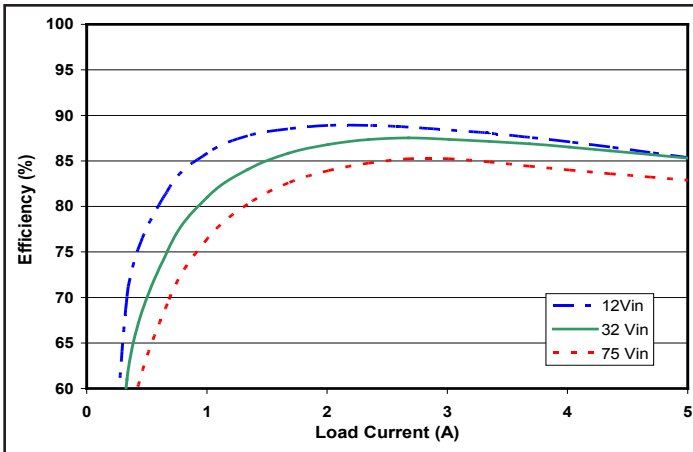

Figure 1: Efficiency at nominal output voltage vs. load current for minimum, nominal, and maximum input voltage at 25°C.

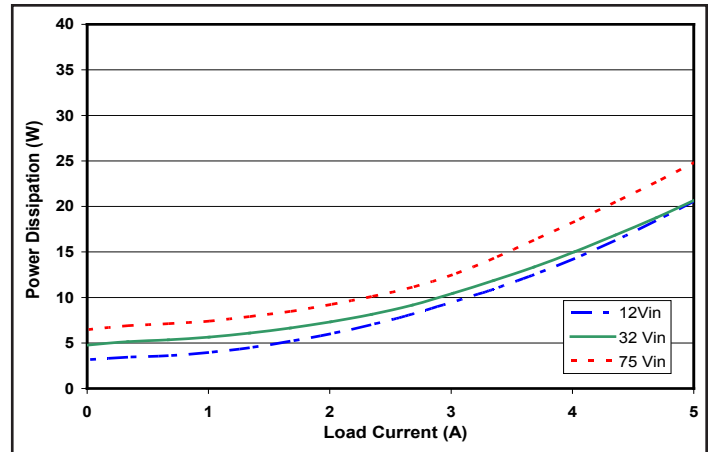

Figure 2: Power dissipation at nominal output voltage vs. load current for minimum, nominal, and maximum input voltage at 25°C.

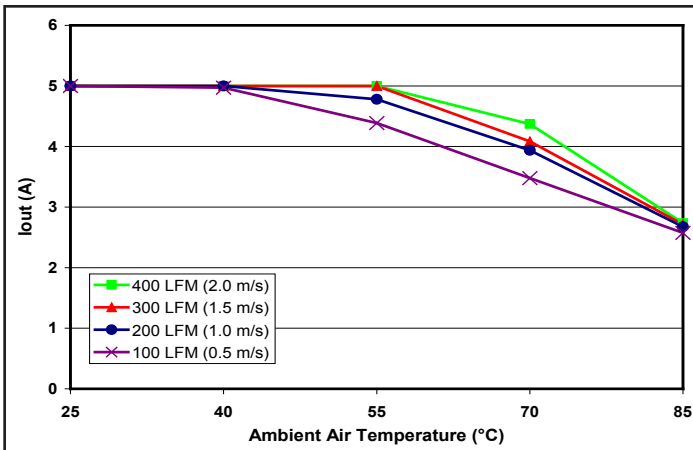

Figure 3: Encased converter (without heatsink) max. output power derating vs. ambient air temperature for airflow rates of 100 LFM through 400 LFM. Air flows across the converter from pin 3 to pin 1 (nominal input voltage).

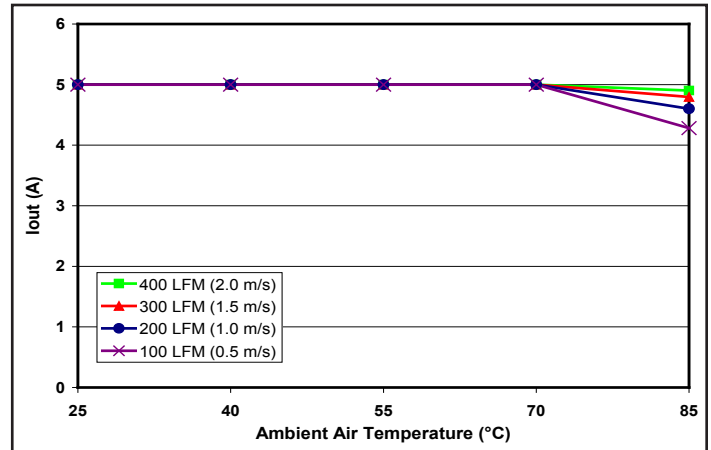

Figure 4: Encased converter (with 1/4" heatsink) max. output power derating vs. ambient air temperature for airflow rates of 100 LFM through 400 LFM. Air flows across the converter from pin 3 to pin 1 (nominal input voltage).

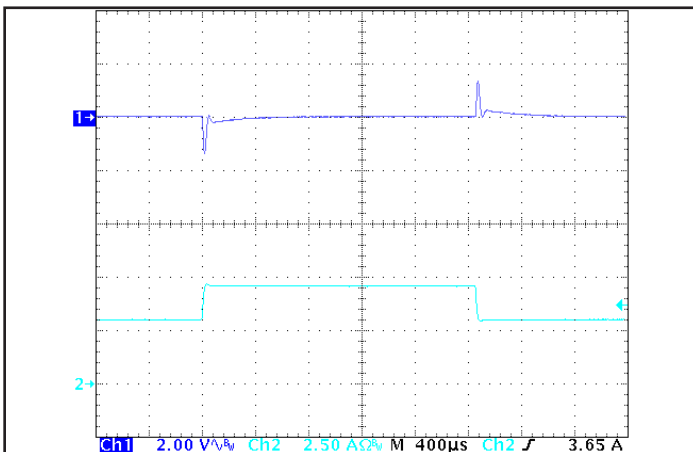

Figure 5: Output voltage response to step-change in load current (66%-100%-66% of I_{out}(max); dI/dt = 0.1A/μs). Load cap: 1μF ceramic cap. Ch 1: V_{out}, Ch 2: I_{out}.

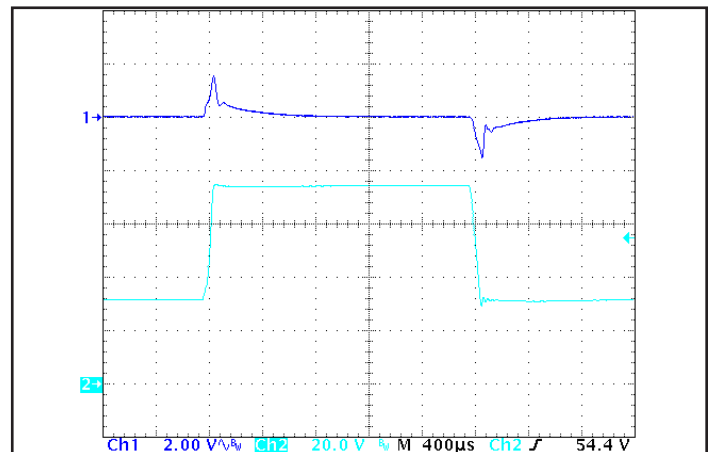

Figure 6: Output voltage response to step-change in input voltage (V_{nom.}-V_{max.}-V_{nom.}), at Max. load current. Load cap: 1μF ceramic cap. Ch 1: V_{out}, Ch 2: V_{in}.

IQ32280HTx05 Electrical Characteristics (28.0 Vout)

Ta = 25 °C, airflow rate = 300 LFM, Vin = 32V dc unless otherwise noted; full operating temperature range is -40 °C to +100 °C baseplate temperature with appropriate power derating. Specifications subject to change without notice.

Parameter	Min.	Typ.	Max.	Units	Notes & Conditions
INPUT CHARACTERISTICS					
Maximum Input Current			21.7	A	Vin min; trim up; in current limit
No-Load Input Current		350	440	mA	
Disabled Input Current		3	6	mA	
Response to Input Transient		1.5		V	1000 V/ms, 32 V to 100 V step; see Figure 6
Input Terminal Ripple Current		390		mA	RMS
Recommended Input Fuse			25.0	A	Fast acting external fuse recommended
OUTPUT CHARACTERISTICS					
Output Voltage Set Point	7.72	28.00	28.28	V	
Output Voltage Regulation					
Over Line		±0.1	±0.3	%	
Over Load		±0.1	±0.3	%	
Over Temperature	-420		420	mV	
Total Output Voltage Range	27.30		28.70	V	Over sample, line, load, temperature & life
Output Voltage Ripple and Noise					20 MHz bandwidth; see Note 1
Peak-to-Peak	0	160	320	mV	Full load
RMS		21	40	mV	Full load
Operating Output Current Range	0		4.5	A	Subject to thermal derating
Output DC Current-Limit Inception	5.0	5.4	5.9	A	Output voltage 10% Low
Output DC Current-Limit Shutdown Voltage		15		V	
Back-Drive Current Limit while Enabled		0.25		A	Negative current drawn from output
Back-Drive Current Limit while Disabled		1		mA	Negative current drawn from output
Maximum Output Capacitance			250	µF	Vout nominal at full load (resistive load)
Output Voltage during Load Current Transient					
Step Change in Output Current (0.1 A/µs)		1600		mV	50% to 75% to 50% Iout max
Settling Time		80		µs	To within 1% Vout nom
Output Voltage Trim Range	-20		10	%	Across Pins 8&4; Common Figures 3-5
Output Voltage Remote Sense Range			10	%	Across Pins 8&4
Output Over-Voltage Protection	32.8	34.2	35.6	V	Over full temp range
EFFICIENCY					
100% Load		85		%	See Figure 1 for efficiency curve
50% Load		88		%	See Figure 1 for efficiency curve

Note 1: Output is terminated with 1 µF ceramic capacitor. For applications requiring reduced output voltage ripple and noise, consult SynQor applications support (e-mail: support@synqor.com)

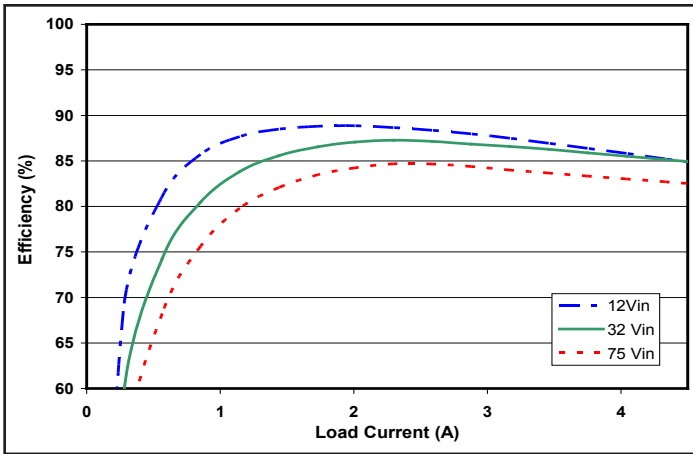

Figure 1: Efficiency at nominal output voltage vs. load current for minimum, nominal, and maximum input voltage at 25°C.

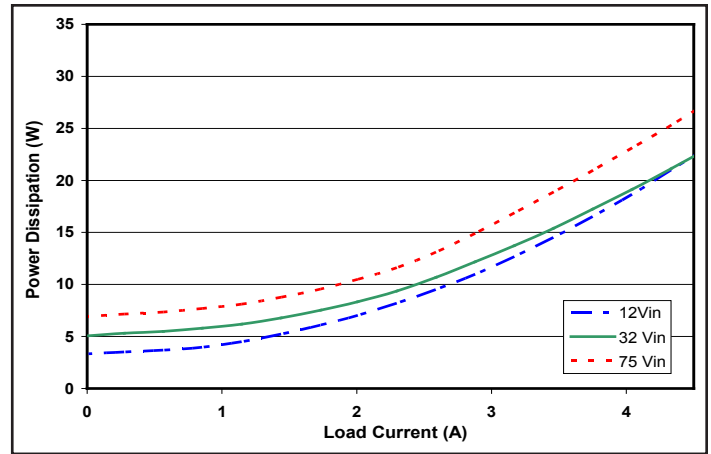

Figure 2: Power dissipation at nominal output voltage vs. load current for minimum, nominal, and maximum input voltage at 25°C.

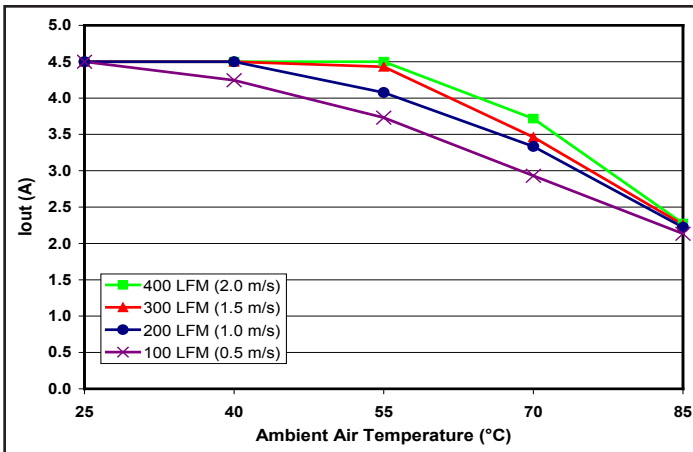

Figure 3: Encased converter (without heatsink) max. output power derating vs. ambient air temperature for airflow rates of 100 LFM through 400 LFM. Air flows across the converter from pin 3 to pin 1 (nominal input voltage).

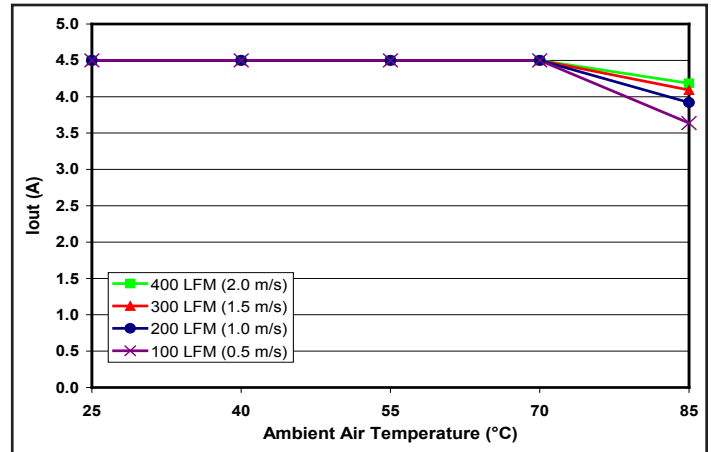

Figure 4: Encased converter (with 1/4" heatsink) max. output power derating vs. ambient air temperature for airflow rates of 100 LFM through 400 LFM. Air flows across the converter from pin 3 to pin 1 (nominal input voltage).

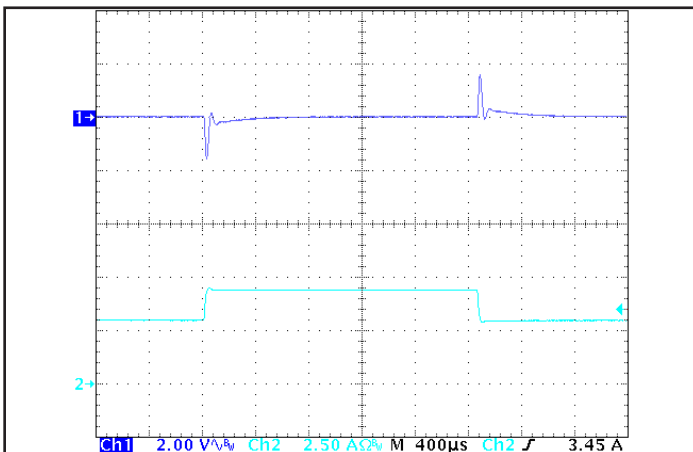

Figure 5: Output voltage response to step-change in load current (66%-100%-66% of I_{out}(max); dI/dt = 0.1A/μs). Load cap: 1μF ceramic cap. Ch 1: V_{out}, Ch 2: I_{out}.

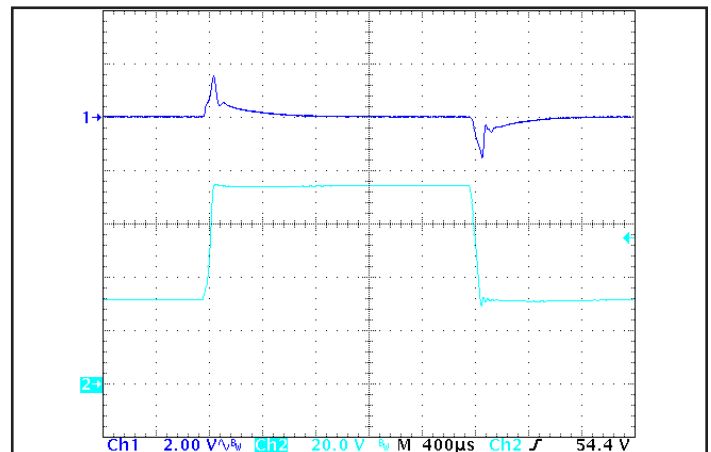

Figure 6: Output voltage response to step-change in input voltage (V_{nom.}-V_{max.}-V_{nom.}), at Max. load current. Load cap: 1μF ceramic cap. Ch 1: V_{out}, Ch 2: V_{in}.

IQ32400HTx03 Electrical Characteristics (40.0 Vout)

Ta = 25 °C, airflow rate = 300 LFM, Vin = 32V dc unless otherwise noted; full operating temperature range is -40 °C to +100 °C baseplate temperature with appropriate power derating. Specifications subject to change without notice.

Parameter	Min.	Typ.	Max.	Units	Notes & Conditions
INPUT CHARACTERISTICS					
Maximum Input Current			20.7	A	Vin min; trim up; in current limit
No-Load Input Current		400	500	mA	
Disabled Input Current		3	6	mA	
Response to Input Transient		2.4		V	1000 V/ms, 32 V to 100 V step; see Figure 6
Input Terminal Ripple Current		350		mA	RMS
Recommended Input Fuse			25.0	A	Fast acting external fuse recommended
OUTPUT CHARACTERISTICS					
Output Voltage Set Point	9.60	40.00	40.40	V	
Output Voltage Regulation					
Over Line		±0.1	±0.3	%	
Over Load		±0.1	±0.3	%	
Over Temperature	-600		600	mV	
Total Output Voltage Range	39.00		41.00	V	Over sample, line, load, temperature & life
Output Voltage Ripple and Noise					20 MHz bandwidth; see Note 1
Peak-to-Peak	0	180	360	mV	Full load
RMS		22	40	mV	Full load
Operating Output Current Range	0		3	A	Subject to thermal derating
Output DC Current-Limit Inception	3.3	3.6	3.9	A	Output voltage 10% Low
Output DC Current-Limit Shutdown Voltage		22		V	
Back-Drive Current Limit while Enabled		0.25		A	Negative current drawn from output
Back-Drive Current Limit while Disabled		1		mA	Negative current drawn from output
Maximum Output Capacitance			150	µF	Vout nominal at full load (resistive load)
Output Voltage during Load Current Transient					
Step Change in Output Current (0.1 A/µs)		2500		mV	50% to 75% to 50% Iout max
Settling Time		80		µs	To within 1% Vout nom
Output Voltage Trim Range	-20		10	%	Across Pins 8&4; Common Figures 3-5
Output Voltage Remote Sense Range			10	%	Across Pins 8&4
Output Over-Voltage Protection	46.8	48.8	50.8	V	Over full temp range
EFFICIENCY					
100% Load		85		%	See Figure 1 for efficiency curve
50% Load		88		%	See Figure 1 for efficiency curve

Note 1: Output is terminated with 1 µF ceramic capacitor. For applications requiring reduced output voltage ripple and noise, consult SynQor applications support (e-mail: support@synqor.com)

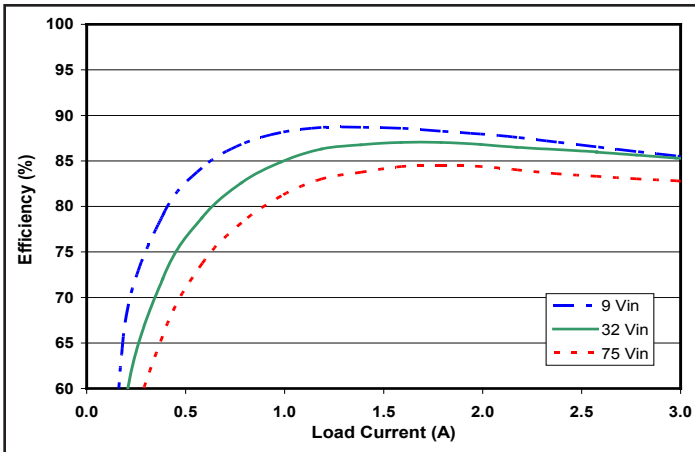

Figure 1: Efficiency at nominal output voltage vs. load current for minimum, nominal, and maximum input voltage at 25°C.

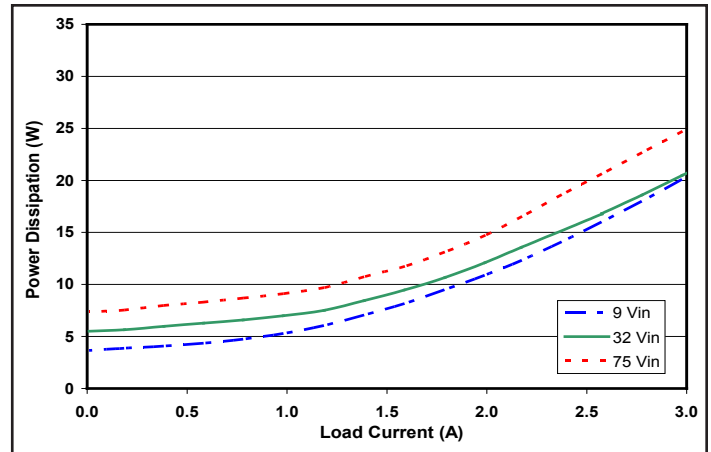

Figure 2: Power dissipation at nominal output voltage vs. load current for minimum, nominal, and maximum input voltage at 25°C.

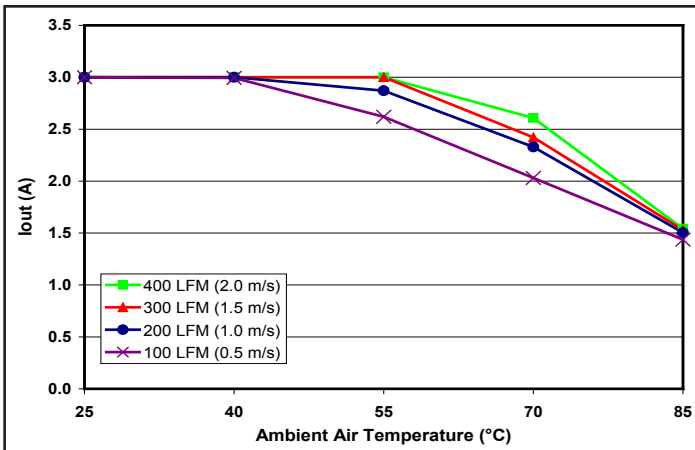

Figure 3: Encased converter (without heatsink) max. output power derating vs. ambient air temperature for airflow rates of 100 LFM through 400 LFM. Air flows across the converter from pin 3 to pin 1 (nominal input voltage).

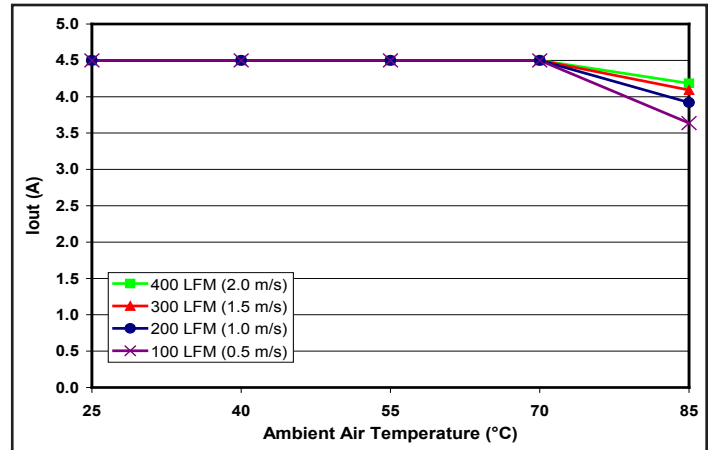

Figure 4: Encased converter (with 1/4" heatsink) max. output power derating vs. ambient air temperature for airflow rates of 100 LFM through 400 LFM. Air flows across the converter from pin 3 to pin 1 (nominal input voltage).

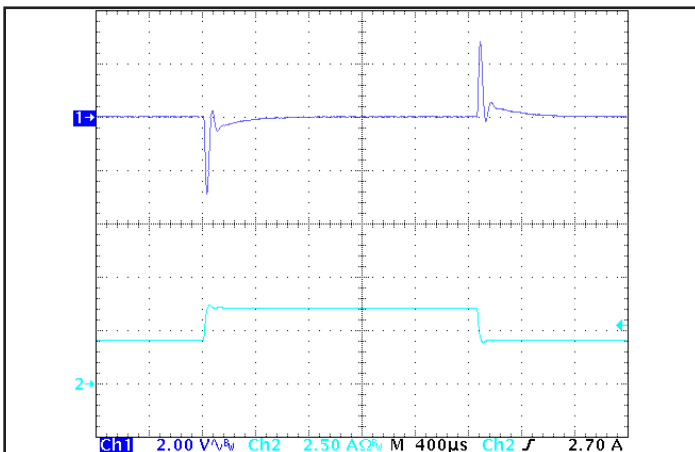

Figure 5: Output voltage response to step-change in load current (66%-100%-66% of I_{out}(max); dI/dt = 0.1A/μs). Load cap: 1μF ceramic cap. Ch 1: V_{out}, Ch 2: I_{out}.

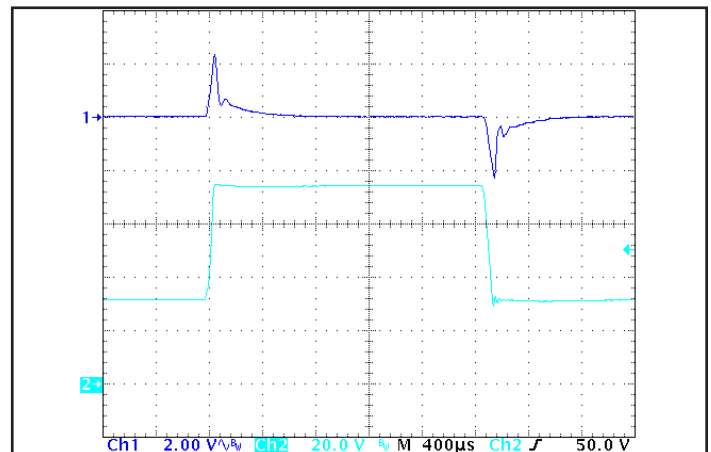

Figure 6: Output voltage response to step-change in input voltage (V_{nom.}-V_{max.}-V_{nom.}), at Max. load current. Load cap: 1μF ceramic cap. Ch 1: V_{out}, Ch 2: V_{in}.

IQ32480HTx03 Electrical Characteristics (48.0 Vout)

Ta = 25 °C, airflow rate = 300 LFM, Vin = 32V dc unless otherwise noted; full operating temperature range is -40 °C to +100 °C baseplate temperature with appropriate power derating. Specifications subject to change without notice.

Parameter	Min.	Typ.	Max.	Units	Notes & Conditions
INPUT CHARACTERISTICS					
Maximum Input Current			20.0	A	Vin min; trim up; in current limit
No-Load Input Current		180	230	mA	
Disabled Input Current		1	2	mA	
Response to Input Transient		3.9		V	1000 V/ms, 32 V to 100 V step; see Figure 6
Input Terminal Ripple Current		900		mA	RMS
Recommended Input Fuse			25.0	A	Fast acting external fuse recommended
OUTPUT CHARACTERISTICS					
Output Voltage Set Point	7.52	48.00	48.48	V	
Output Voltage Regulation					
Over Line		±0.1	±0.3	%	
Over Load		±0.1	±0.3	%	
Over Temperature	-720		720	mV	
Total Output Voltage Range	46.80		49.20	V	Over sample, line, load, temperature & life
Output Voltage Ripple and Noise					20 MHz bandwidth; see Note 1
Peak-to-Peak	0	80	160	mV	Full load
RMS		17	30	mV	Full load
Operating Output Current Range	0		2.5	A	Subject to thermal derating
Output DC Current-Limit Inception	2.8	3.0	3.3	A	Output voltage 10% Low
Output DC Current-Limit Shutdown Voltage		31		V	
Back-Drive Current Limit while Enabled		0.1		A	Negative current drawn from output
Back-Drive Current Limit while Disabled		1		mA	Negative current drawn from output
Maximum Output Capacitance			100	µF	Vout nominal at full load (resistive load)
Output Voltage during Load Current Transient					
Step Change in Output Current (0.1 A/µs)		2200		mV	50% to 75% to 50% Iout max
Settling Time		80		µs	To within 1% Vout nom
Output Voltage Trim Range	-20		10	%	Across Pins 8&4; Common Figures 3-5
Output Voltage Remote Sense Range			10	%	Across Pins 8&4
Output Over-Voltage Protection	56.2	58.6	61.0	V	Over full temp range
EFFICIENCY					
100% Load		88		%	See Figure 1 for efficiency curve
50% Load		90		%	See Figure 1 for efficiency curve

Note 1: Output is terminated with 1 µF ceramic capacitor. For applications requiring reduced output voltage ripple and noise, consult SynQor applications support (e-mail: support@synqor.com)

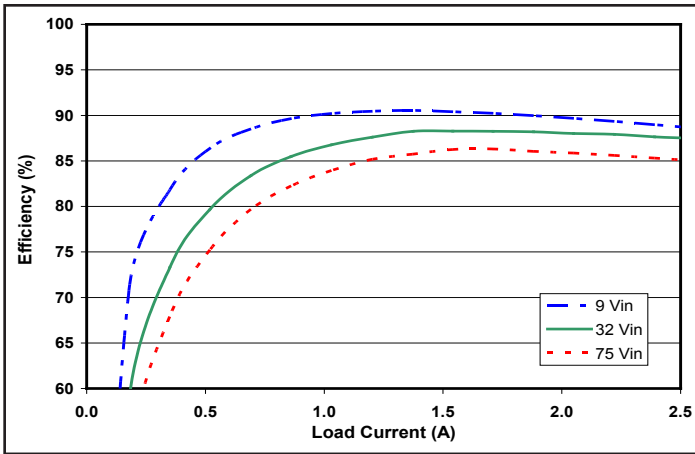

Figure 1: Efficiency at nominal output voltage vs. load current for minimum, nominal, and maximum input voltage at 25°C.

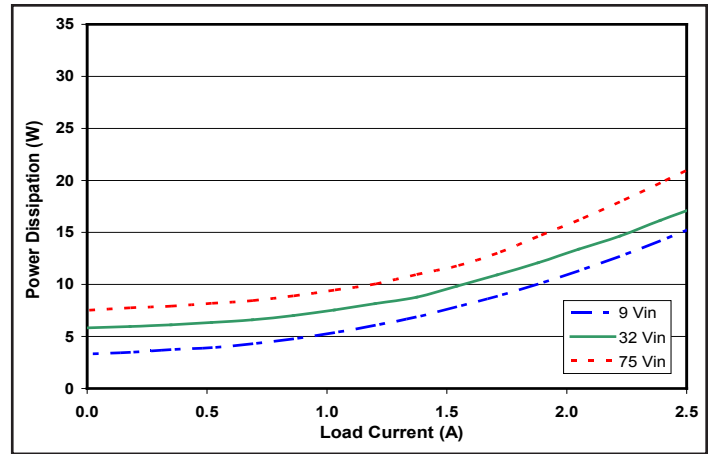

Figure 2: Power dissipation at nominal output voltage vs. load current for minimum, nominal, and maximum input voltage at 25°C.

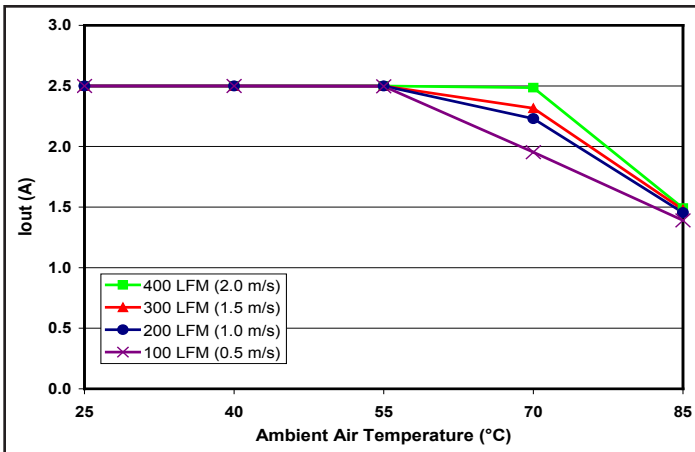

Figure 3: Encased converter (without heatsink) max. output power derating vs. ambient air temperature for airflow rates of 100 LFM through 400 LFM. Air flows across the converter from pin 3 to pin 1 (nominal input voltage).

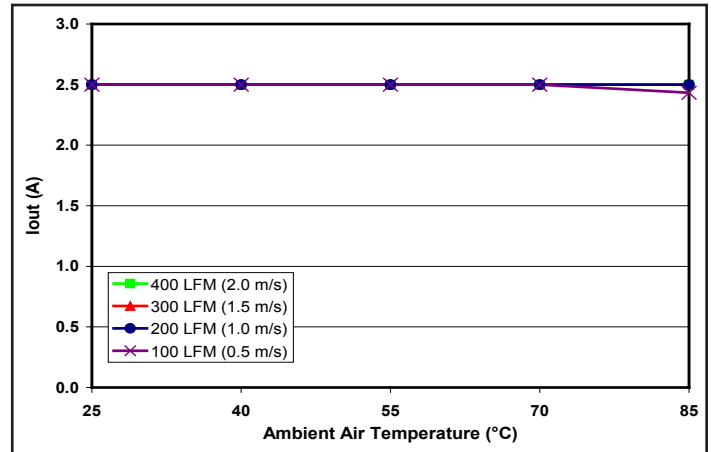

Figure 4: Encased converter (with 1/4" heatsink) max. output power derating vs. ambient air temperature for airflow rates of 100 LFM through 400 LFM. Air flows across the converter from pin 3 to pin 1 (nominal input voltage).

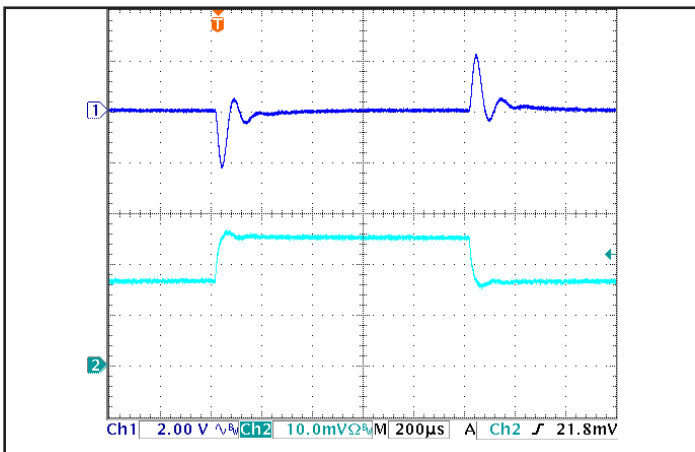

Figure 5: Output voltage response to step-change in load current (66%-100%-66% of Iout(max); dI/dt = 0.1A/µs). Load cap: 1µF ceramic cap. Ch 1: Vout, Ch 2: Iout (1 A/div).

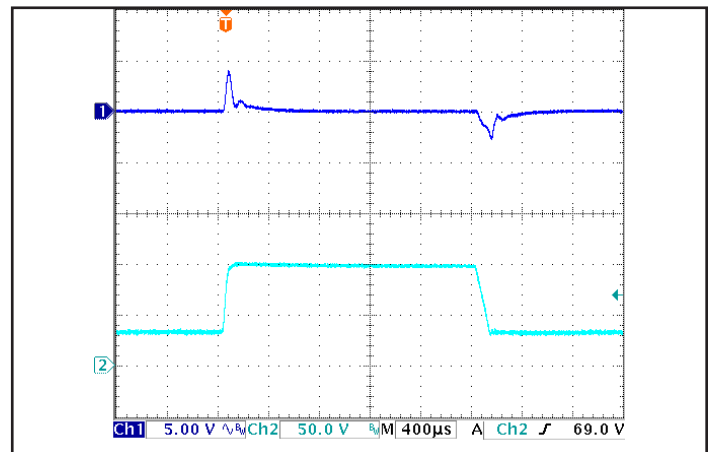

Figure 6: Output voltage response to step-change in input voltage (Vnom.-Vmax.-Vnom.), at Max. load current. Load cap: 1µF ceramic cap. Ch 1: Vout, Ch 2: Vin.

BASIC OPERATION AND FEATURES

This converter series uses a two-stage power conversion topology. The first stage is a buck-converter that keeps the output voltage constant over variations in line, load, and temperature. The second stage uses a transformer to provide the functions of input/output isolation and voltage step-up or step-down to achieve the output voltage required.

Both the first stage and the second stage switch at a fixed frequency for predictable EMI performance. Rectification of the transformer's output is accomplished with synchronous rectifiers. These devices, which are MOSFETs with a very low on-state resistance, dissipate far less energy than Schottky diodes. This is the primary reason that the converter has such high efficiency, even at very low output voltages and very high output currents.

These converters are offered totally encased to withstand harsh environments and thermally demanding applications. Dissipation throughout the converter is so low that it does not require a heatsink for operation in many applications; however, adding a heatsink provides improved thermal derating performance in extreme situations.

This series of converters use the industry standard footprint and pin-out configuration.

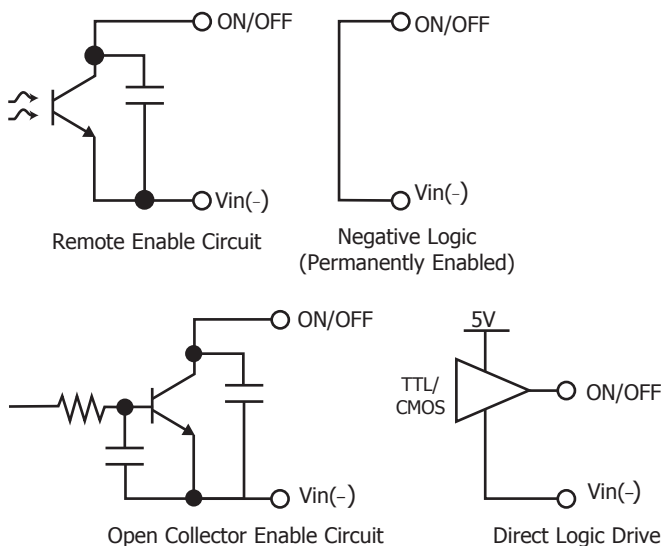

Figure A: Various circuits for driving the ON/OFF pin.

CONTROL FEATURES

REMOTE ON/OFF (Pin 2): The ON/OFF input, Pin 2, permits the user to control when the converter is on or off. This input is referenced to the return terminal of the input bus, Vin(-). The ON/OFF signal is active low (meaning that a low turns the converter on). Figure A details four possible circuits for driving the ON/OFF pin. Figure B is a detailed look of the internal ON/OFF circuitry.

REMOTE SENSE(±) (Pins 7 and 5): The SENSE(±) inputs correct for voltage drops along the conductors that connect the converter's output pins to the load.

Pin 7 should be connected to Vout(+) and Pin 5 should be connected to Vout(-) at the point on the board where regulation is desired. A remote connection at the load can adjust for a voltage drop only as large as that specified in this datasheet, that is

$$[V_{out(+)} - V_{out(-)}] - [V_{sense(+)} - V_{sense(-)}] \leq \text{Sense Range \%} \times V_{out}$$

Pins 7 and 5 must be connected for proper regulation of the output voltage. If these connections are not made, the converter will deliver an output voltage that is slightly higher than its specified value.

Note: the output over-voltage protection circuit senses the voltage across the output (pins 8 and 4) to determine when it should trigger, not the voltage across the converter's sense leads (pins 7 and 5). Therefore, the resistive drop on the board should be small enough so that output OVP does not trigger, even during load transients.

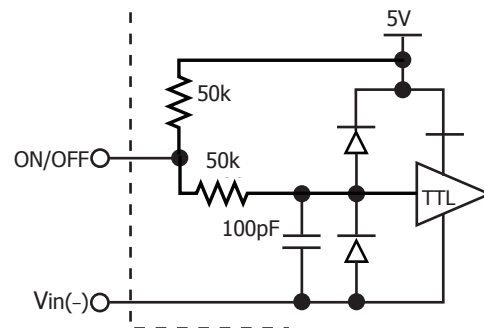

Figure B: Internal ON/OFF pin circuitry

OUTPUT VOLTAGE TRIM (Pin 6): The TRIM input permits the user to adjust the output voltage across the sense leads up or down according to the trim range specifications.

To decrease the output voltage, the user should connect a resistor between Pin 6 and Pin 5 (SENSE(-) input). For a desired decrease of the nominal output voltage, the value of the resistor should be

$$R_{\text{trim-down}} = \left(\frac{511}{\Delta\%} \right) - 10.22 \text{ (k}\Omega\text{)}$$

where

$$\Delta\% = \left| \frac{V_{\text{nominal}} - V_{\text{desired}}}{V_{\text{nominal}}} \right| \times 100\%$$

To increase the output voltage, the user should connect a resistor between Pin 6 and Pin 7 (SENSE(+) input). For a desired increase of the nominal output voltage, the value of the resistor should be

$$R_{\text{trim-up}} = \left(\frac{5.11V_{\text{OUT}} \times (100 + \Delta\%)}{1.225\Delta\%} - \frac{511}{\Delta\%} - 10.22 \right) \text{ (k}\Omega\text{)}$$

where V_{out} = Nominal Output Voltage

Trim graphs show the relationship between the trim resistor value and $R_{\text{trim-up}}$ and $R_{\text{trim-down}}$, showing the total range the output voltage can be trimmed up or down.

Note: the TRIM feature does not affect the voltage at which the output over-voltage protection circuit is triggered. Trimming the output voltage too high may cause the over-voltage protection circuit to engage, particularly during transients.

It is not necessary for the user to add capacitance at the Trim pin. The node is internally bypassed to eliminate noise.

Total DC Variation of VOUT: For the converter to meet its full specifications, the maximum variation of the dc value of VOUT, due to both trimming and remote load voltage drops, should not be greater than that specified for the output voltage trim range.

PROTECTION FEATURES

Input Under-Voltage Lockout: The converter is designed to turn off when the input voltage is too low, helping avoid an input system instability problem, described in more detail in the application note titled "Input System Instability" on our website. The lockout circuitry is a comparator with dc hysteresis. When the input voltage is rising, it must exceed the typical Turn-On Voltage Threshold value (listed on the specifications page) before the converter will turn on. Once the converter is on, the input voltage must fall below the typical Turn-Off Voltage Threshold value before the converter will turn off.

Output Current Limit: The maximum current limit remains constant as the output voltage drops. However, once the impedance of the load across the output is small enough to make the output voltage drop below the specified Output DC Current-Limit Shutdown Voltage, the converter turns off.

The converter then enters a "hiccup mode" where it repeatedly turns on and off at a 5 Hz (nominal) frequency with a 5% duty cycle until the short circuit condition is removed. This prevents excessive heating of the converter or the load board.

Output Over-Voltage Limit: If the voltage across the output pins exceeds the Output Over-Voltage Protection threshold, the converter will immediately stop switching. This prevents damage to the load circuit due to 1) excessive series resistance in output current path from converter output pins to sense point, 2) a release of a short-circuit condition, or 3) a release of a current limit condition. Load capacitance determines exactly how high the output voltage will rise in response to these conditions. After 200 ms the converter will automatically restart.

Over-Temperature Shutdown: A temperature sensor on the converter senses the average temperature of the module. The thermal shutdown circuit is designed to turn the converter off when the temperature at the sensed location reaches the Over-Temperature Shutdown value. It will allow the converter to turn on again when the temperature of the sensed location falls by the amount of the Over-Temperature Shutdown Restart Hysteresis value.

APPLICATION CONSIDERATIONS

Input System Instability: This condition can occur because any dc-dc converter appears incrementally as a negative resistance load. A detailed application note titled "Input System Instability" is available on the SynQor website which provides an understanding of why this instability arises, and shows the preferred solution for correcting it.

Application Circuits: Figure C provides a typical circuit diagram which details the input filtering and voltage trimming.

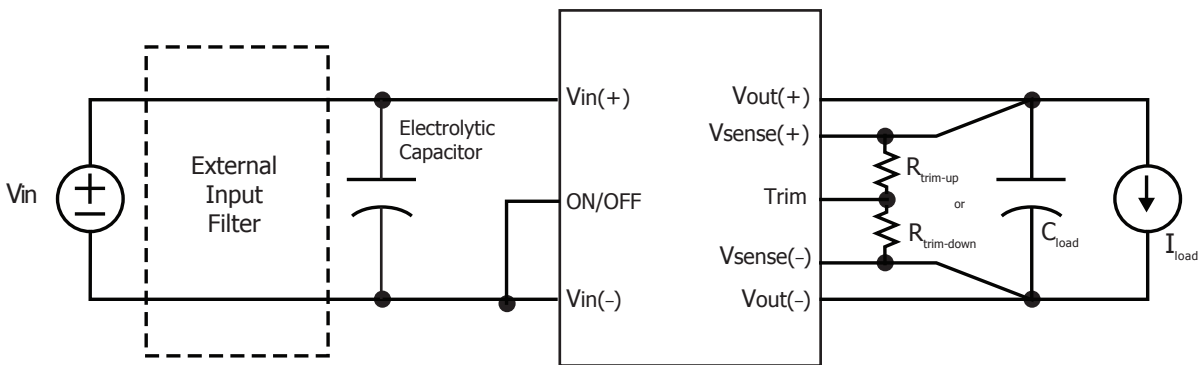

Figure C: Typical application circuit (negative logic unit, permanently enabled).

Input Filtering and External Capacitance: Figure D provides a diagram showing the internal input filter components. This filter dramatically reduces input terminal ripple current, which otherwise could exceed the rating of an external electrolytic input capacitor.

The recommended external input capacitance is specified in the Input Characteristics section on the Electrical Characteristics page. More detailed information is available in the application note titled "EMI Characteristics" on the SynQor website.

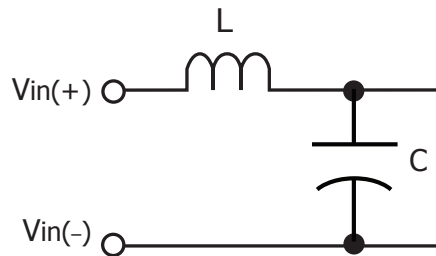

Figure D: Internal Input Filter Diagram (component values listed on the specifications page).

Startup Inhibit Period: The Startup Inhibit Period ensures that the converter will remain off for approximately 200 ms when it is shut down for any reason. When an output short is present, this generates a 5 Hz "hiccup mode," which prevents the converter from overheating. In all, there are seven ways that the converter can be shut down, initiating a Startup Inhibit Period:

- Input Under-Voltage Lockout
- Input Over-Voltage Lockout
- Output Over-Voltage Protection
- Over Temperature Shutdown
- Current Limit
- Short Circuit Protection
- Turned off by the ON/OFF input

Figure E shows three turn-on scenarios, where a Startup Inhibit Period is initiated at t_0 , t_1 , and t_2 :

Before time t_0 , when the input voltage is below the UVL threshold, the unit is disabled by the Input Under-Voltage Lockout feature. When the input voltage rises above the UVL threshold, the Input Under-Voltage Lockout is released, and a Startup Inhibit Period is initiated. At the end of this delay, the ON/OFF pin is evaluated, and since it is active, the unit turns on.

At time t_1 , the unit is disabled by the ON/OFF pin, and it cannot be enabled again until the Startup Inhibit Period has elapsed.

When the ON/OFF pin goes high after t_2 , the Startup Inhibit Period has elapsed, and the output turns on within the typical Turn-On Time.

Thermal Considerations: The maximum operating base-plate temperature, T_B , is 100 °C. As long as the user's thermal system keeps $T_B \leq 100$ °C, the converter can deliver its full rated power.

A power derating curve can be calculated for any heatsink that is attached to the base-plate of the converter. It is only necessary to determine the thermal resistance, R_{THBA} , of the chosen heatsink between the base-plate and the ambient air for a given airflow rate. This information is usually available from the heatsink vendor. The following formula can be used to determine the maximum power the converter can dissipate for a given thermal condition if its base-plate is to be no higher than 100 °C.

$$P_{diss}^{max} = \frac{100 \text{ °C} - T_A}{R_{THBA}}$$

This value of power dissipation can then be used in conjunction with the data shown in Figure 2 to determine the maximum load current (and power) that the converter can deliver in the given thermal condition.

For convenience, power derating curves for an encased converter without a heatsink and with a typical heatsink are provided for each output voltage.

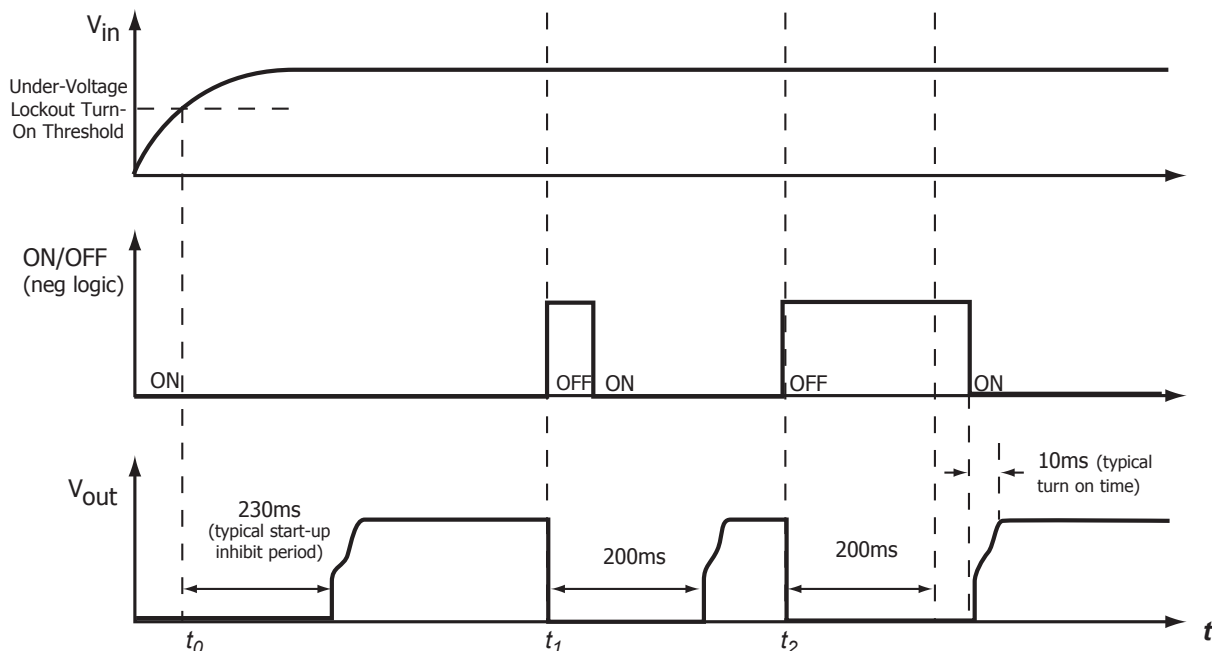

Figure E: Startup Inhibit Period (turn-on time not to scale)

Standards & Qualification Testing

Parameter	Notes & Conditions
STANDARDS COMPLIANCE	
UL 60950-1: 2003	Basic Insulation
CAN/CSA-C22.2 No. 60950-1:2003	
EN60950-1:2001	
IEC 61000-4-2	ESD test, 8 kV - NP, 15 kV air - NP (Normal Performance)

Note: An external input fuse must always be used to meet these safety requirements. Contact SynQor for official safety certificates on new releases or download from the SynQor website.

Parameter	# Units	Test Conditions
QUALIFICATION TESTING		
Life Test	32	95% rated Vin and load, units at derating point, 1000 hours
Vibration	5	10-55 Hz sweep, 0.060" total excursion, 1 min./sweep, 120 sweeps for 3 axis
Mechanical Shock	5	100g minimum, 2 drops in x, y, and z axis
Temperature Cycling	10	-40 °C to 100 °C, unit temp. ramp 15 °C/min., 500 cycles
Power/Thermal Cycling	5	Toperating = min to max, Vin = min to max, full load, 100 cycles
Design Marginality	5	Tmin-10 °C to Tmax+10 °C, 5 °C steps, Vin = min to max, 0-105% load
Humidity	5	85 °C, 85% RH, 1000 hours, continuous Vin applied except 5 min/day
Solderability	15 pins	MIL-STD-883, method 2003
Altitude	2	70,000 feet (21 km), see Note

Note: A conductive cooling design is generally needed for high altitude applications because of naturally poor convective cooling at rare atmospheres.

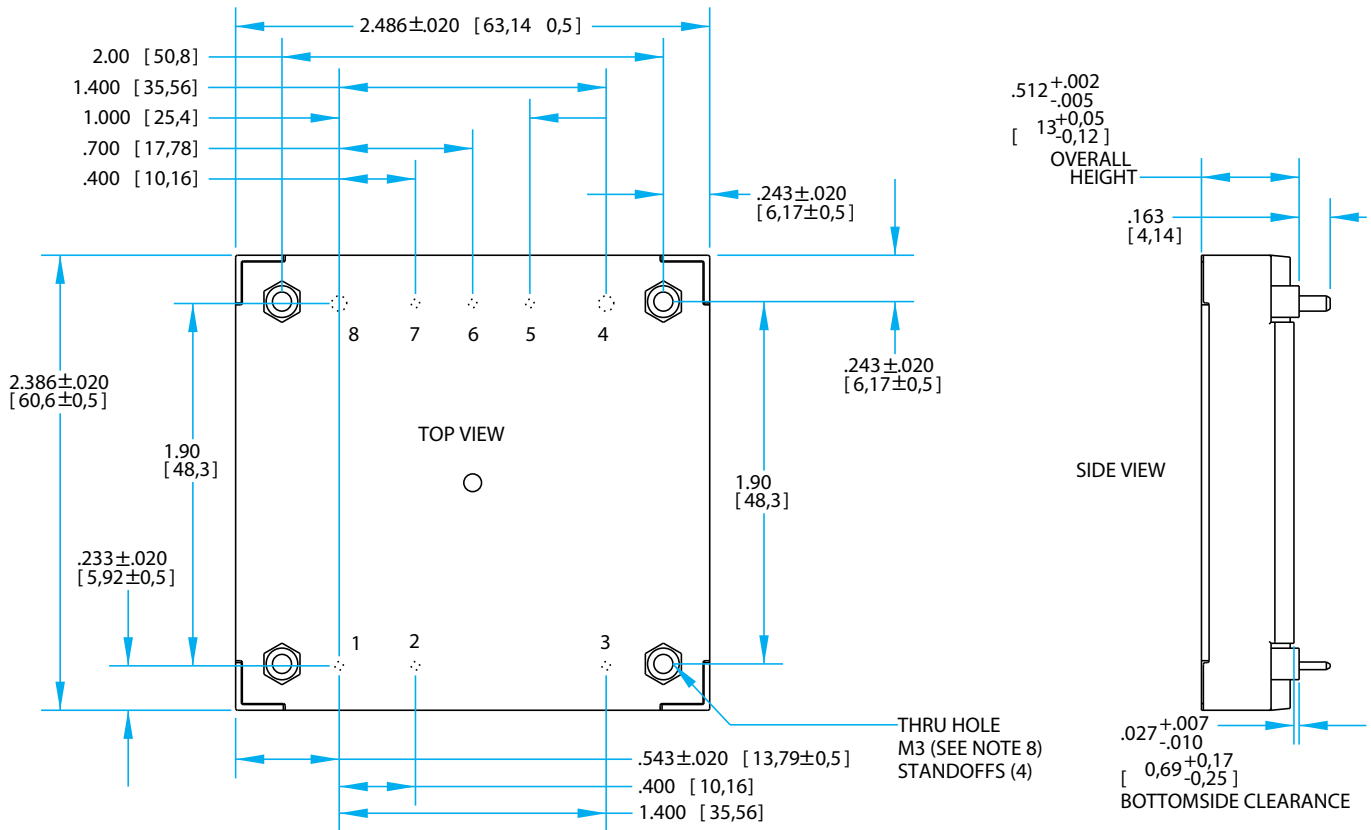

NOTES

- Applied torque per screw should not exceed 6in-lb. (0.7 Nm).
- Baseplate flatness tolerance is 0.004" (.10 mm) TIR for surface.
- Pins 1-3, 5-7 are 0.040" (1.02mm) diameter, with 0.080" (2.03mm) diameter standoff shoulders.
- Pins 4 and 8 are 0.080" (2.03 mm) dia. with 0.125" (3.18 mm) dia. standoff shoulders
- All Pins: Material: Copper Alloy
Finish: Matte Tin over Nickel plate
- Undimensioned Components are shown for visual reference only
- Weight: 4.9 oz (139 g)
- Threaded or Non-Threaded options available
- All dimensions in inches (mm) Tolerances:
x.xx +/-0.02 in. (x.x +/-0.5mm)
x.xxx +/-0.010 in. (x.xx +/-0.25mm)

PIN DESIGNATIONS

Pin	Name	Function
1	Vin(+)	Positive input voltage
2	ON/OFF	TTL input to turn converter on and off, referenced to Vin(-), with internal pull up.
3	Vin(-)	Negative input voltage
4	Vout(-)	Negative output voltage
5	SENSE(-)	Negative remote sense(see note 1)
6	TRIM	Output voltage trim (see note 2)
7	SENSE(+)	Positive remote sense (see note 3)
8	Vout(+)	Positive output voltage

Notes:

- SENSE(-) should be connected to Vout(-) either remotely or at the converter.
- Leave TRIM pin open for nominal output voltage.
- SENSE(+) should be connected to Vout(+) either remotely or at the converter.

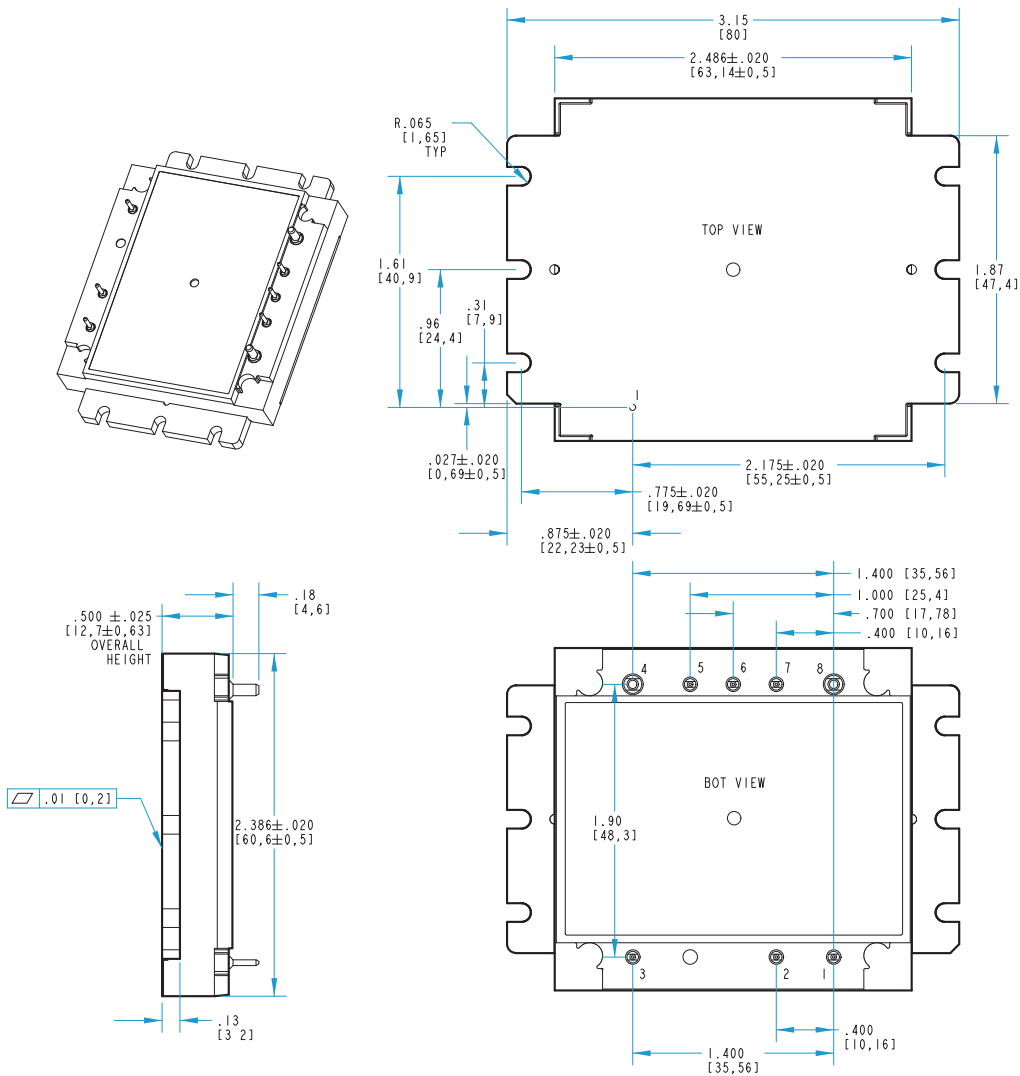

NOTES

- Applied torque per screw should not exceed 5in-lb. (3in-lb recommended).
- Baseplate flatness tolerance is 0.01" (.25 mm) TIR for surface.
- Pins 1-3, 5-7 are 0.040" (1.02mm) diameter, with 0.080" (2.03mm) diameter standoff shoulders.
- Pins 4 and 8 are 0.080" (2.03 mm) dia. with 0.125" (3.18 mm) dia. standoff shoulders
- All Pins: Material: Copper Alloy
Finish: Matte Tin over Nickel plate
- Undimensioned Components are shown for visual reference only
- Weight: 4.8 oz (137g)
- All dimensions in inches (mm) Tolerances:
x.xx +/-0.02 in. (x.x +/-0.5mm)
x.xxx +/-0.010 in. (x.xx +/-0.25mm)

PIN DESIGNATIONS

Pin	Name	Function
1	Vin(+)	Positive input voltage
2	ON/OFF	TTL input to turn converter on and off, referenced to Vin(-), with internal pull up.
3	Vin(-)	Negative input voltage
4	Vout(-)	Negative output voltage
5	SENSE(-)	Negative remote sense(see note 1)
6	TRIM	Output voltage trim (see note 2)
7	SENSE(+)	Positive remote sense (see note 3)
8	Vout(+)	Positive output voltage

Notes:

- SENSE(-) should be connected to Vout(-) either remotely or at the converter.
- Leave TRIM pin open for nominal output voltage.
- SENSE(+) should be connected to Vout(+) either remotely or at the converter.

PART NUMBERING SYSTEM

The part numbering system for SynQor's dc-dc converters follows the format shown in the example below.

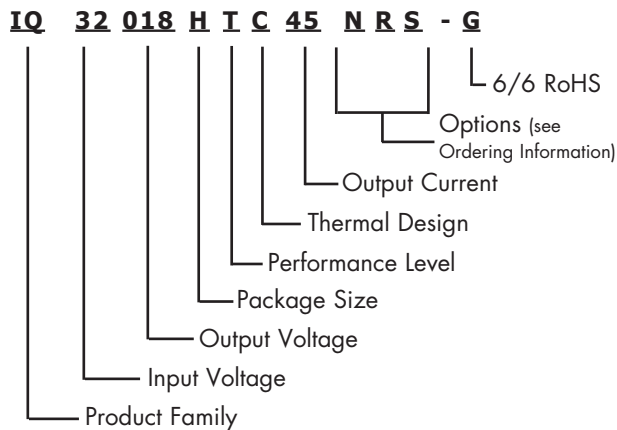

The first 12 characters comprise the base part number and the last 3 characters indicate available options. The "-G" suffix indicates 6/6 RoHS compliance.

Application Notes

A variety of application notes and technical white papers can be downloaded in pdf format from our [website](#).

RoHS Compliance: The EU led RoHS (Restriction of Hazardous Substances) Directive bans the use of Lead, Cadmium, Hexavalent Chromium, Mercury, Polybrominated Biphenyls (PBB), and Polybrominated Diphenyl Ether (PBDE) in Electrical and Electronic Equipment. This SynQor product is 6/6 RoHS compliant. For more information please refer to SynQor's RoHS addendum available at our [RoHS Compliance / Lead Free Initiative web page](#) or e-mail us at rohs@synqor.com.

Contact SynQor for further information:

Phone: 978-849-0600
Toll Free: 888-567-9596
Fax: 978-849-0602
E-mail: power@synqor.com
Web: www.synqor.com
Address: 155 Swanson Road
 Boxborough, MA 01719
 USA

ORDERING INFORMATION

The tables below show the valid model numbers and ordering options for converters in this product family. When ordering SynQor converters, please ensure that you use the complete 15 character part number consisting of the 12 character base part number and the additional characters for options. Add "-G" to the model number for 6/6 RoHS compliance.

Model Number	Input Voltage	Output Voltage	Max Output Current
IQ32018HTw45NRS	9-75V	1.8V	45A
IQ32033HTw33NRS	9-75V	3.3V	33A
IQ32050HTw24NRS	9-75V	5V	24A
IQ32120HTw10NRS	9-75V	12V	10A
IQ32150HTw08NRS	9-75V	15V	8A
IQ32240HTw05NRS	9-75V	24V	5A
IQ32280HTw05NRS	9-75V	28V	4.5A
IQ32400HTw03NRS	9-75V	40V	3A
IQ32480HTw03NRS	9-75V	48V	2.5A

The following options must be included in place of the **wxyz** spaces in the model numbers listed above.

Options Description			
Thermal Design	Enable Logic	Pin Style	Feature Set
C - Encased D - Encased with Non-Threaded Baseplate V - Encased with Flanged Baseplate	N - Negative	R - 0.180"	S - Standard

Not all combinations make valid part numbers, please contact SynQor for availability. See the [Product Summary web page](#) for more options.

PATENTS

SynQor holds the following U.S. patents, one or more of which apply to each product listed in this document. Additional patent applications may be pending or filed in the future.

5,999,417	6,222,742	6,545,890	6,577,109	6,594,159
6,731,520	6,894,468	6,896,526	6,927,987	7,050,309
7,072,190	7,085,146	7,119,524	7,269,034	7,272,021
7,272,023	7,558,083	7,564,702		

Warranty

SynQor offers a two (2) year limited warranty. Complete warranty information is listed on our website or is available upon request from SynQor.

Information furnished by SynQor is believed to be accurate and reliable. However, no responsibility is assumed by SynQor for its use, nor for any infringements of patents or other rights of third parties which may result from its use. No license is granted by implication or otherwise under any patent or patent rights of SynQor.