

## FEATURES

- *Guaranteed*  $25\mu\text{V}$  max. Offset Voltage
- *Guaranteed*  $0.6\mu\text{V}/^\circ\text{C}$  max. Offset Voltage Drift with Temperature
- *Excellent*  $1.0\mu\text{V}/\text{Month}$  max. Long Term Stability
- *Guaranteed*  $0.6\mu\text{V}_{\text{p-p}}$  max. Noise
- *Guaranteed*  $2.0\text{nA}$  max. Input Bias Current

## APPLICATIONS

- Thermocouple Amplifiers
- Strain Gauge Amplifiers
- Low Level Signal Processing
- Medical Instrumentation

## DESCRIPTION

The OP-07 offers excellent performance in applications requiring low offset voltage, low drift with time and temperature and very low noise. Linear's OP-07 is interchangeable with many of the precision op-amp device types. The OP-07 also offers a wide input voltage range, high common mode rejection and low input bias current. These features result in optimum performance for small signal level and low frequency applications. Use of advanced design, processing and testing techniques make Linear's OP-07 a superior choice over similar products. A buffered reference application is shown below. For single op amp applications requiring higher performance, see the **LT1001** and for matched dual precision applications see the **LT1002**.

Precision Buffered Single Supply Reference

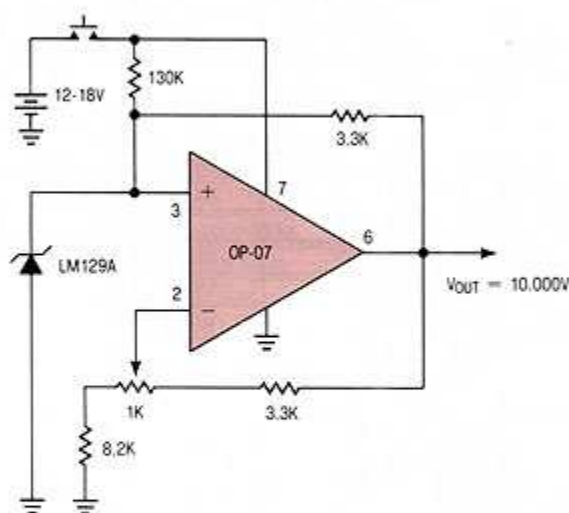

The OP-07 contributes less than 5% of the total drift with temperature, noise and long term drift of the reference application.

Offset Voltage Drift With Temperature  
 Of Representative Units

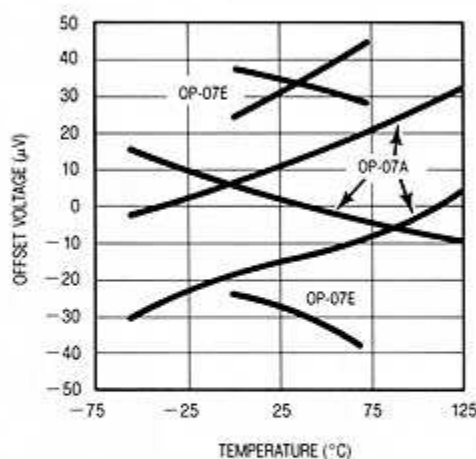

**ABSOLUTE MAXIMUM RATINGS**

Supply Voltage..... ±22V  
 Differential Input Voltage..... ±30V  
 Input Voltage Equal to Supply Voltage  
 Output Short Circuit Duration..... Indefinite  
 Operating Temperature Range  
   OP-07/OP-07A..... -55°C to 125°C  
   OP-07E/OP-07C..... 0°C to 70°C  
 Storage Temperature Range  
   All Devices..... -65°C to 150°C  
 Lead Temperature (Soldering, 10 sec.)..... 300°C

**PACKAGE/ORDER INFORMATION**

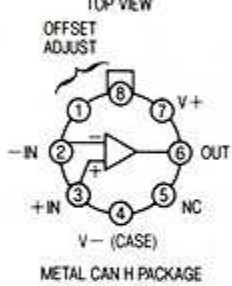
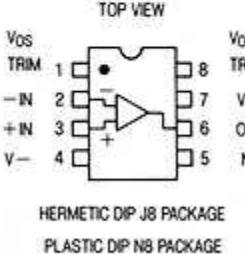
TOP VIEW OFFSET ADJUST 	ORDER PART NO.	OFFSET VOLTAGE (MAX)
	OP-07AH OP-07H OP-07EH OP-07CH	25µV 75µV 75µV 150µV
TOP VIEW 	OP-07AJ8 OP-07J8 OP-07EJ8 OP-07CJ8 OP-07EN8 OP-07CN8	25µV 75µV 75µV 150µV 75µV 150µV

**ELECTRICAL CHARACTERISTICS**  $V_S = \pm 15V, T_A = 25^\circ C$ , unless otherwise noted.

SYMBOL	PARAMETER	CONDITIONS	OP-07A			OP-07			UNITS
			MIN	TYP	MAX	MIN	TYP	MAX	
$V_{OS}$	Input Offset Voltage	(Note 1)		10	25		30	75	µV
$\frac{\Delta V_{OS}}{\Delta Time}$	Long Term Input Offset Voltage Stability	(Notes 2 and 3)		0.2	1.0		0.2	1.0	µV/Month
$I_{OS}$	Input Offset Current			0.3	2.0		0.4	2.8	nA
$I_B$	Input Bias Current			±0.7	±2.0		±1.0	±3.0	nA
$e_n$	Input Noise Voltage	0.1Hz to 10Hz (Note 2)		0.35	0.6		0.35	0.6	µV <sub>rms</sub>
	Input Noise Voltage Density	$f_o = 10Hz$ $f_o = 100Hz$ (Note 2) $f_o = 1000Hz$		10.3	18.0		10.3	18.0	nV/√Hz
				10.0	13.0		10.0	13.0	
				9.6	11.0		9.6	11.0	
$i_n$	Input Noise Current	0.1Hz to 10Hz (Note 2)		14	30		14	30	pA <sub>rms</sub>
	Input Noise Current Density	$f_o = 10Hz$ $f_o = 100Hz$ (Note 2) $f_o = 1000Hz$		0.32	0.80		0.32	0.80	pA/√Hz
				0.14	0.23		0.14	0.23	
				0.12	0.17		0.12	0.17	
$R_{in}$	Input Resistance Differential Mode	(Note 4)	30	80		20	60		MΩ
	Input Resistance Common Mode			200			200		GΩ
	Input Voltage Range		±13.5	±14.0		±13.5	±14.0		V
CMRR	Common Mode Rejection Ratio	$V_{CM} = \pm 13V$	110	126		110	126		dB
PSRR	Power Supply Rejection Ratio	$V_S = \pm 3V$ to $\pm 18V$	100	108		100	108		dB
$A_{VOL}$	Large Signal Voltage Gain	$R_L \geq 2k\Omega, V_o = \pm 10V$ $R_L \geq 500\Omega, V_o = \pm 0.5V$ $V_S = \pm 3V$ (Note 4)	300	500		200	500		V/mV
			150	400		150	400		
$V_{OUT}$	Maximum Output Voltage Swing	$R_L \geq 10k\Omega$ $R_L \geq 2k\Omega$ $R_L \geq 1k\Omega$	±12.5	±13.0		±12.5	±13.0		V
			±12.0	±12.8		±12.0	±12.8		
			±10.5	±12.0		±10.5	±12.0		
SR	Slew Rate	$R_L \geq 2k\Omega$ (Note 4)	0.1	0.25		0.1	0.25		V/µS
GBW	Closed Loop Bandwidth	$A_{VCL} = +1$ (Note 4)	0.4	0.6		0.4	0.6		MHz
$Z_o$	Open Loop Output Impedance	$V_o = 0, I_o = 0, f = 10Hz$		60			60		Ω
$P_d$	Power Dissipation	$V_S = \pm 15V$ $V_S = \pm 3V$		75	120		75	120	mW
				4	6		4	6	
	Offset Adjustment Range	Null Pot = 20kΩ		±4			±4		mV

See Notes on page 4.

## ELECTRICAL CHARACTERISTICS $V_S = \pm 15V$ , $-55^\circ C \leq T_A \leq 125^\circ C$ , unless otherwise noted.

SYMBOL	PARAMETER	CONDITIONS	OP-07A			OP-07			UNITS
			MIN	TYP	MAX	MIN	TYP	MAX	
$V_{OS}$	Input Offset Voltage	(Note 1)	●	25	60		60	200	$\mu V$
$\frac{\Delta V_{OS}}{\Delta Temp}$	Average Input Offset Voltage Drift Without External Trim With External Trim	Null Pot = 20k $\Omega$ (Note 2)	●	0.2 0.2	0.6 0.6		0.3 0.3	1.3 1.3	$\mu V/^\circ C$
$I_{OS}$	Input Offset Current		●	0.8	4.0		1.2	5.6	nA
$\frac{\Delta I_{OS}}{\Delta Temp}$	Average Input Offset Current Drift	(Note 2)	●	5	25		8	50	pA/°C
$I_B$	Input Bias Current		●	$\pm 1.0$	$\pm 4.0$		$\pm 2.0$	$\pm 6.0$	nA
$\frac{\Delta I_B}{\Delta Temp}$	Average Input Bias Current Drift	(Note 2)	●	8	25		13	50	pA/°C
	Input Voltage Range		●	$\pm 13.0$	$\pm 13.5$		$\pm 13.0$	$\pm 13.5$	V
CMRR	Common Mode Rejection Ratio	$V_{CM} = \pm 13V$	●	106	123		106	123	dB
PSRR	Power Supply Rejection Ratio	$V_S = \pm 3V$ to $\pm 18V$	●	94	106		94	106	dB
$A_{VOL}$	Large Signal Voltage Gain	$R_L \geq 2k\Omega$ , $V_O = \pm 10V$	●	200	400		150	400	V/mV
$V_{OUT}$	Output Voltage Swing	$R_L \geq 2k\Omega$	●	$\pm 12.0$	$\pm 12.6$		$\pm 12.0$	$\pm 12.6$	V

## ELECTRICAL CHARACTERISTICS $V_S = \pm 15V$ , $T_A = 25^\circ C$ , unless otherwise noted.

SYMBOL	PARAMETER	CONDITIONS	OP-07E			OP-07C			UNITS
			MIN	TYP	MAX	MIN	TYP	MAX	
$V_{OS}$	Input Offset Voltage	(Note 1)		30	75		60	150	$\mu V$
$\frac{\Delta V_{OS}}{\Delta Time}$	Long Term Input Offset Voltage Stability	(Notes 2 and 3)		0.3	1.5		0.4	2.0	$\mu V/$ Month
$I_{OS}$	Input Offset Current			0.5	3.8		0.8	6.0	nA
$I_B$	Input Bias Current			$\pm 1.2$	$\pm 4.0$		$\pm 1.8$	$\pm 7.0$	nA
$e_n$	Input Noise Voltage	0.1Hz to 10Hz (Note 2)		0.35	0.6		0.35	0.65	$\mu V_{P-P}$
	Input Noise Voltage Density	$f_o = 10Hz$ $f_o = 100Hz$ (Note 2) $f_o = 1000Hz$		10.3 10.0 9.6	18.0 13.0 11.0		10.5 10.2 9.8	20.0 13.5 11.5	nV/ $\sqrt{Hz}$
$I_n$	Input Noise Current	0.1Hz to 10Hz (Note 2)		14	30		15	35	pA $_{P-P}$
	Input Noise Current Density	$f_o = 10Hz$ $f_o = 100Hz$ (Note 2) $f_o = 1000Hz$		0.32 0.14 0.12	0.80 0.23 0.17		0.32 0.15 0.13	0.90 0.27 0.18	pA/ $\sqrt{Hz}$
$R_{in}$	Input Resistance Differential Mode	(Note 4)		15	50		8	33	M $\Omega$
	Input Resistance Common Mode				160			120	G $\Omega$
	Input Voltage Range			$\pm 13.5$	$\pm 14.0$		$\pm 13.0$	$\pm 14.0$	V
CMRR	Common Mode Rejection Ratio	$V_{CM} = \pm 13V$		106	123		100	120	dB
PSRR	Power Supply Rejection Ratio	$V_S = \pm 3V$ to $\pm 18V$		94	106		90	104	dB
$A_{VOL}$	Large Signal Voltage Gain	$R_L \geq 2k\Omega$ , $V_O = \pm 10V$ $R_L \geq 500\Omega$ , $V_O = \pm 0.5V$ $V_S = \pm 3V$ (Note 4)		200 150	500 400		120 100	400 400	V/mV
$V_O$	Maximum Output Voltage Swing	$R_L \geq 10k\Omega$ $R_L \geq 2k\Omega$ $R_L \geq 1k\Omega$		$\pm 12.5$ $\pm 12.0$ $\pm 10.5$	$\pm 13.0$ $\pm 12.8$ $\pm 12.0$		$\pm 12.5$ $\pm 11.5$ $\pm 12.0$	$\pm 13.0$ $\pm 12.8$ $\pm 12.0$	V
SR	Slewing Rate	$R_L \geq 2k\Omega$ (Note 2)		0.1	0.25		0.1	0.25	V/ $\mu S$
GBW	Closed Loop Bandwidth	$A_{VCL} = +1$ (Note 2)		0.4	0.6		0.4	0.6	MHz
$Z_o$	Open Loop Output Impedance	$V_O = 0$ , $I_O = 0$ , $f = 10Hz$			60			60	$\Omega$
$P_d$	Power Dissipation	$V_S = \pm 15V$ , $V_S = \pm 3V$		75 4	120 6		80 4	150 8	mW mW
	Offset Adjustment Range	Null Pot = 20k $\Omega$		$\pm 4$			$\pm 4$		mV

See Notes on page 4.

**ELECTRICAL CHARACTERISTICS**  $V_S = \pm 15V$ ,  $0^\circ C \leq T_A \leq 70^\circ C$ , unless otherwise noted.

SYMBOL	PARAMETER	CONDITIONS	OP-07E			OP-07C			UNITS
			MIN	TYP	MAX	MIN	TYP	MAX	
$V_{OS}$	Input Offset Voltage		●	45	130	85	250	$\mu V$	
$\frac{\Delta V_{OS}}{\Delta Temp}$	Average Input Offset Voltage Drift Without External Trim With External Trim	Null Pot = 20k $\Omega$ (Note 2)	●	0.3 0.3	1.3 1.3	0.5 0.4	1.8 1.6	$\mu V/^\circ C$	
$I_{OS}$	Input Offset Current		●	0.9	5.3	1.6	8.0	nA	
$\frac{\Delta I_{OS}}{\Delta Temp}$	Average Input Offset Current Drift	(Note 2)	●	8	35	12	50	pA/°C	
$I_B$	Input Bias Current		●	$\pm 1.5$	$\pm 5.5$	$\pm 2.2$	$\pm 9.0$	nA	
$\frac{\Delta I_B}{\Delta Temp}$	Average Input Bias Current Drift	(Note 2)	●	13	35	18	50	pA/°C	
	Input Voltage Range		●	$\pm 13.0$	$\pm 13.5$	$\pm 13.0$	$\pm 13.5$	V	
CMRR	Common Mode Rejection Ratio	$V_{CM} = \pm 13V$	●	103	123	97	120	dB	
PSRR	Power Supply Rejection Ratio	$V_S = \pm 3V$ to $\pm 18V$	●	90	104	86	100	dB	
$A_{VOL}$	Large Signal Voltage Gain	$R_L \geq 2k\Omega$ , $V_o = \pm 10V$	●	180	450	100	400	V/mV	
$V_{OUT}$	Output Voltage Swing	$R_L \geq 2k\Omega$	●	$\pm 12.0$	$\pm 12.6$	$\pm 11.0$	$\pm 12.6$	V	

The ● denotes the specifications which apply over full operating temperature range.

For MIL-STD components, please refer to LTC 883C data sheet for test listing and parameters.

**Note 1:** Offset voltage for the OP-07A is measured 60 seconds after power is applied. All other grades are measured with high speed test equipment, approximately 1 second after power is applied.

**Note 2:** This parameter is tested on a sample basis only.

**Note 3:** Long term Input Offset Voltage Stability refers to the averaged trend line of  $V_{OS}$  versus Time over extended periods after the first 30 days of operation. Excluding the initial hour of operation, changes in  $V_{OS}$  during the first 30 operating days are typically  $2.5\mu V$ .

**Note 4:** This parameter is guaranteed by design.

**Note 5:** The OP-07D is available by special request.

# TYPICAL PERFORMANCE CHARACTERISTICS

**Low Frequency Noise  
(Closed Loop Gain = 25,000)**

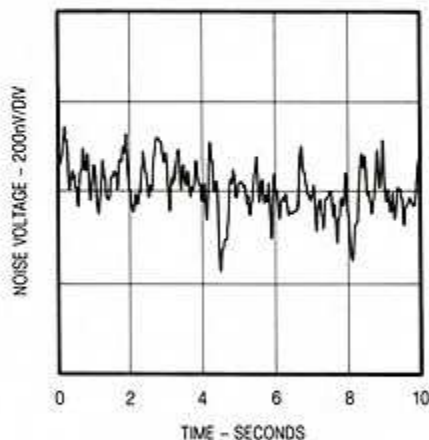

**Total Input Noise Voltage  
vs Frequency**

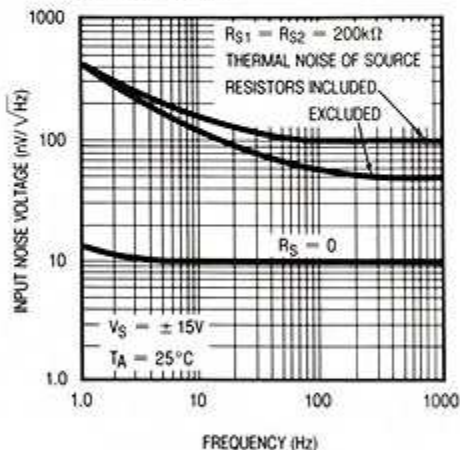

**Open-Loop  
Frequency Response**

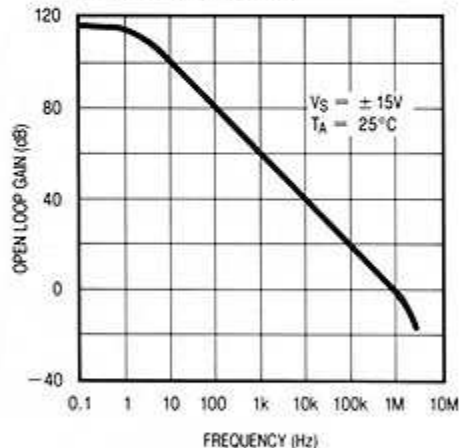

**Common Mode Rejection Ratio  
vs Frequency**

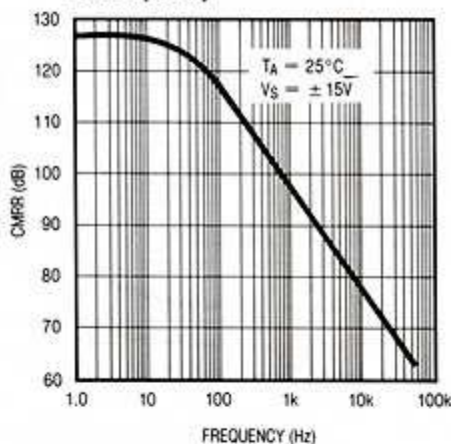

**Power Supply Rejection Ratio  
vs Frequency**

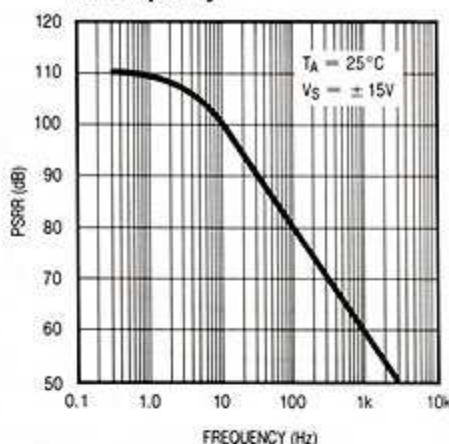

**Long Term Stability of Four  
Representative Units**

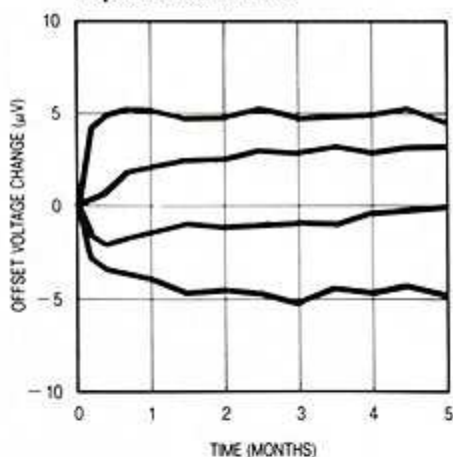

**Warm-Up Drift**

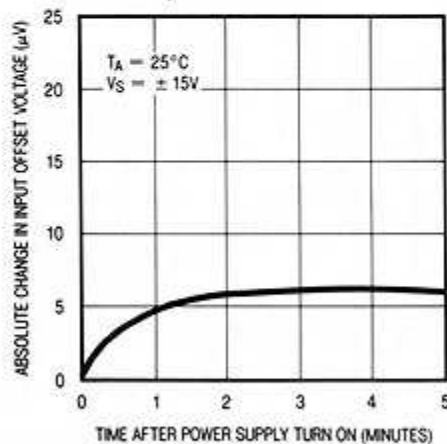

**Offset Voltage Change Due  
to Thermal Shock**

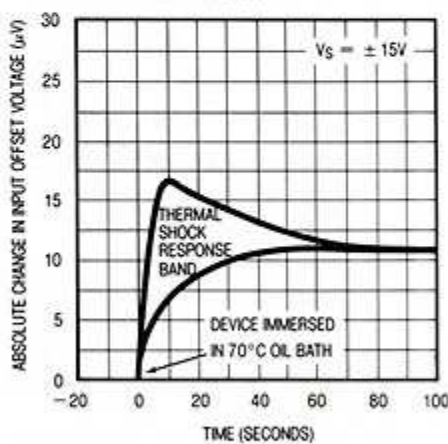

**Open-Loop Gain vs  
Temperature**

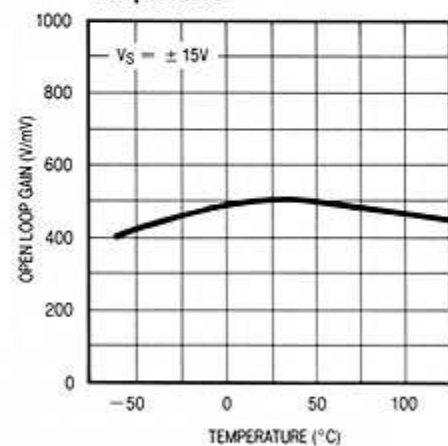

# TYPICAL PERFORMANCE CHARACTERISTICS

**Input Bias Current vs Temperature**

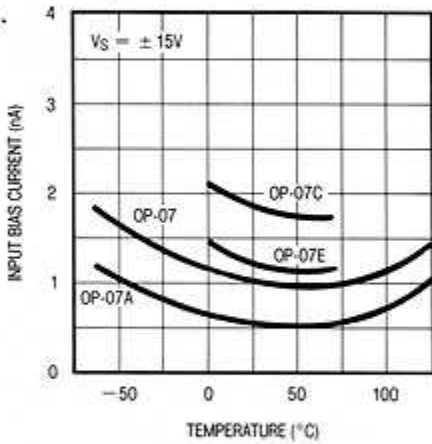

**Input Offset Current vs Temperature**

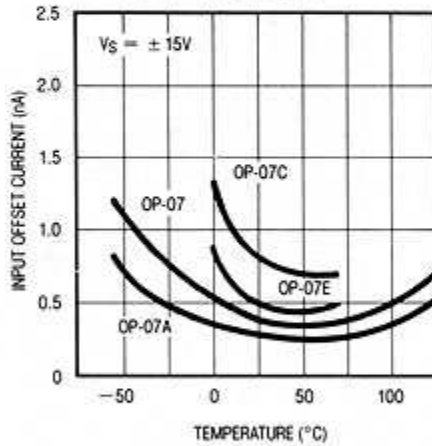

**Input Bias Current vs Differential Input Voltage**

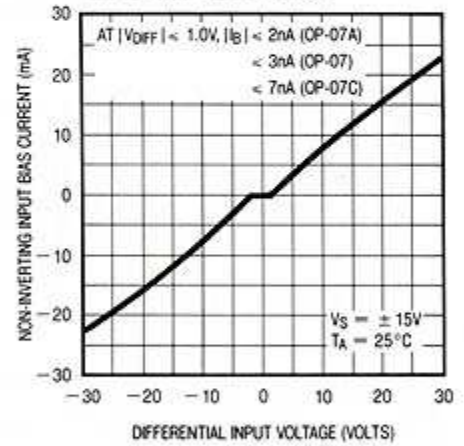

**Maximum Error vs Source Resistance**

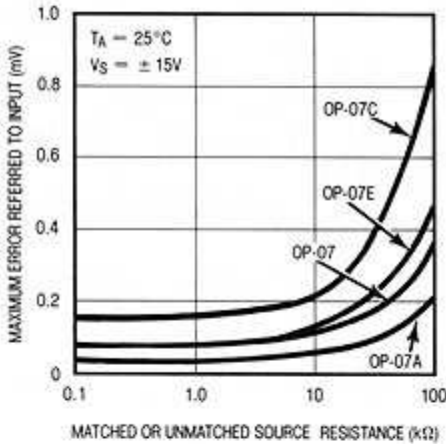

**Maximum Error vs Source Resistance**

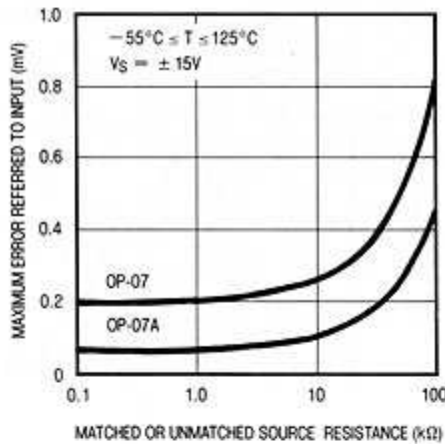

**Maximum Error vs Source Resistance**

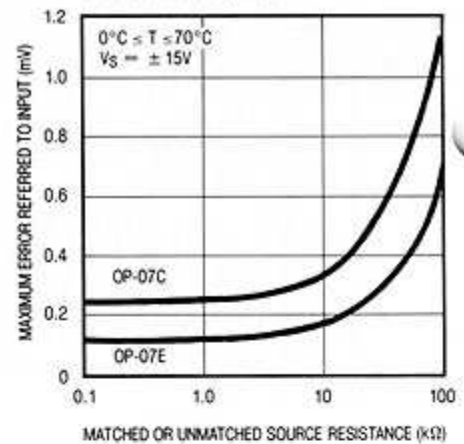

**Output Voltage vs Load Resistance**

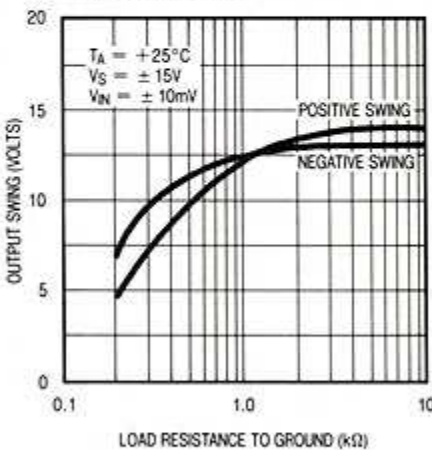

**Power Consumption vs Power Supply**

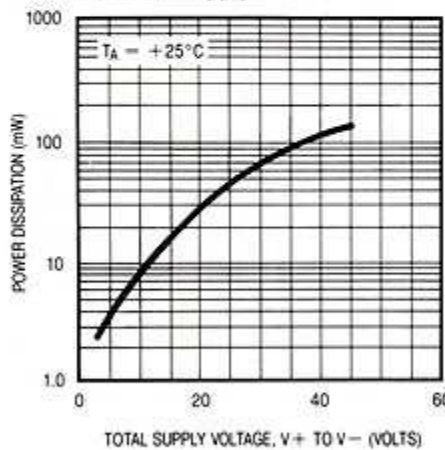

**Output Short-Circuit Current vs Time**

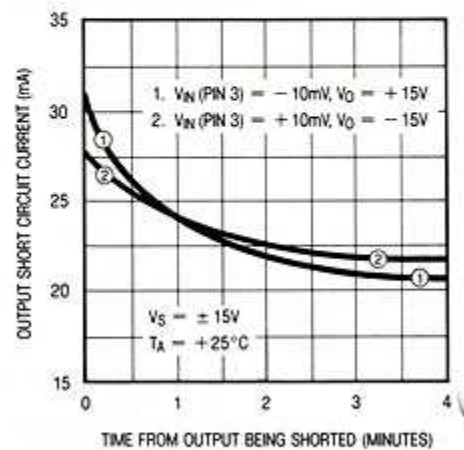

# TYPICAL APPLICATIONS

Precision Summing Amplifier

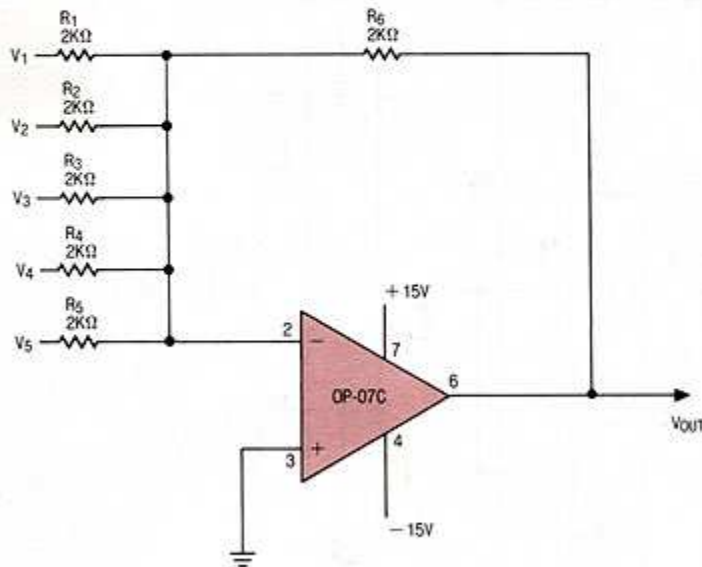

Instrumentation Amplifier

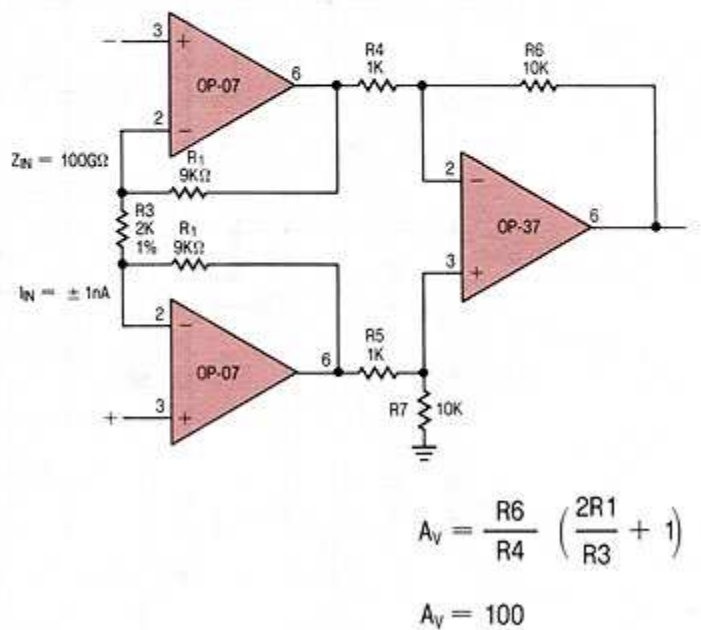

# TEST CIRCUIT DIAGRAMS

Offset Voltage Test Circuit †

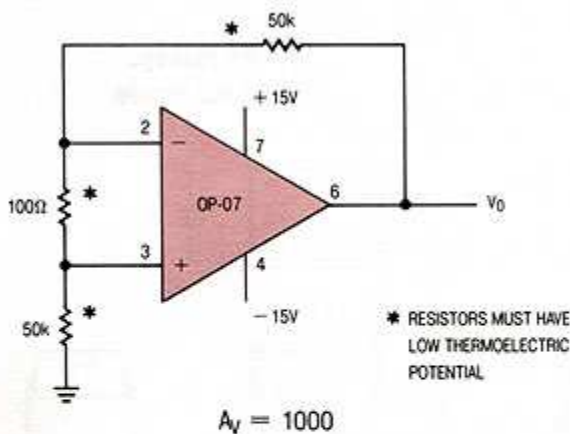

Offset Nulling and Low Frequency Noise Test Circuit

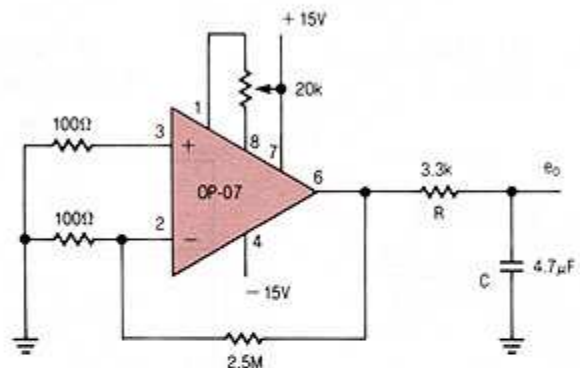

- NOTES:
- 1) RC APPROXIMATELY 10Hz FILTER
  - 2) OBSERVE OUTPUT FOR 10 SECONDS  
 $A_V = 25000$

Application Tip:

When the OP-07 is used as a replacement in 725, 108/108A, 308/308A applications, removal of external compensation is optional. For conventionally nulled 741 type applications, external trimming should be removed. Care should be taken to avoid thermocouple voltages caused by temperature variations between the input terminals or dissimilar metals.

† This circuit is also used as the burn-in configuration with supply voltages changed to ± 20 Volts.

# SCHEMATIC DIAGRAM

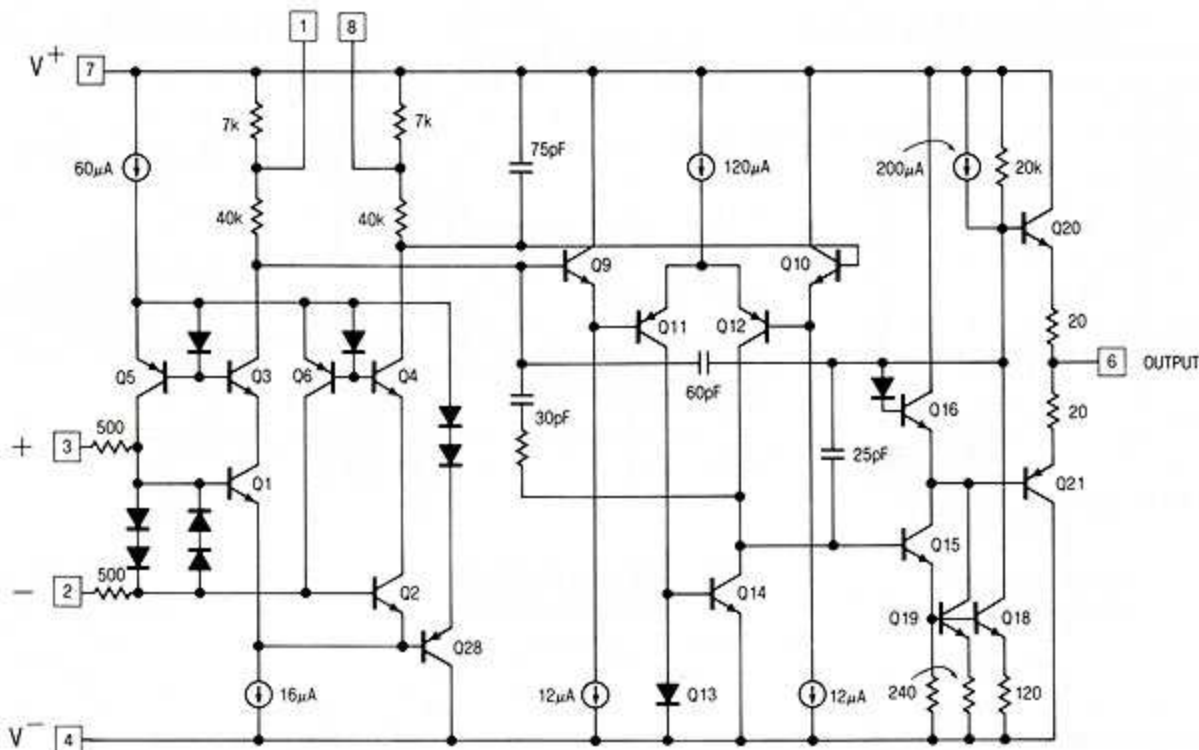

# PACKAGE DESCRIPTION

**H Package**  
Metal Can

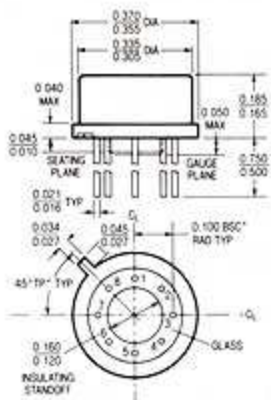

NOTE: DIMENSIONS IN INCHES

$T_{jmax}$	$\theta_{ja}$	$\theta_{jc}$
150°C	150°C/W	45°C/W

**J8 Package**  
8 Lead Hermetic Dip

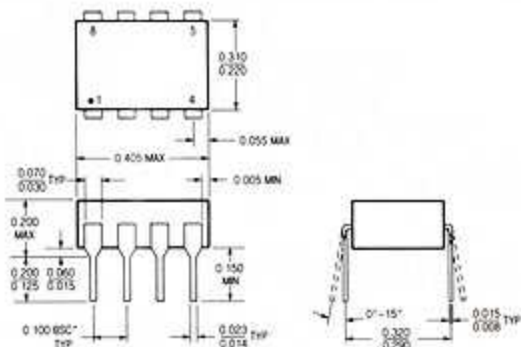

NOTE: DIMENSIONS IN INCHES UNLESS OTHERWISE NOTED  
\*LEADS WITHIN 0.007 OF TRUE POSITION (TYP) AT GAUGE PLANE

$T_{jmax}$	$\theta_{ja}$
150°C	100°C/W

**N8 Package**  
8 Lead Plastic

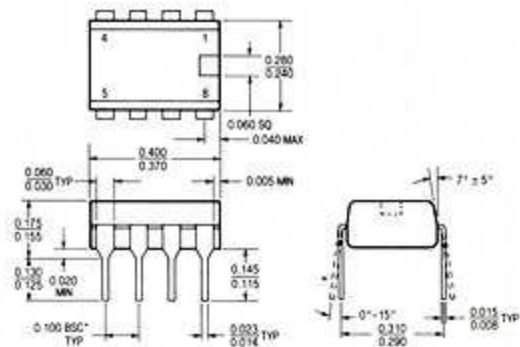

NOTE: DIMENSIONS IN INCHES UNLESS OTHERWISE NOTED  
\*LEADS WITHIN 0.007 OF TRUE POSITION (TYP) AT GAUGE PLANE

$T_{jmax}$	$\theta_{ja}$
100°C	130°C/W