



## ABSOLUTE MAXIMUM RATINGS

(Note 1)

Supply Voltage .....	18V
Power Dissipation .....	500mW
Operating Temperature Range	
LTC1059C .....	$-40^{\circ}\text{C} \leq T_A \leq 85^{\circ}\text{C}$
LTC1059AM, LTC1059M .....	$-55^{\circ}\text{C} \leq T_A \leq 125^{\circ}\text{C}$
Storage Temperature Range .....	$-65^{\circ}\text{C}$ to $150^{\circ}\text{C}$
Lead Temperature (Soldering, 10 sec).....	300°C

## PACKAGE/ORDER INFORMATION

	<b>ORDER PART NUMBER</b>  LTC1059CN LTC1059CS
N PACKAGE 14-LEAD PDIP $T_{JMAX} = 110^{\circ}\text{C}$ , $\theta_{JA} = 130^{\circ}\text{C/W}$ (N) $T_{JMAX} = 110^{\circ}\text{C}$ , $\theta_{JA} = 110^{\circ}\text{C/W}$ (S)	S PACKAGE 14-LEAD PLASTIC SO $T_{JMAX} = 110^{\circ}\text{C}$ , $\theta_{JA} = 110^{\circ}\text{C/W}$ (S)
J PACKAGE 14-LEAD CERDIP $T_{JMAX} = 150^{\circ}\text{C}$ , $\theta_{JA} = 80^{\circ}\text{C/W}$  <b>OBSOLETE PACKAGE</b> Consider the N or S Package for Alternate Source	
LTC1059ACJ LTC1059AMJ LTC1059CJ LTC1059MJ	

Consult LTC Marketing for parts specified with wider operating temperature ranges.

## ELECTRICAL CHARACTERISTICS

The ● denotes the specifications which apply over the full operating temperature range, otherwise specifications are at  $T_A = 25^{\circ}\text{C}$ .

(Complete Filter)  $V_S = \pm 5\text{V}$ ,  $T^2L$  clock input level unless otherwise specified.

PARAMETER	CONDITIONS	MIN	TYP	MAX	UNITS
Center Frequency Range, $f_0$	$f_0 \bullet Q \leq 400\text{kHz}$ , Mode 1		0.1 - 40k		Hz
	$f_0 \bullet Q \leq 1.6\text{MHz}$ , Mode 1		0.1 - 18k		Hz
	$f_0 \bullet Q \leq 250\text{kHz}$ , Mode 3, $V_S = \pm 7.5\text{V}$		0.1 - 20k		Hz
	$f_0 \bullet Q \leq 1\text{MHz}$ , Mode 3, $V_S = \pm 7.5\text{V}$		0.1 - 16k		Hz
Input Frequency Range			0 - 200k		Hz
Clock-to-Center Frequency Ratio	Mode 1, 50:1, $f_{CLK} = 250\text{kHz}$ , $Q = 10$	●		$50 \pm 0.8\%$	
	Mode 1, 100:1, $f_{CLK} = 500\text{kHz}$ , $Q = 10$	●		$100 \pm 0.8\%$	
Q Accuracy	Mode 1, 50:1 or 100:1, $f_0 = 5\text{kHz}$ $Q = 10$	●	$\pm 0.5$	5	%
$f_0$ Temperature Coefficient	Mode 1, $f_{CLK} < 500\text{kHz}$		5		ppm/°C
Q Temperature Coefficient	Mode 1, $f_{CLK} < 500\text{kHz}$ , $Q = 10$		15		ppm/°C
DC Offset	$V_{OS1}$	●	2	15	mV
	$V_{OS2}$	●	3	30	mV
	$V_{OS2}$	●	3	40	mV
	$V_{OS2}$	●	6	60	mV
	$V_{OS2}$	●	6	80	mV
	$V_{OS2}$	●	2	20	mV
	$V_{OS2}$	●	2	30	mV
	$V_{OS2}$	●	4	40	mV
	$V_{OS2}$	●	4	60	mV
	$V_{OS3}$	●	2	20	mV
	$V_{OS3}$	●	2	30	mV
	$V_{OS3}$	●	4	40	mV
	$V_{OS3}$	●	4	60	mV

## ELECTRICAL CHARACTERISTICS

The ● denotes the specifications which apply over the full operating temperature range, otherwise specifications are at  $T_A = 25^\circ\text{C}$ .

(Complete Filter)  $V_S = \pm 5\text{V}$ ,  $T^2\text{L}$  Clock Input Level unless otherwise specified.

PARAMETER	CONDITIONS	MIN	TYP	MAX	UNITS
DC Lowpass Gain Accuracy	Mode 1, $R_1 = R_2 = 50\text{k}\Omega$	●	$\pm 0.1$	2	%
BP Gain Accuracy at $f_0$	Mode 1, $Q = 10$ , $f_0 = 5\text{kHz}$		$\pm 0.1$		%
Clock Feedthrough	$f_{\text{CLK}} \leq 1\text{MHz}$		10		mV
Max Clock Frequency	Mode 1, $Q < 5$ , $V_S \geq \pm 5\text{V}$		2		MHz
Power Supply Current		●	3.5	5.5 7	mA mA

(Complete Filter)  $V_S = \pm 2.37\text{V}$  unless otherwise specified.

PARAMETER	CONDITIONS	MIN	TYP	MAX	UNITS
Center Frequency Range	$f_0 \cdot Q \leq 120\text{kHz}$ , Mode 1, 50:1 $f_0 \cdot Q \leq 120\text{kHz}$ , Mode 3, 50:1		0.1 - 12k 0.1 - 10k		Hz Hz
Input Frequency Range			60k		Hz
Clock-to-Center Frequency Ratio	Mode 1, 50:1, $f_{\text{CLK}} = 250\text{kHz}$ , $Q = 10$ Mode 1, 100:1, $f_{\text{CLK}} = 250\text{kHz}$ , $Q = 10$		$50 \pm 0.8\%$ $100 \pm 0.8\%$		
Q Accuracy	Mode 1, $f_{\text{CLK}} = 250\text{kHz}$ , $Q = 10$ 50:1 and 100:1		$\pm 2$		%
Max Clock Frequency			700		kHz
Power Supply Current			1.5	2.5	mA

(Internal Op Amps) The ● denotes the specifications which apply over the full operating temperature range, otherwise specifications are at  $T_A = 25^\circ\text{C}$ .

PARAMETER	CONDITIONS	MIN	TYP	MAX	UNITS
Supply Voltage Range		$\pm 2.375$		$\pm 8$	V
Voltage Swings	$V_S = \pm 5\text{V}$ , $R_L = 5\text{k}$ (Pins 1, 14) $R_L = 3.5\text{k}$ (Pins 2, 13)	●	$\pm 3.8$ $\pm 3.6$	$\pm 4.2$	V V
Input Offset Voltage		●	1	15	mV
Input Bias Current			3		pA
Output Short-Circuit Current Source/Sink	$V_S = \pm 5\text{V}$ (N Package) $V_S = \pm 5\text{V}$ (S Package)		40/3 25/3		mA mA
DC Open Loop Gain	$V_S = \pm 5\text{V}$		80		dB
GBW	$V_S = \pm 5\text{V}$		2		MHz
Slew Rate	$V_S = \pm 5\text{V}$		7		V/ $\mu\text{s}$

**Note 1:** Absolute Maximum Ratings are those values beyond which the life of a device may be impaired.

# TYPICAL PERFORMANCE CHARACTERISTICS

**Graph 1. Mode 1:  
( $f_{CLK}/f_0$ ) Deviation vs Q**

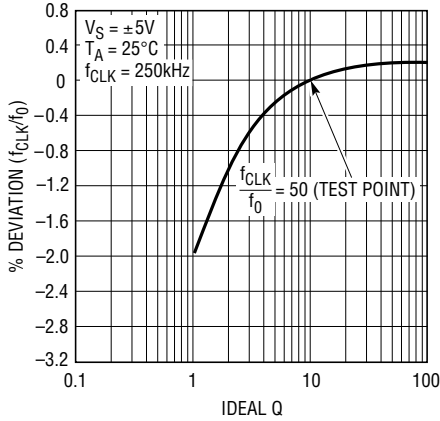

1060 G01

**Graph 2. Mode 1:  
( $f_{CLK}/f_0$ ) Deviation vs Q**

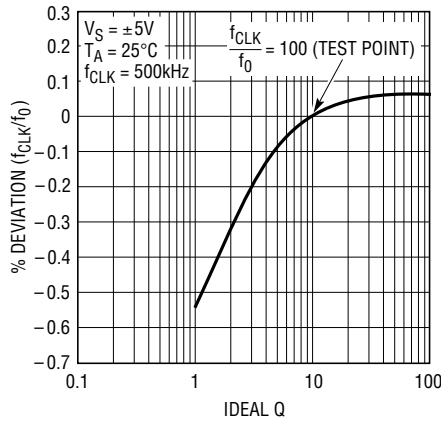

1060 G02

**Graph 3. Mode 1: Q Error  
vs Clock Frequency**

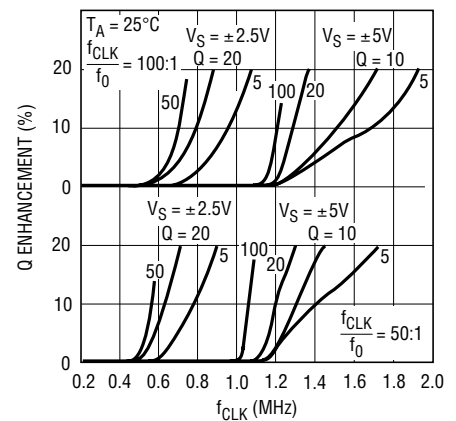

1060 G03

**Graph 4. Mode 1: Q Error  
vs Clock Frequency**

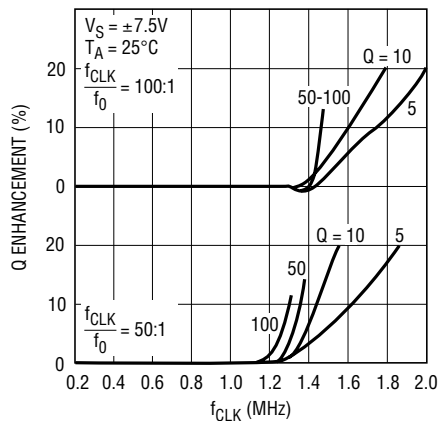

1059 G04

**Graph 5. Mode 1: Measured Q  
vs  $f_{CLK}$  and Temperature**

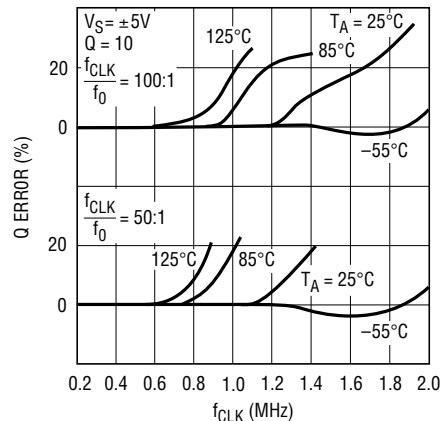

1059 G05

**Graph 6. Mode 1: ( $f_{CLK}/f_0$ )  
vs  $f_{CLK}$  and Q**

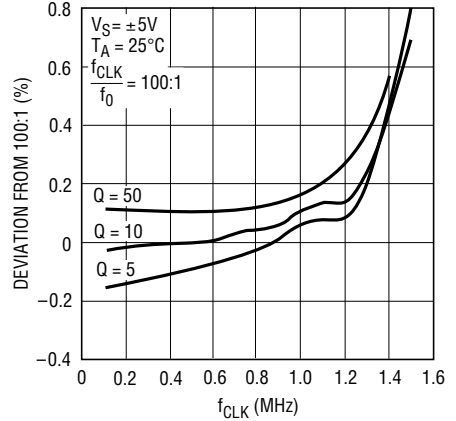

1059 G06

**Graph 7. Mode 1: ( $f_{CLK}/f_0$ )  
vs  $f_{CLK}$  and Q**

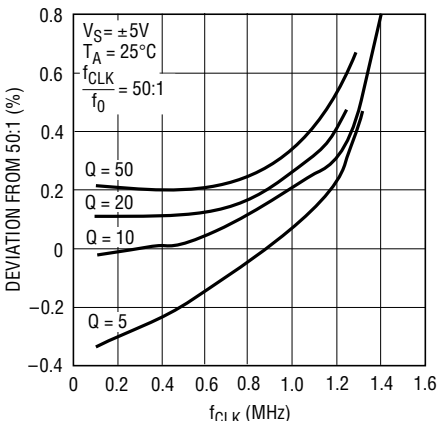

1059 G07

**Graph 8. Mode 1: ( $f_{CLK}/f_0$ )  
vs  $f_{CLK}$  and Temperature**

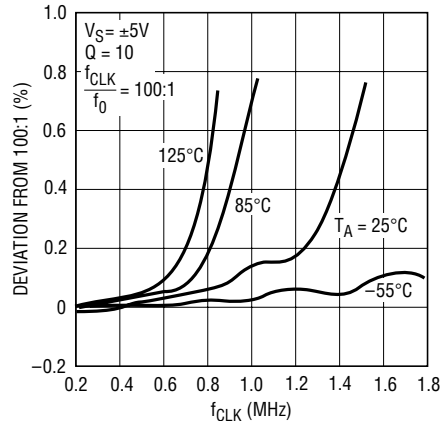

1059 G08

**Graph 9. Mode 1: ( $f_{CLK}/f_0$ )  
vs  $f_{CLK}$  and Temperature**

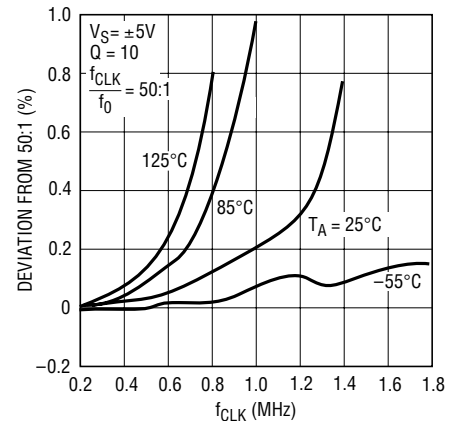

1059 G09

# TYPICAL PERFORMANCE CHARACTERISTICS

**Graph 10. Mode 1: ( $f_{CLK}/f_0$ ) vs  $f_{CLK}$  and Q**

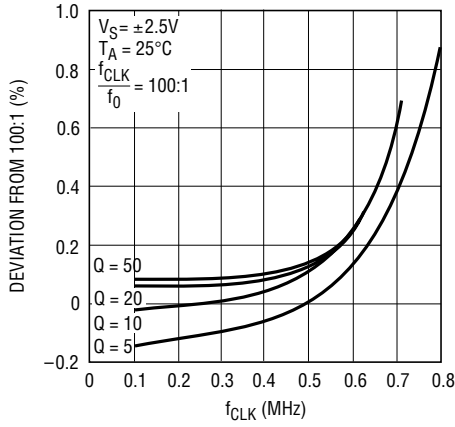

1059 G10

**Graph 11. Mode 1: ( $f_{CLK}/f_0$ ) vs  $f_{CLK}$  and Q**

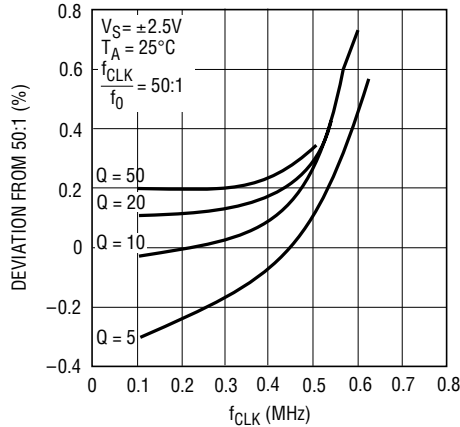

1059 G11

**Graph 12. Mode 1: ( $f_{CLK}/f_0$ ) vs  $f_{CLK}$  and Temperature**

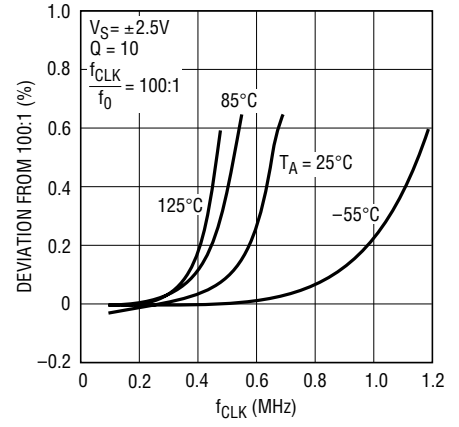

1059 • G12

**Graph 13. Mode 1: ( $f_{CLK}/f_0$ ) vs  $f_{CLK}$  and Temperature**

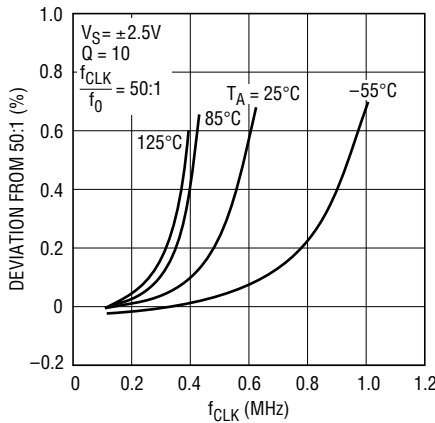

1059 G13

**Graph 14. Mode 1: Notch Depth vs Clock Frequency**

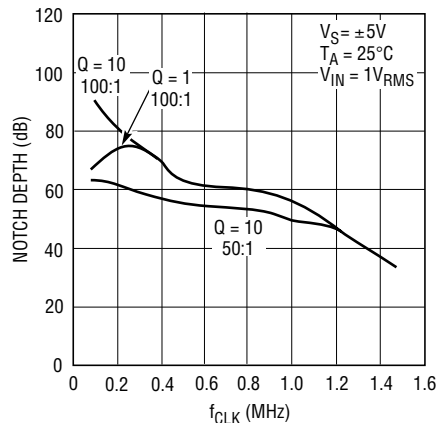

1059 G14

**Graph 15. Mode 3: Deviation of ( $f_{CLK}/f_0$ ) with Respect to Q = 10 Measurement**

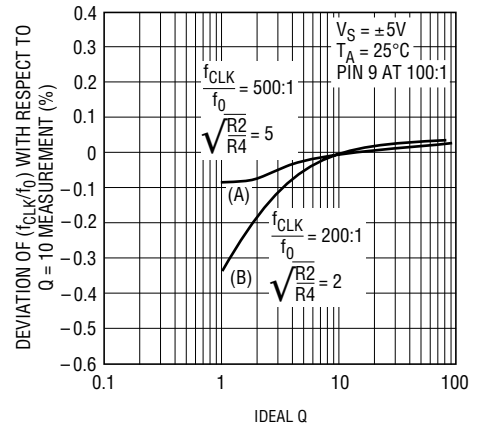

1059 G15

**Graph 16. Mode 3: Q Error vs Clock Frequency**

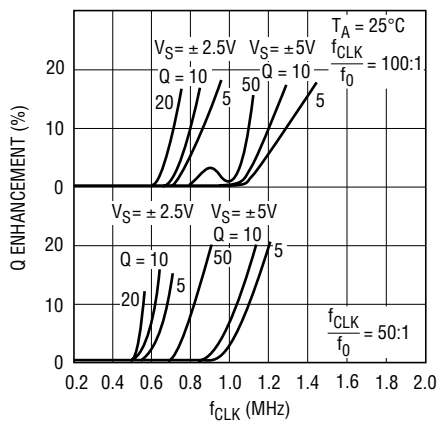

1059 G16

**Graph 17. Mode 3 (R2 = R4): Q Error vs Clock Frequency**

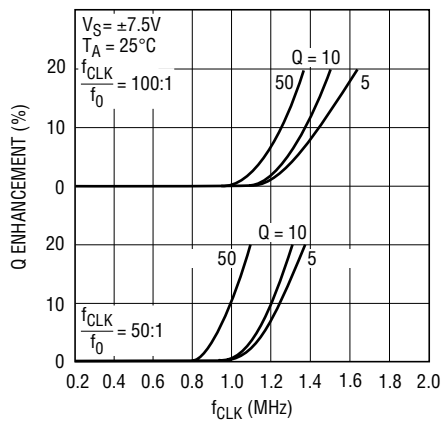

1059 G17

**Graph 18. Mode 3 (R2 = R4): Measured Q vs  $f_{CLK}$  and Temperature**

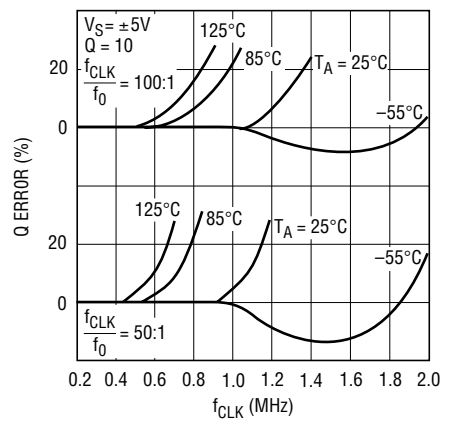

1059 G18

1059fd

**TYPICAL PERFORMANCE CHARACTERISTICS**

**Graph 19. Mode 3 (R2 = R4):  
(f<sub>CLK</sub>/f<sub>0</sub>) vs f<sub>CLK</sub> and Q**

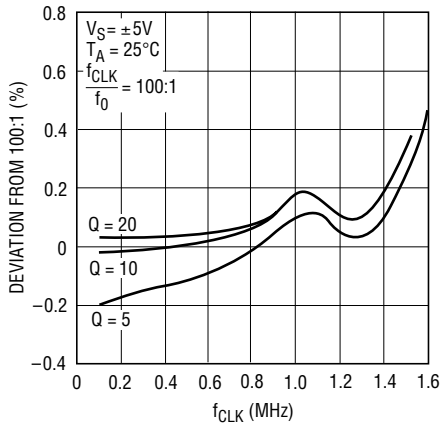

1059 G19

**Graph 20. Mode 3 (R2 = R4):  
(f<sub>CLK</sub>/f<sub>0</sub>) vs f<sub>CLK</sub> and Q**

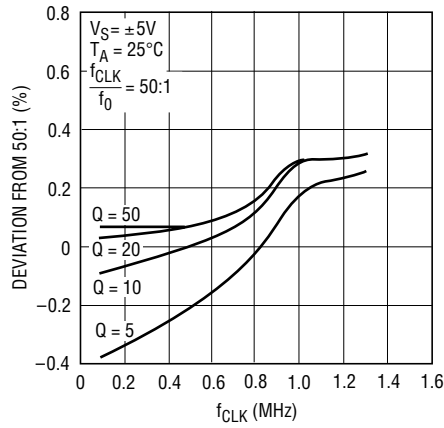

1059 G20

**Graph 21. Mode 3 (R2 = R4):  
(f<sub>CLK</sub>/f<sub>0</sub>) vs f<sub>CLK</sub> and Temperature**

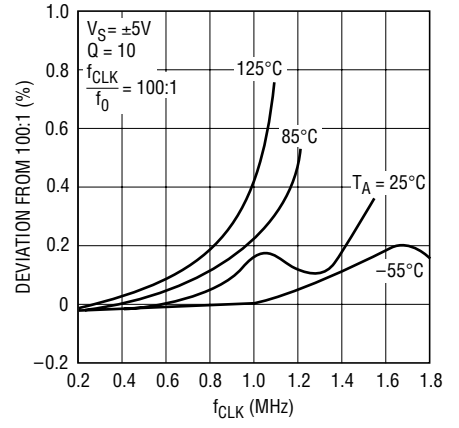

1059 G21

**Graph 22. Mode 3 (R2 = R4):  
(f<sub>CLK</sub>/f<sub>0</sub>) vs f<sub>CLK</sub> and Temperature**

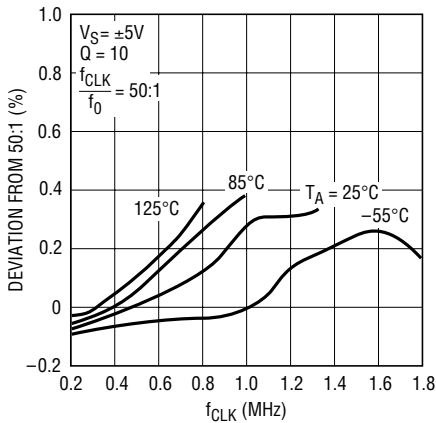

1059 G22

**Graph 23. Mode 3 (R2 = R4):  
(f<sub>CLK</sub>/f<sub>0</sub>) vs f<sub>CLK</sub> and Temperature**

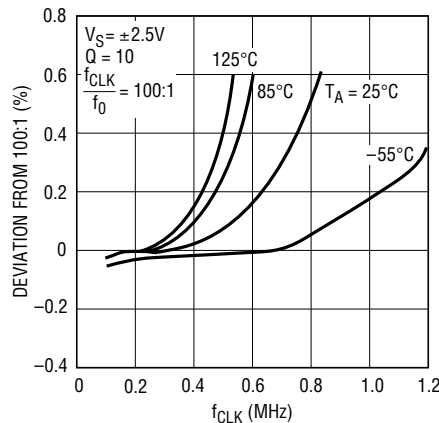

1059 G23

**Graph 24. Mode 3 (R2 = R4):  
(f<sub>CLK</sub>/f<sub>0</sub>) vs f<sub>CLK</sub> and Temperature**

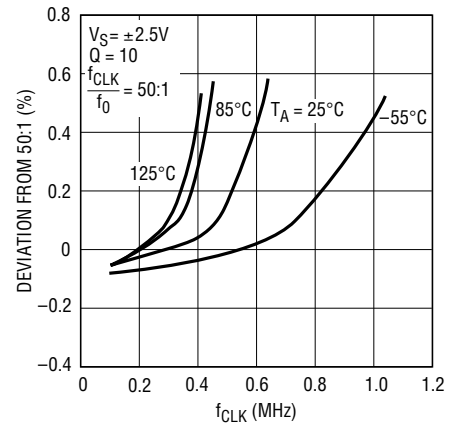

1059 G24

**Graph 25. Mode 1c (R5 = 0),  
Mode 2 (R2 = R4): Q Error vs  
Clock Frequency**

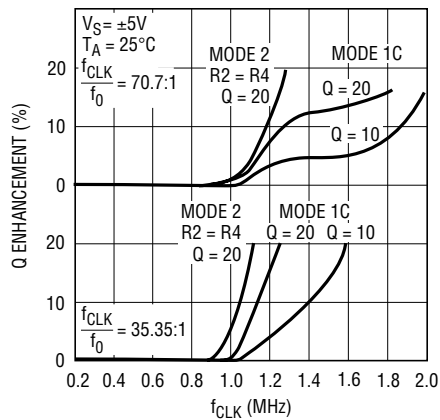

1059 G25

**Graph 26. Supply Current  
vs Supply Voltage**

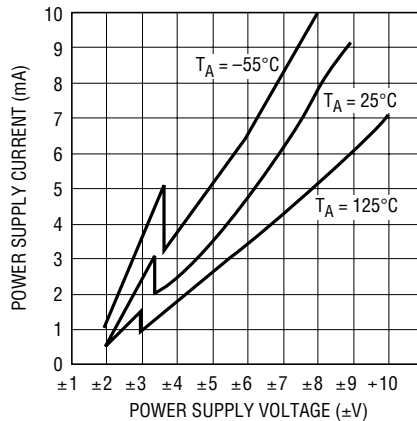

1059 G26

1059fd

## BLOCK DIAGRAM

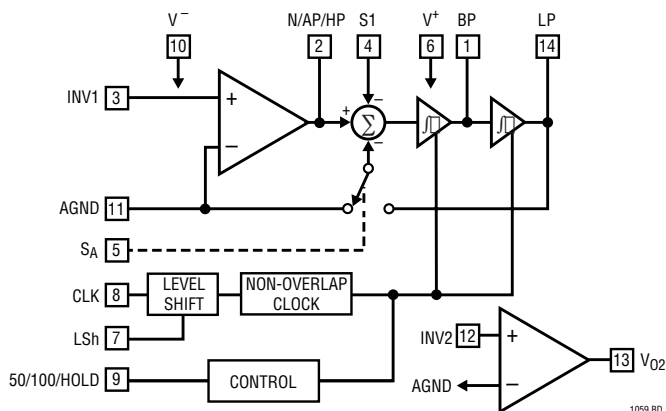

## APPLICATIONS INFORMATION

The LTC1059 is compatible with the LTC1060. All the LTC1059 pins are functionally equivalent to the LTC1060 pins bearing the same title. For a detailed pin description and definition of various modes of operation refer to the LTC1060 data sheet. The LTC1059 is typically “faster” than the LTC1060 especially under single 5V (or ±2.5V) supply

operation. This becomes apparent through the Typical Performance Characteristics of the part. All the graphs shown in this data sheet have been drawn under the same test conditions as in the LTC1060 data sheet; they are also numbered in the same order. For complete discussion of the filter characteristics see the LTC1060 data sheet.

## PACKAGE DESCRIPTION

**J Package**  
**14-Lead CERDIP (Narrow .300 Inch, Hermetic)**  
 (Reference LTC DWG # 05-08-1110)

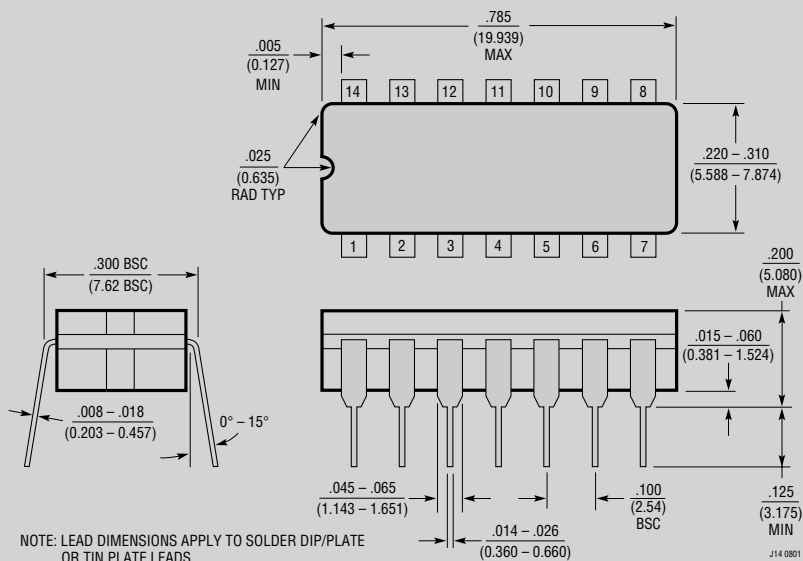

NOTE: LEAD DIMENSIONS APPLY TO SOLDER DIP/PLATE OR TIN PLATE LEADS

**OBsolete PACKAGE**

# PACKAGE DESCRIPTION

## N Package 14-Lead PDIP (Narrow .300 Inch) (Reference LTC DWG # 05-08-1510)

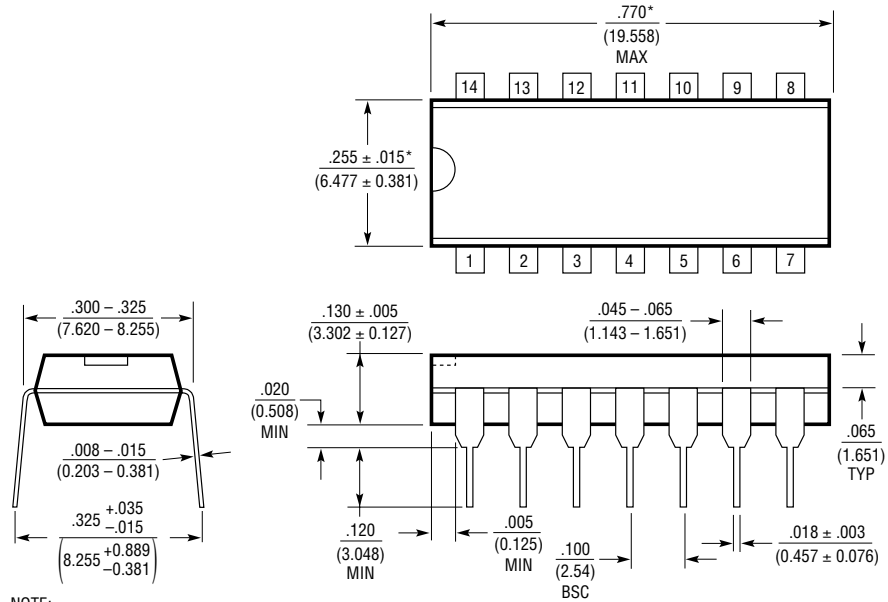

NOTE:  
1. DIMENSIONS ARE  $\frac{\text{INCHES}}{\text{MILLIMETERS}}$   
\*THESE DIMENSIONS DO NOT INCLUDE MOLD FLASH OR PROTRUSIONS.  
MOLD FLASH OR PROTRUSIONS SHALL NOT EXCEED .010 INCH (0.254mm)

N14 1002

## S Package 14-Lead Plastic Small Outline (Narrow .150 Inch) (Reference LTC DWG # 05-08-1610)

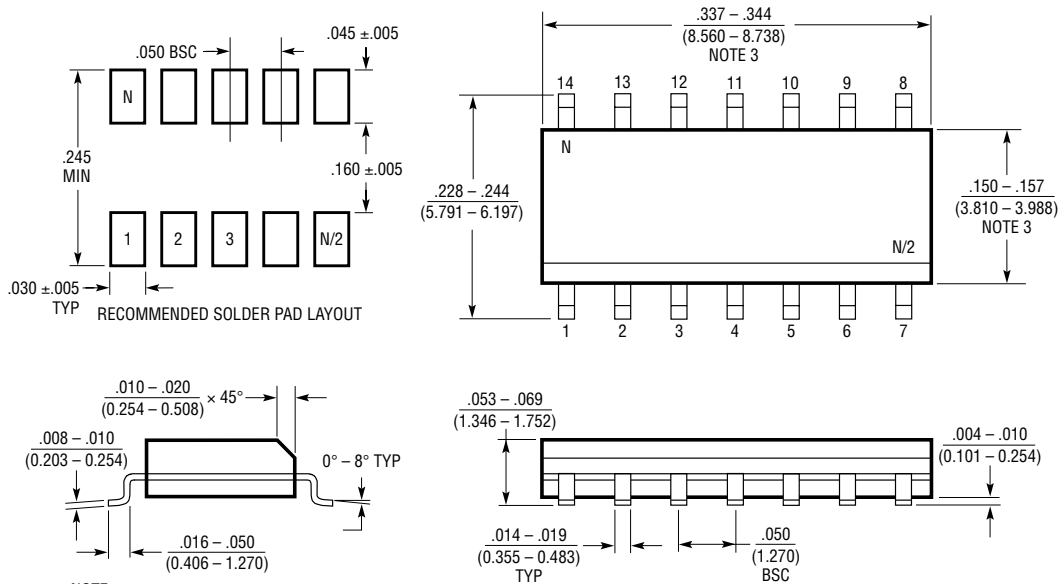

NOTE:  
1. DIMENSIONS IN  $\frac{\text{INCHES}}{\text{MILLIMETERS}}$   
2. DRAWING NOT TO SCALE  
3. THESE DIMENSIONS DO NOT INCLUDE MOLD FLASH OR PROTRUSIONS.  
MOLD FLASH OR PROTRUSIONS SHALL NOT EXCEED .006" (0.15mm)

S14 0502