

OBSOLETE:
 FOR INFORMATION PURPOSES ONLY
 Contact Linear Technology for Potential Replacement

FEATURES

- Single Chip Provides DCE RS232 or RS422/AppleTalk DCE Port
- Operates from a Single 5V Supply
- Charge Pump Uses 0.1µF Capacitors
- Output Common-Mode Voltage Range Exceeds Power Supply Rails for All Drivers
- Driver Outputs Are High Impedance with Power Off
- Pin Selectable RS232/RS422 Receiver
- Thermal Shutdown Protection
- Drivers Are Short-Circuit Protected

APPLICATIONS

- Dual-Mode RS232/RS422 Peripherals
- AppleTalk Peripherals
- Single 5V Systems

DESCRIPTION

The LTC[®]1318 is a single 5V, RS232/RS422 transceiver for connection to the DCE, or peripheral side of an interface link. It includes an on-board charge pump to generate a ±8V supply which allows true RS232 output swings. The charge pump requires only four external 0.1µF capacitors. The LTC1318 includes two RS232 drivers, a differential RS422 driver, a dedicated RS232 receiver, and a pin selectable RS232/RS422 receiver which can receive either single-ended or differential signals.

The LTC1318 features driver outputs which can be taken to common-mode voltages outside the power supply rails without damage. Additionally, the driver outputs assume a high impedance state when the power is shut off, preventing externally applied signals from feeding back into the power supplies. The RS232 devices will operate at speeds up to 100kbaud. The RS422 devices will operate up to 2Mbaud.

The LTC1318 is available in a 24-lead SO Wide package.

LT, LTC and LT are registered trademarks of Linear Technology Corporation.
 AppleTalk and LocalTalk are registered trademarks of Apple Computer, Inc.

TYPICAL APPLICATION

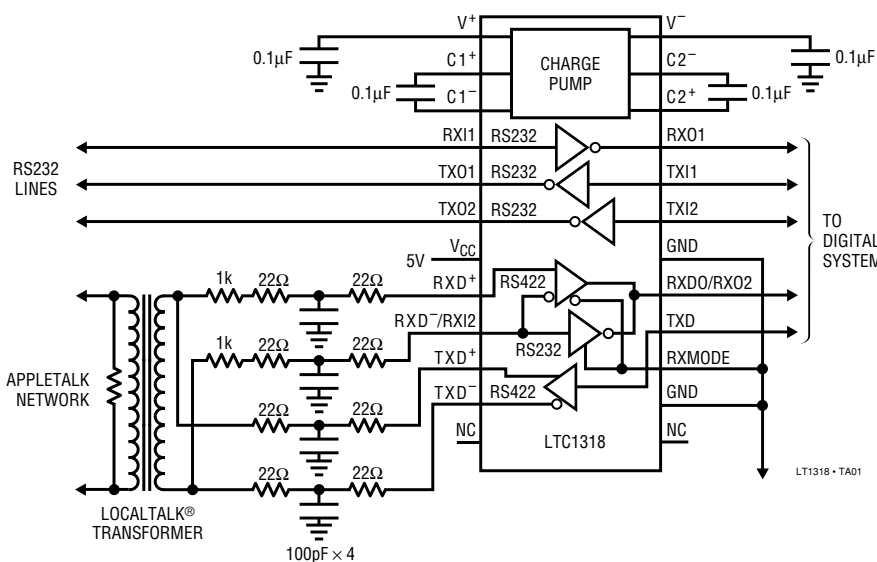

Driver Output Waveforms

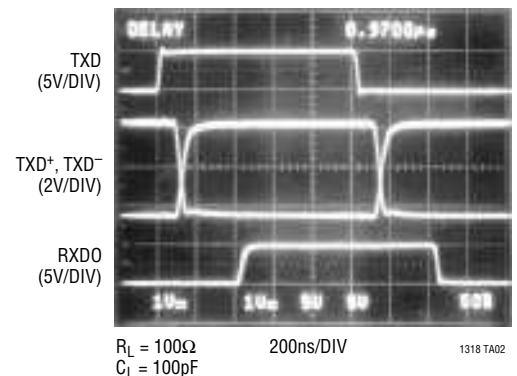

ABSOLUTE MAXIMUM RATINGS

(Note 1)

Supply Voltage:

V _{CC}	7V
V ⁺	13.2V
V ⁻	-13.2V

Input Voltage:

All Drivers	-0.3 to (V _{CC} + 0.3V)
All Receivers	-25V to 25V
RXMODE Pin	-0.3V to (V _{CC} + 0.3V)

Output Voltage:

RS232 Drivers	(V ⁺ - 30V) to (V ⁻ + 30V)
RS422 Drivers	±15V
All Receivers	-0.3V to (V _{CC} + 0.3V)

Short-Circuit Duration:

V ⁺ or V ⁻ to GND	30 sec
Driver or Receiver Outputs	Indefinite

Operating Temperature Range

Lead Temperature (Soldering, 10 sec).....

PACKAGE/ORDER INFORMATION

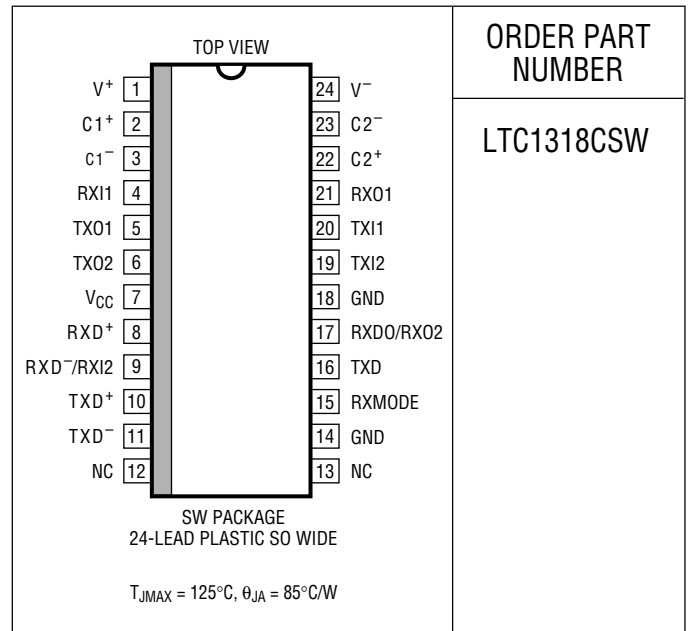

Consult factory for Industrial and Military grade parts

ELECTRICAL CHARACTERISTICS

V_S = 5V ±5%, C1 = C2 = 0.1µF, T_A = 0°C to 70°C, unless otherwise specified. (Notes 2, 3)

SYMBOL	PARAMETER	CONDITIONS	MIN	TYP	MAX	UNITS	
Supplies							
I _{CC}	Supply Current	No Load	●	9	30	mA	
V ⁺	Positive Charge Pump Output Voltage	I _{OUT} = 0mA	●	7.8	8.8	V	
		I _{OUT} = 10mA, V _{CC} = 5V	●	6.8	7.4	V	
V ⁻	Negative Charge Pump Output Voltage	I _{OUT} = 0mA	●	-7.3	-8.6	V	
		I _{OUT} = -5mA, V _{CC} = 5V	●	-6.3	-7.3	V	
Differential Driver							
V _{OD}	Differential Driver Output Voltage	No Load (Figure 1)	●	±4		V	
		R _L = 100Ω (Figure 1)	●	±2		V	
DV _{OD}	Change in Magnitude of Differential Output Voltage	R _L = 100Ω (Figure 1)	●		0.2	V	
V _{OC}	Common-Mode Output Voltage	R _L = 100Ω (Figure 1)	●		3	V	
I _{DSS}	Short-Circuit Output Current	-1V < V _{CMR} < 7V	●	35	200	mA	
V _{IL}	Input Low Voltage		●		0.8	V	
V _{IH}	Input High Voltage		●	2.0		V	
Single-Ended Driver							
V _O	Output Voltage Swing	R _L = 3k	●	±5	7.3/-6.5	V	
I _{OSS}	Short-Circuit Output Current	V _{OUT} = 0V	●	±5	17	mA	
V _{IL}	Input Low Voltage		●		0.8	V	
V _{IH}	Input High Voltage		●	2		V	
SR	Output Slew Rate	R _L = 3k, C _L = 51pF	●	4	20	30	V/µS

ELECTRICAL CHARACTERISTICS

$V_S = 5V \pm 5\%$, $C1 = C2 = 0.1\mu F$, $T_A = 0^\circ C$ to $70^\circ C$, unless otherwise specified. (Notes 2, 3)

SYMBOL	PARAMETER	CONDITIONS		MIN	TYP	MAX	UNITS
Differential Receiver							
V_{TH}	Differential Receiver Threshold		●	-0.2		0.2	V
CMR	Common-Mode Input Range		●	-7		7	V
	Hysteresis	$V_{CM} = 0V$	●		30		mV
R_{IN}	Input Resistance	$T_A = 25^\circ C$		3	5	7	$k\Omega$
V_{OL}	Output Low Voltage	$I_{OUT} = -1.6mA$				0.4	V
V_{OH}	Output High Voltage	$I_{OUT} = 160\mu A$, $V_{CC} = 5V$	●	3.5			V
I_{OSS}	Short-Circuit Output Current	$V_O = GND$ or V_{CC}	●	± 7		± 85	mA
Single-Ended Receiver							
V_L	Input Voltage Low Threshold		●	0.8	1.4		V
V_{IH}	Input Voltage High Threshold		●		1.8	2.4	V
	Hysteresis		●	0.1	0.4	1.0	V
R_{IN}	Input Resistance	$T_A = 25^\circ C$		3	5	7	$k\Omega$
V_{OL}	Output Low Voltage	$I_{OUT} = -4mA$	●		0.2	0.4	V
V_{OH}	Output High Voltage	$I_{OUT} = 4mA$, $V_{CC} = 5V$	●	3.5	4.8		-V
I_{OSS}	Short-Circuit Output Current	$V_O = GND$ or V_{CC}	●	± 7		± 85	mA
V_{ILRXM}	RXMODE Input Low Voltage		●	0.8	1.6		V
V_{IHRXM}	RXMODE Input High Voltage		●		1.6	2.0	V
I_{INRXM}	RXMODE Input Current	$V_{IN} = 0V$ or V_{CC}	●			± 2	μA
Switching Characteristics							
$t_{PLH,HL}$	Differential Driver Propagation Delay	$R_L = 100\Omega$, $C_L = 100pF$ (Figures 2,3)	●		35	100	ns
t_{SKEW}	Differential Driver Output to Output	$R_L = 100\Omega$, $C_L = 100pF$ (Figures 2,3)	●		5	35	ns
$t_{R,F}$	Differential Driver Rise, Fall Time	$R_L = 100\Omega$, $C_L = 100pF$ (Figures 2,3)	●		15	50	ns
$t_{PLH,HL}$	Differential Receiver Propagation Delay	$C_L = 15pF$, (Figures 4)	●		110	200	ns
t_{SEL}	Receiver Mode Switching Time		●		25	100	ns

The ● denotes specifications which apply over the full operating temperature range.

Note 1: Absolute maximum ratings are those values beyond which the life of the device may be impaired.

Note 2: All currents into device pins are negative, all currents out of device pins are positive. All voltages are referenced to ground unless otherwise specified.

Note 3: All typicals are given at $V_{CC} = 5V$, $T_A = 25^\circ C$.

TYPICAL PERFORMANCE CHARACTERISTICS

Supply Current vs Temperature

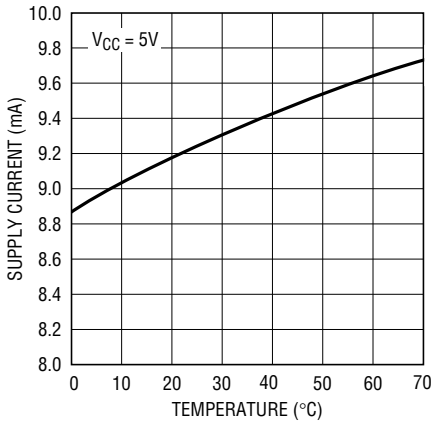

1318 G01

Charge Pump Output Voltage vs Load Current

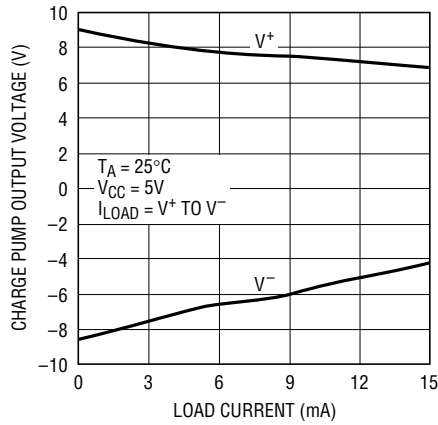

1318 G02

TTL Input Threshold vs Temperature

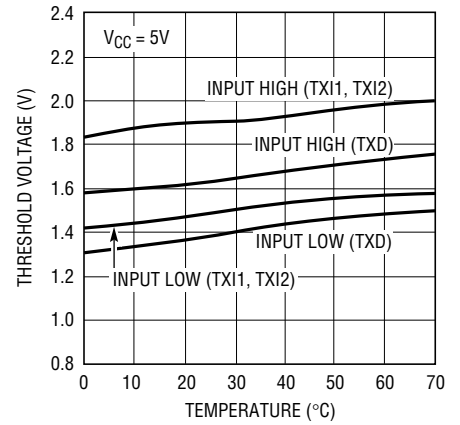

1318 G03

RS422 Driver Differential Output Swing vs Load Current

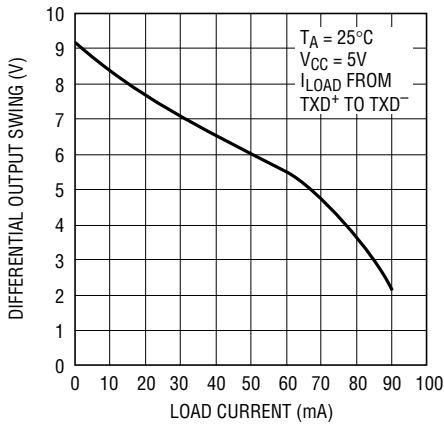

1318 G04

RS422 Driver Single-Ended Output Swing vs Load Current

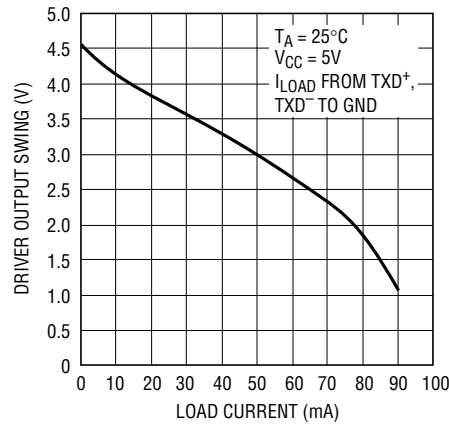

1318 G05

RS422 Driver Short-Circuit Current vs Temperature

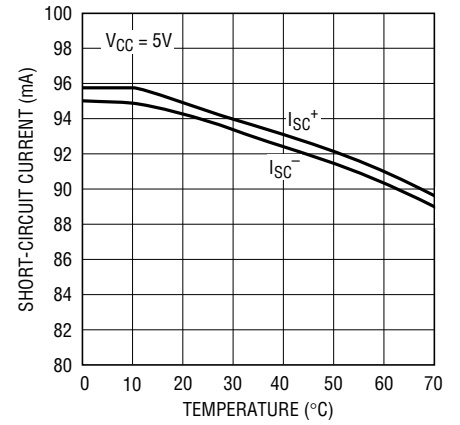

1318 G06

RS232 Driver Slew Rate vs Load Capacitance

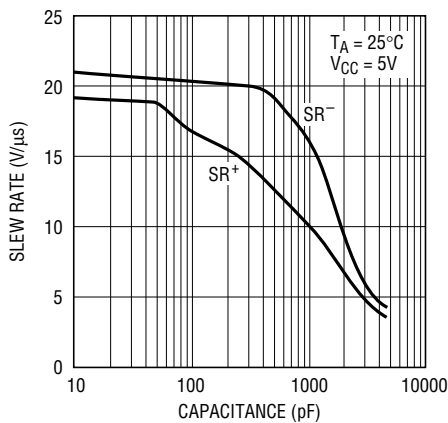

1318 G07

RS232 Driver Output Swing vs Resistive Load

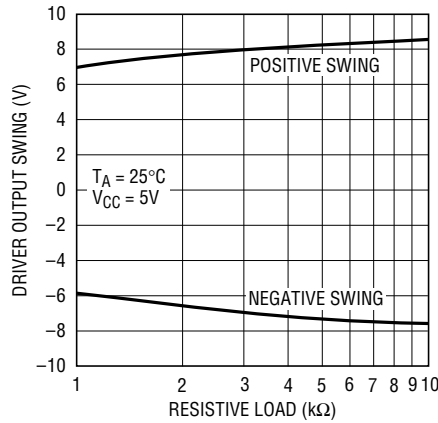

1318 G08

RS232 Driver Short-Circuit Current vs Temperature

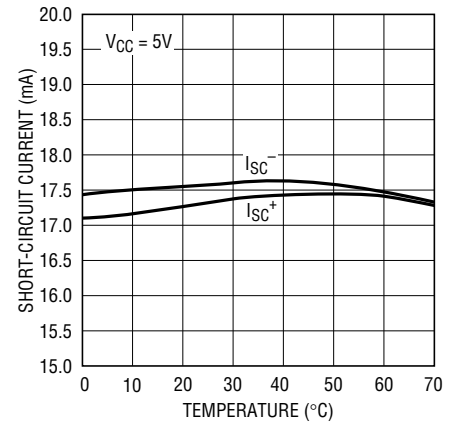

1318 G09

TYPICAL PERFORMANCE CHARACTERISTICS

RS422 Receiver Differential Threshold vs Temperature

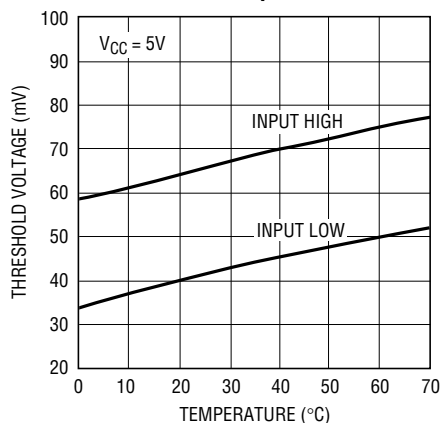

1318 G10

RS232 Receiver Input Threshold vs Temperature

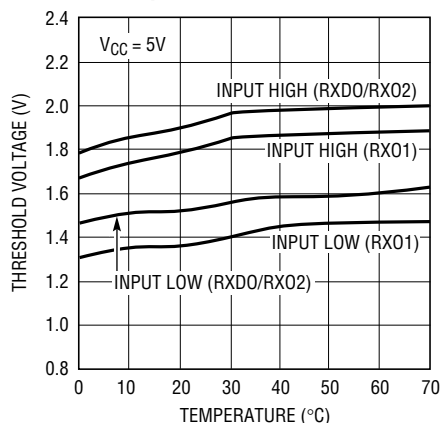

1318 G11

TTL Output Short-Circuit Current vs Temperature

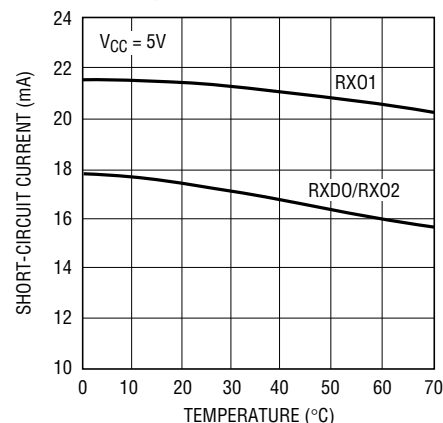

1318 G12

PIN FUNCTIONS

V⁺ (Pin 1): Charge Pump Positive Output. This pin requires a 0.1μF capacitor to ground. Under normal operation this pin maintains a voltage of about 8.8V above ground. An external load can be connected between this pin and ground or V⁻.

C1⁺, C1⁻ (Pins 2, 3): C1 Inputs. Connect a 0.1μF capacitor between C1⁺ and C1⁻.

RX11 (Pin 4): First RS232 Single-Ended Receiver Input. This is an inverting receiver.

TX01, TX02 (Pins 5,6): RS232 Single-Ended Driver Outputs.

V_{CC} (Pin 7): Positive Supply Input. Apply $4.75V \leq V_{CC} \leq 5.25V$ to this pin. A 0.1μF bypass capacitor is required.

RXD⁺ (Pin 8): When RXMODE (pin 15) is low, this pin acts as the differential RS422 receiver positive input. When RXMODE is high, this pin is disabled.

RXD⁻/RXI2 (Pin 9): When RXMODE (pin 15) is low, this pin acts as the differential RS422 receiver negative input. When RXMODE is high, this pin acts as the second RS232 receiver input. The receiver is inverting in RS232 mode.

TXD⁺ (Pin 10): Differential RS422 Driver Noninverting Output.

TXD⁻ (Pin 11): Differential RS422 Driver Inverting Output.

NC (Pins 12,13): No Internal Connection.

GND (Pins 14, 18): Power Supply Ground. Connect both pins to each other and to the ground.

RXMODE (Pin 15): This pin controls the state of the differential/single-ended receiver. When RXMODE is low, the receiver is in differential mode and will receive RS422 compatible signals at RXD⁺ and RXD⁻/RXI2 (pins 8 and 9). When RXMODE goes high, the receiver enters single-ended mode and will receive RS232 compatible signals at RXD⁻/RXI2. RXD⁺ is disabled in single-ended mode. Both modes use the RXD0/RX02 pin (pin 17) as their output.

TXD (Pin 16): Differential RS422 Driver Input (TTL Compatible).

RXD0/RX02 (Pin 17): This is the output of the configurable differential/single-ended receiver.

TXI1, TXI2 (Pins 20, 19): RS232 Driver Inputs (TTL Compatible). Both are inverting inputs.

RX01 (Pin 21): First RS232 Receiver Outputs (TTL compatible).

PIN FUNCTIONS

C2⁺, C2⁻ (Pins 22, 23): C2 inputs. Connect a 0.1μF capacitor between C2⁺ and C2⁻.

V⁻ (Pin 24): Charge Pump Negative Output. This pin requires a 0.1μF capacitor to ground. Under normal operation,

this pin maintains a voltage of about 8.6V below ground. An external load can be connected between this pin and ground or V⁺.

TEST CIRCUITS

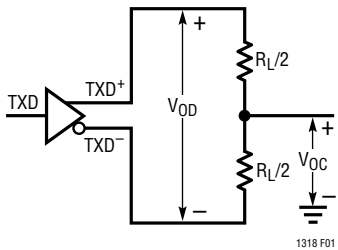

Figure 1.

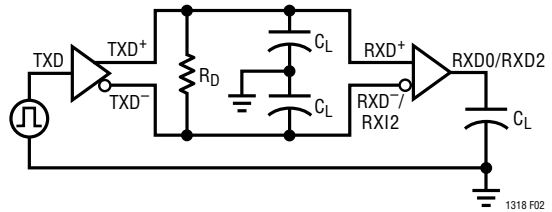

Figure 2.

SWITCHING WAVEFORMS

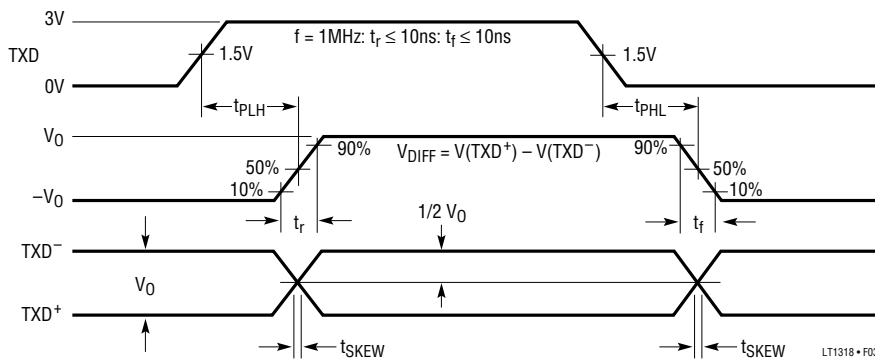

Figure 3. Differential Driver

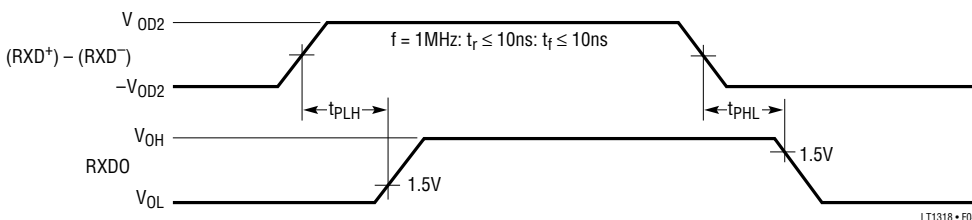

Figure 4. Differential Receiver

APPLICATION INFORMATION

Interface Standards

The LTC1318 provides compatibility with both RS232 and RS422/AppleTalk/LocalTalk standards in a single chip, enabling a system to communicate using either protocol as necessary. The LTC1318 provides two RS232 single-ended drivers, one RS422 differential driver, and two receivers. One of the receivers is a dedicated RS232 single-ended receiver, while the other can be configured for RS232 (single-ended) or RS422 (differential) operation by controlling the logic state of the select pin. All single-ended drivers and receivers meet the RS232C specification for output swing, load driving capacity and input range, and can additionally transmit and receive signals as high as 100kbaud. The differential driver and receiver can interface to both RS422 and AppleTalk networks, and can transmit and receive signals at rates exceeding 2Mbaud.

Fault Protection

The LTC1318 incorporates many protection features to make it as “bustproof” as possible. All driver outputs and receiver inputs are protected against ESD strikes to $\pm 6\text{kV}$, eliminating the need for external protection devices in most applications. All driver outputs can be taken outside the power supply rails without damage and will not allow current to be forced back into the supplies, preventing the output fault from affecting other logic circuits using the same power supply. Additionally, the driver outputs enter a high impedance state when the power is removed, preventing the system from loading the data lines when it is shut off. All driver and receiver outputs are protected against short circuits to ground or to the supply rails.

Charge Pump Power Supply

The LTC1318 includes an on-board charge pump to generate the voltages necessary for true RS232 compatible output swing. This charge pump requires just four external $0.1\mu\text{F}$ capacitors to operate; two flying caps connected

to the $C1^+/C1^-$ and $C2^+/C2^-$ pins, and two hold caps, one from V^+ to ground and one from V^- to ground. The charge pump has enough extra capacity to drive light external loads and still meet RS232 specifications; it will support a 10mA load from V^+ to ground or a 5mA from V^+ to V^- (Figure 5).

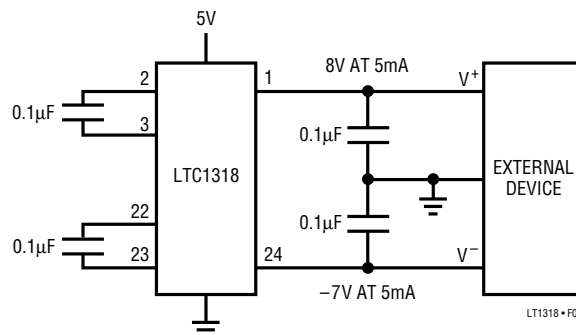

Figure 5.

Configurable RS422/RS232 Receiver

There are two line receivers in the LTC1318. One is a dedicated RS232 receiver; the other can receive both single-ended RS232 signals and differential RS422 signals. This second receiver has two inputs: RXD^+ (pin 8) and RXD^- (pin 9) to accept differential signals. The RXD^+ input is disabled in single-ended mode. The receiver mode is set by the $RXMODE$ (pin 15). A low level on $RXMODE$ configures the receiver in differential mode; it accepts input at RXD^+ and RXD^- and outputs the data at $RXDO$ (pin 17). A high level at $RXMODE$ forces the receiver into single-ended mode; RXD^+ is disabled, pin 9 switches identity from RXD^- to $RXI2$, and pin 17 switches from $RXDO$ to $RXO2$, the single-ended data output. In this mode the receiver accepts RS232 signals at $RXI2$ and outputs the data through $RXO2$. The receiver becomes inverting in single-ended mode. This receiver can switch between its two modes within 100ns, allowing the system to sense the input signal and configure itself accordingly.

PACKAGE DESCRIPTION Dimensions in inches (millimeters) unless otherwise noted.

S PACKAGE
24-Lead Plastic SOL

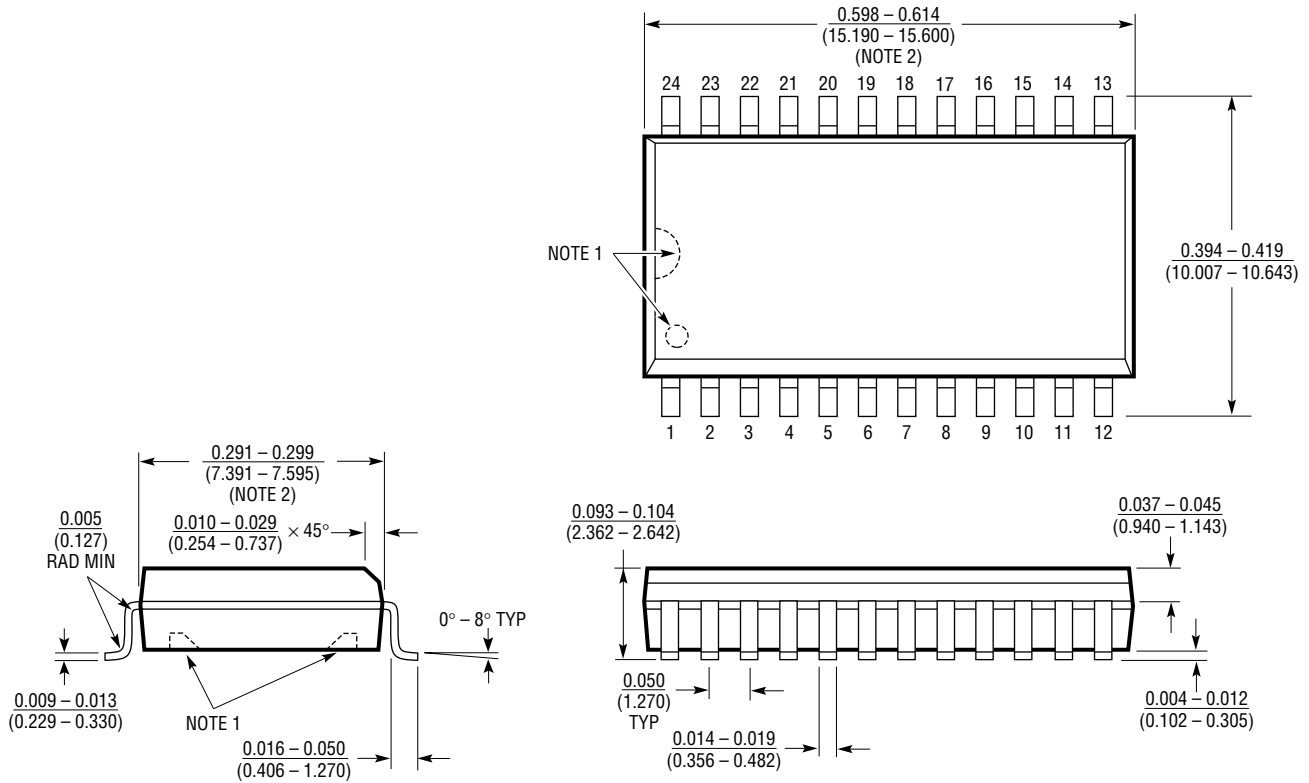

- NOTE:
1. PIN 1 IDENT, NOTCH ON TOP AND CAVITIES ON THE BOTTOM OF PACKAGES ARE THE MANUFACTURING OPTIONS. THE PART MAY BE SUPPLIED WITH OR WITHOUT ANY OF THE OPTIONS.
 2. THESE DIMENSIONS DO NOT INCLUDE MOLD FLASH OR PROTRUSIONS. MOLD FLASH OR PROTRUSIONS SHALL NOT EXCEED 0.006 INCH (0.15mm).

SOL24 0392