

FDY6342L

Integrated Load Switch

Features

- Max $r_{DS(on)}$ = 0.5 Ω at $V_{GS} = 4.5$ V, $I_D = -0.83$ A
- Max $r_{DS(on)}$ = 0.7 Ω at $V_{GS} = 2.5$ V, $I_D = -0.70$ A
- Max $r_{DS(on)}$ = 1.2 Ω at $V_{GS} = 1.8$ V, $I_D = -0.43$ A
- Max $r_{DS(on)}$ = 1.8 Ω at $V_{GS} = 1.5$ V, $I_D = -0.36$ A
- Control MOSFET (Q1) includes Zener protection for ESD ruggedness (>4 kV Human body model)
- High performance trench technology for extremely low $r_{DS(on)}$
- Compact industry standard SC89-6 surface mount package
- RoHS Compliant



General Description

This device is particularly suited for compact power management in portable electronic equipment where 2.5 V to 8 V input and 0.83 A output current capability are needed. This load switch integrates a small N-Channel power MOSFET (Q1) that drives a large P-Channel power MOSFET (Q2) in one tiny SC89-6 package.

Applications

- Power management
- Load switch

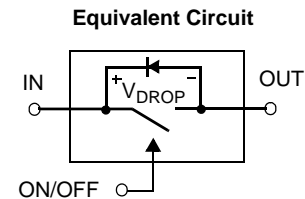
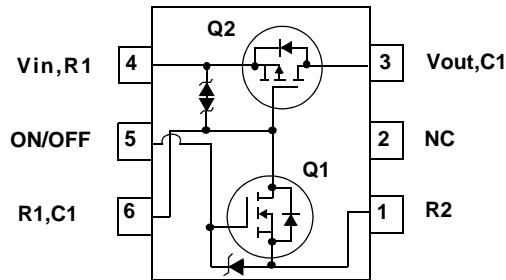
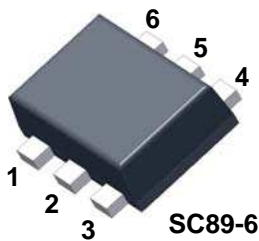

See Application Circuit

MOSFET Maximum Ratings $T_A = 25$ °C unless otherwise noted

Symbol	Parameter	Ratings	Units
V_{IN}	Gate to Source Voltage (Q2)	± 8	V
$V_{ON/OFF}$	Gate to Source Voltage (Q1)	-0.5 to 8	V
I_{Load}	Load Current -Continuous	(Note 2)	-0.83
	-Pulsed	(Note 2)	-1.0
P_D	Power Dissipation	(Note 1a)	0.625
	Power Dissipation	(Note 1b)	0.446
T_J, T_{STG}	Operating and Storage Junction Temperature Range	-55 to +150	°C

Thermal Characteristics

$R_{\theta JA}$	Thermal Resistance, Junction to Ambient	(Note 1a)	200	°C/W
$R_{\theta JA}$	Thermal Resistance, Junction to Ambient	(Note 1b)	280	

Package Marking and Ordering Information

Device Marking	Device	Package	Reel Size	Tape Width	Quantity
H	FDY6342L	SC89-6	7"	8 mm	3000 units

Electrical Characteristics $T_J = 25\text{ }^\circ\text{C}$ unless otherwise noted

Symbol	Parameter	Test Conditions	Min	Typ	Max	Units
--------	-----------	-----------------	-----	-----	-----	-------

Off Characteristics

BV_{IN}	V_{IN} Breakdown Voltage	$I_D = -250\text{ }\mu\text{A}$, $V_{ON/OFF} = 0\text{ V}$	8			V
I_{Load}	Zero Gate Voltage Drain Current	$V_{IN} = -6.4\text{ V}$, $V_{ON/OFF} = 0\text{ V}$			-1	μA
I_{FL}	Leakage Current, Forward	$V_{IN} = 8\text{ V}$, $V_{ON/OFF} = 0\text{ V}$			10	μA
I_{RL}	Leakage Current, Reverse	$V_{IN} = -8\text{ V}$, $V_{ON/OFF} = 0\text{ V}$			-10	μA

On Characteristics (note 2)

$V_{ON/OFF(th)}$	Gate Threshold Voltage	$V_{IN} = V_{ON/OFF}$, $I_D = -250\text{ }\mu\text{A}$	0.65	0.85	1.5	V
$r_{DS(on)}$	Static Drain to Source On Resistance (Q_2)	$V_{IN} = 4.5\text{ V}$, $I_D = -0.83\text{ A}$		0.28	0.5	Ω
		$V_{IN} = 2.5\text{ V}$, $I_D = -0.70\text{ A}$		0.35	0.7	
		$V_{IN} = 1.8\text{ V}$, $I_D = -0.43\text{ A}$		0.45	1.2	
		$V_{IN} = 1.5\text{ V}$, $I_D = -0.36\text{ A}$		0.57	1.8	
		$V_{IN} = 4.5\text{ V}$, $I_D = 0.4\text{ A}$		2.9	4.0	
	Static Drain to Source On Resistance (Q_1)	$V_{IN} = 2.7\text{ V}$, $I_D = 0.2\text{ A}$		3.5	5.0	Ω

Drain-Source Diode Characteristics

I_S	Maximum Continuous Drain to Source Diode Forward Current				-0.25	V
V_{SD}	Source to Drain Diode Forward Voltage	$V_{ON/OFF} = 0\text{ V}$, $I_S = -0.25\text{ A}$ (Note 2)		-0.8	-1.2	V

NOTES:

- $R_{\theta JA}$ is determined with the device mounted on a 1 in² pad 2 oz copper pad on a 1.5 x 1.5 in. board of FR-4 material. $R_{\theta JC}$ is guaranteed by design while $R_{\theta JA}$ is determined by the user's board design.



a) 200 °C/W when mounted on a 1 in² pad of 2 oz copper.

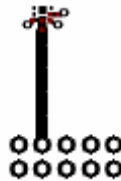

b) 280 °C/W when mounted on a minimum pad of 2 oz copper.

- Pulse Test: Pulse Width < 300 μs , Duty cycle < 2.0%.

FDY6342L Load Switch Application circuit

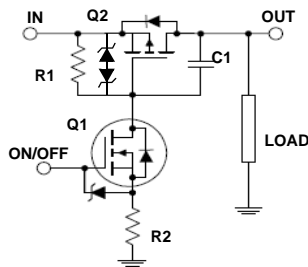

External Component Recommendation:

For additional in-rush current control, R2 and C1 can be added. For more information, see application note AN1030

Typical Characteristics $T_J = 25\text{ }^\circ\text{C}$ unless otherwise noted

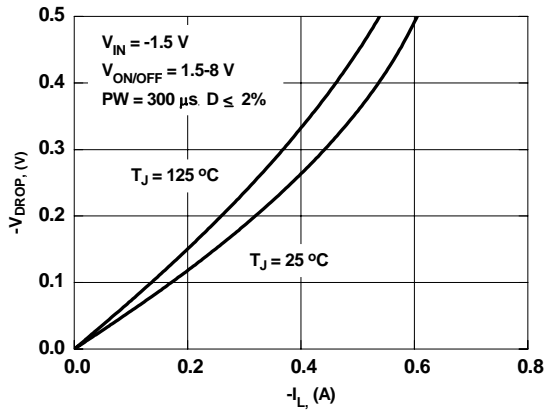

Figure 1. Conduction Voltage Drop Variation with Load Current

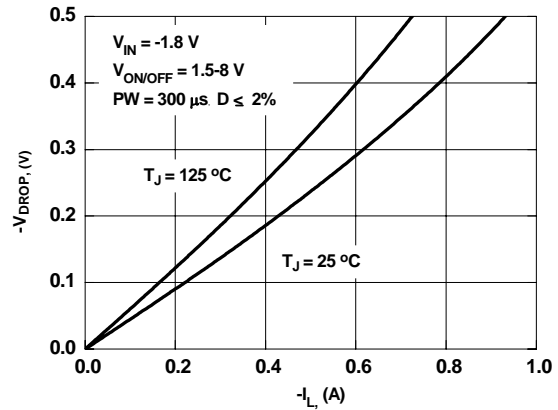

Figure 2. Conduction Voltage Drop Variation with Load Current

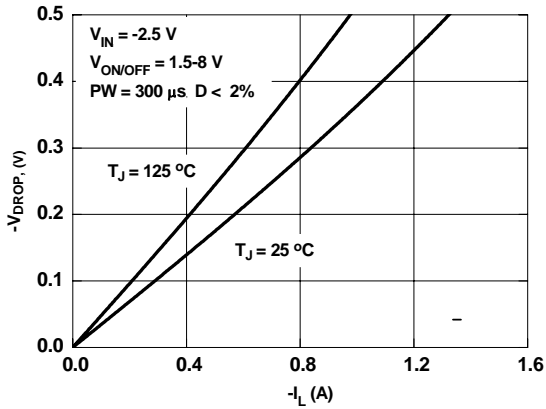

Figure 3. Conduction Voltage Drop Variation with Load Current

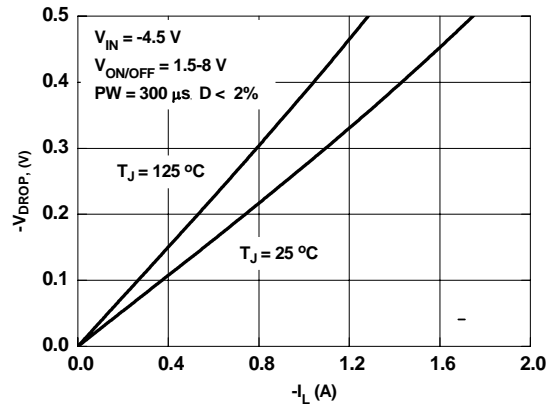

Figure 4. Conduction Voltage Drop Variation with Load Current

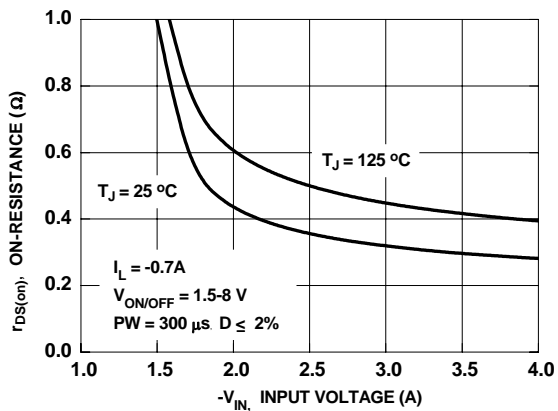

Figure 5. On-Resistance Variaton with Input Current

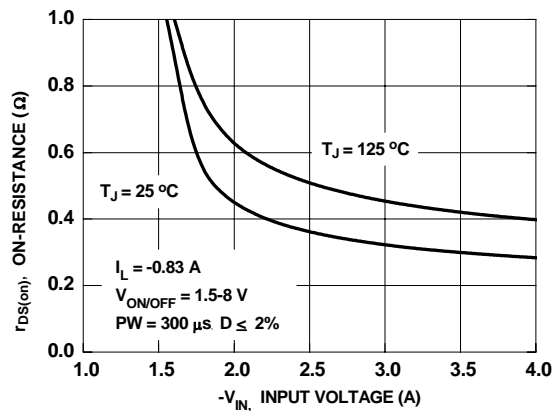
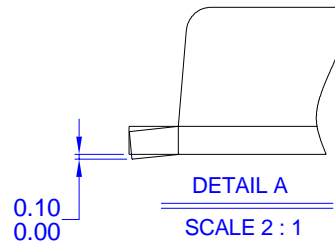
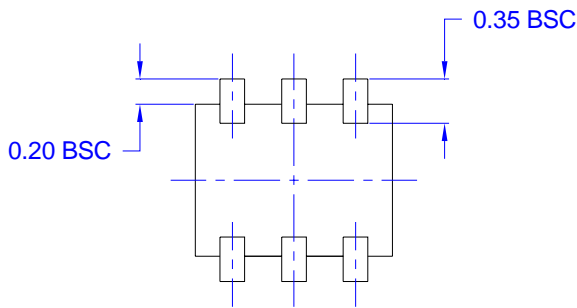
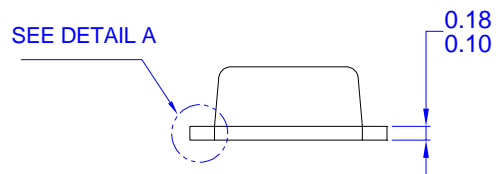
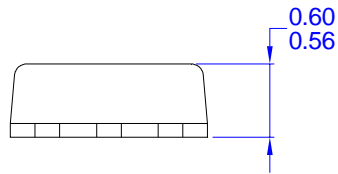
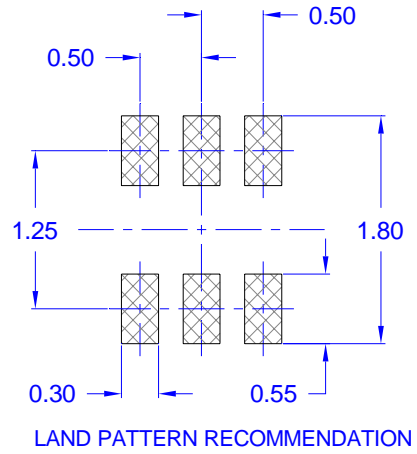
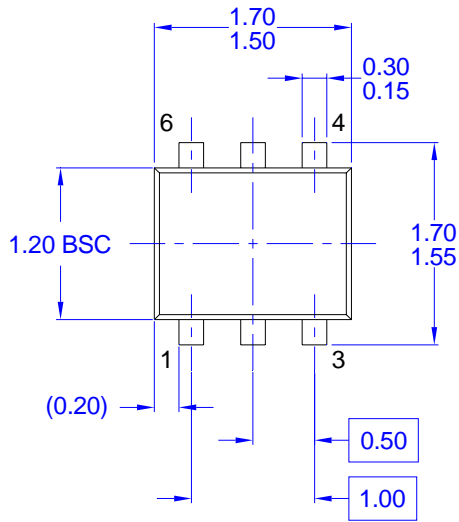

Figure 6. On-Resistance Variaton with Input Current

Dimensional Outline and Pad Layout



- NOTES: UNLESS OTHERWISE SPECIFIED
 A) THIS PACKAGE CONFORMS TO EIAJ SC89 PACKAGING STANDARD.
 B) ALL DIMENSIONS ARE IN MILLIMETERS.
 C) DIMENSIONS ARE EXCLUSIVE OF BURRS, MOLD FLASH, AND TIE BAR EXTRUSIONS.



TRADEMARKS

The following includes registered and unregistered trademarks and service marks, owned by Fairchild Semiconductor and/or its global subsidiaries, and is not intended to be an exhaustive list of all such trademarks.

- | | | | |
|---|---|---|---|
| Build it Now™ | FRFET® | Programmable Active Droop™ | the power franchise |
| CorePLUS™ | Global Power Resource SM | QFET® | TinyBoost™ |
| CorePOWER™ | Green FPS™ | QS™ | TinyBuck™ |
| CROSSVOLT™ | Green FPS™ e-Series™ | Quiet Series™ | TinyLogic® |
| CTL™ | GTO™ | RapidConfigure™ | TINYOPTO™ |
| Current Transfer Logic™ | IntelliMAX™ |  | TinyPower™ |
| EcoSPARK® | ISOPLANAR™ | Saving our world, 1mW /W /kW at a time™ | TinyPWM™ |
| EfficientMax™ | MegaBuck™ | SmartMax™ | TinyWire™ |
| EZSWITCH™ * | MICROCOUPLER™ | SMART START™ | µSerDes™ |
|  | MicroFET™ | SPM® |  |
|  | MillerDrive™ | STEALTH™ | UHC® |
| Fairchild® | MotionMax™ | SuperFET™ | Ultra FRFET™ |
| Fairchild Semiconductor® | Motion-SPM™ | SuperSOT™-3 | UniFET™ |
| FACT Quiet Series™ | OPTOLOGIC® | SuperSOT™-6 | VCX™ |
| FACT® | OPTOPLANAR® | SuperSOT™-8 | VisualMax™ |
| FAST® |  | SupreMOS™ | XS™ |
| FastvCore™ | PDP SPM™ | SyncFET™ | |
| FlashWriter® * | Power-SPM™ |  | |
| FPST™ | PowerTrench® | The Power Franchise® | |
| F-PFS™ | PowerXS™ | | |

* EZSWITCH™ and FlashWriter® are trademarks of System General Corporation, used under license by Fairchild Semiconductor.

DISCLAIMER

FAIRCHILD SEMICONDUCTOR RESERVES THE RIGHT TO MAKE CHANGES WITHOUT FURTHER NOTICE TO ANY PRODUCTS HEREIN TO IMPROVE RELIABILITY, FUNCTION, OR DESIGN. FAIRCHILD DOES NOT ASSUME ANY LIABILITY ARISING OUT OF THE APPLICATION OR USE OF ANY PRODUCT OR CIRCUIT DESCRIBED HEREIN; NEITHER DOES IT CONVEY ANY LICENSE UNDER ITS PATENT RIGHTS, NOR THE RIGHTS OF OTHERS. THESE SPECIFICATIONS DO NOT EXPAND THE TERMS OF FAIRCHILD'S WORLDWIDE TERMS AND CONDITIONS, SPECIFICALLY THE WARRANTY THEREIN, WHICH COVERS THESE PRODUCTS.

LIFE SUPPORT POLICY

FAIRCHILD'S PRODUCTS ARE NOT AUTHORIZED FOR USE AS CRITICAL COMPONENTS IN LIFE SUPPORT DEVICES OR SYSTEMS WITHOUT THE EXPRESS WRITTEN APPROVAL OF FAIRCHILD SEMICONDUCTOR CORPORATION.

As used herein:

- Life support devices or systems are devices or systems which, (a) are intended for surgical implant into the body or (b) support or sustain life, and (c) whose failure to perform when properly used in accordance with instructions for use provided in the labeling, can be reasonably expected to result in a significant injury of the user.
- A critical component in any component of a life support, device, or system whose failure to perform can be reasonably expected to cause the failure of the life support device or system, or to affect its safety or effectiveness.

ANTI-COUNTERFEITING POLICY

Fairchild Semiconductor Corporation's Anti-Counterfeiting Policy. Fairchild's Anti-Counterfeiting Policy is also stated on our external website, www.fairchildsemi.com, under Sales Support.

Counterfeiting of semiconductor parts is a growing problem in the industry. All manufactures of semiconductor products are experiencing counterfeiting of their parts. Customers who inadvertently purchase counterfeit parts experience many problems such as loss of brand reputation, substandard performance, failed application, and increased cost of production and manufacturing delays. Fairchild is taking strong measures to protect ourselves and our customers from the proliferation of counterfeit parts. Fairchild strongly encourages customers to purchase Fairchild parts either directly from Fairchild or from Authorized Fairchild Distributors who are listed by country on our web page cited above. Products customers buy either from fairchild directly or from Authorized Fairchild Distributors are genuine parts, have full traceability, meet Fairchild's quality standards for handling and storage and provide access to Fairchild's full range of up-to-date technical and product information. Fairchild and our Authorized Distributors will stand behind all warranties and will appropriately address and warranty issues that may arise. Fairchild will not provide any warranty coverage or other assistance for parts bought from Unauthorized Sources. Fairchild is committed to combat this global problem and encourage our customers to do their part in stopping this practice by buying direct or from authorized distributors.

PRODUCT STATUS DEFINITIONS

Definition of Terms

Datasheet Identification	Product Status	Definition
Advance Information	Formative / In Design	Datasheet contains the design specifications for product development. Specifications may change in any manner without notice.
Preliminary	First Production	Datasheet contains preliminary data; supplementary data will be published at a later date. Fairchild Semiconductor reserves the right to make changes at any time without notice to improve design.
No Identification Needed	Full Production	Datasheet contains final specifications. Fairchild Semiconductor reserves the right to make changes at any time without notice to improve the design.
Obsolete	Not In Production	Datasheet contains specifications on a product that is discontinued by Fairchild Semiconductor. The datasheet is for reference information only.

Rev. 137