

CSPEMI202AG

2 Channel Headset Microphone EMI Filter with ESD Protection

Product Description

The CSPEMI202AG is a dual low-pass filter array integrating two pi-style filters (C-R-C) that reduce EMI/RFI emissions while at the same time providing ESD protection. This part is custom-designed to interface with a microphone port on a cellular telephone or similar device. Each high quality filter provides more than 35 dB attenuation in the 800–2700 MHz range. These pi-style filters support bidirectional filtering, controlling EMI both to and from a microphone element. They also support bipolar signals, enabling audio signals to pass through without distortion.

In addition, the CSPEMI202AG provides a very high level of protection for sensitive electronic components that may be subjected to electrostatic discharge (ESD). The diodes safely dissipate ESD strikes of ± 8 kV, the maximum requirement of the IEC 61000-4-2 international standard. Using the MIL-STD-883 (Method 3015) specification for Human Body Model (HBM) ESD, the device provides protection for contact discharges to greater than ± 15 kV.

The CSPEMI202AG is particularly well-suited for portable electronics (e.g. cellular telephones, PDAs, notebook computers) because of its small package format and low weight. The CSPEMI202AG is available in a space-saving, low-profile Chip Scale Package with RoHS compliant lead-free finishing.

Features

- Two Channels of EMI Filtering
- Pi-Style EMI Filters in a Capacitor-Resistor-Capacitor (C-R-C) Network
- Greater than 40 dB Attenuation at 1 GHz
- ± 8 kV ESD Protection on each Channel (IEC 61000-4-2 Level 4, Contact Discharge)
- ± 15 kV ESD Protection on each Channel (HBM)
- Supports Bipolar Signals – Ideal for Audio Applications
- Chip Scale Package Features Extremely Low Lead Inductance for Optimum Filter and ESD Performance
- 5-Bump, 0.930 x 1.410 mm Footprint Chip Scale Package (CSP)
- These Devices are Pb-Free and are RoHS Compliant

Applications

- EMI Filtering and ESD Protection for Headset Microphone Ports
- Wireless Handsets
- Handheld PCs / PDAs
- MP3 Players
- Digital Camcorders
- Notebooks
- Desktop PCs



ON Semiconductor®

<http://onsemi.com>



WLCSP5
AG SUFFIX
CASE 567AZ

ELECTRICAL SCHEMATIC

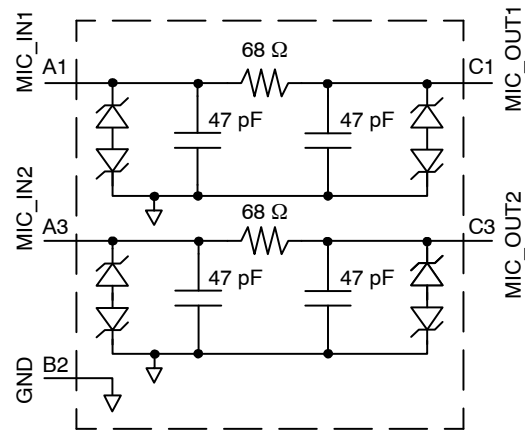

MARKING DIAGRAM

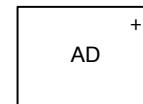

AD = CSPEMI202AG

ORDERING INFORMATION

Device	Package	Shipping†
CSPEMI202AG	CSP-5 (Pb-Free)	3500/Tape & Reel

†For information on tape and reel specifications, including part orientation and tape sizes, please refer to our Tape and Reel Packaging Specification Brochure, BRD8011/D.

CSPEMI202AG

Table 1. PIN DESCRIPTIONS

5-bump CSP Package		
Pin	Name	Description
A1	MIC_IN1	Microphone Input 1 (from microphone)
A3	MIC_IN2	Microphone Input 2 (from microphone)
B2	GND	Device Ground
C1	MIC_OUT1	Microphone Output 1 (to audio circuitry)
C3	MIC_OUT2	Microphone Output 2 (to audio circuitry)

PACKAGE / PINOUT DIAGRAMS

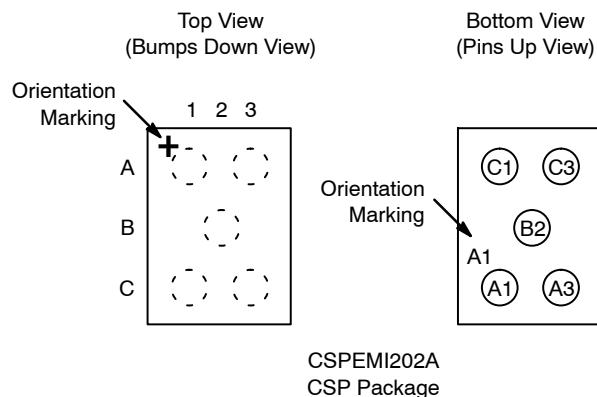

SPECIFICATIONS

Table 2. ABSOLUTE MAXIMUM RATINGS

Parameter	Rating	Units
Storage Temperature Range	-65 to +150	°C
DC Power per Resistor	100	mW
DC Package Power Rating	200	mW

Stresses exceeding Maximum Ratings may damage the device. Maximum Ratings are stress ratings only. Functional operation above the Recommended Operating Conditions is not implied. Extended exposure to stresses above the Recommended Operating Conditions may affect device reliability.

Table 3. STANDARD OPERATING CONDITIONS

Parameter	Rating	Units
Operating Temperature Range	-40 to +85	°C

Table 4. ELECTRICAL OPERATING CHARACTERISTICS (Note 1)

Symbol	Parameter	Conditions	Min	Typ	Max	Units
R_1	Resistance		61	68	75	Ω
C_1	Capacitance		38	47	56	pF
I_{LEAK}	Diode Leakage Current	$V_{IN} = 5.0\text{ V}$			1.0	μA
V_{SIG}	Signal Voltage Positive Clamp Negative Clamp	$I_{LOAD} = 10\text{ mA}$	5 -15	7 -10	15 -5	V
V_{ESD}	In-system ESD Withstand Voltage a) Human Body Model, MIL-STD-883, Method 3015 b) Contact Discharge per IEC 61000-4-2 Level 4	(Note 2)	± 15 ± 8			kV
V_{CL}	Clamping Voltage during ESD Discharge MIL-STD-883 (Method 3015), 8 kV Positive Transients Negative Transients	(Notes 2 and 3)		+15 -19		V
f_C	Cut-off frequency $Z_{SOURCE} = 50\ \Omega$, $Z_{LOAD} = 50\ \Omega$	$R = 68\ \Omega$, $C = 47\text{ pF}$		60		MHz

- $T_A = 25^\circ\text{C}$ unless otherwise specified.
- ESD applied to input and output pins with respect to GND, one at a time.
- Clamping voltage is measured at the opposite side of the EMI filter to the ESD pin. For example, if ESD is applied to Pin A1, then clamping voltage is measured at Pin C1.

CSPEM1202AG

PERFORMANCE INFORMATION

Typical Filter Performance (nominal conditions unless specified otherwise, 50 Ω Environment)

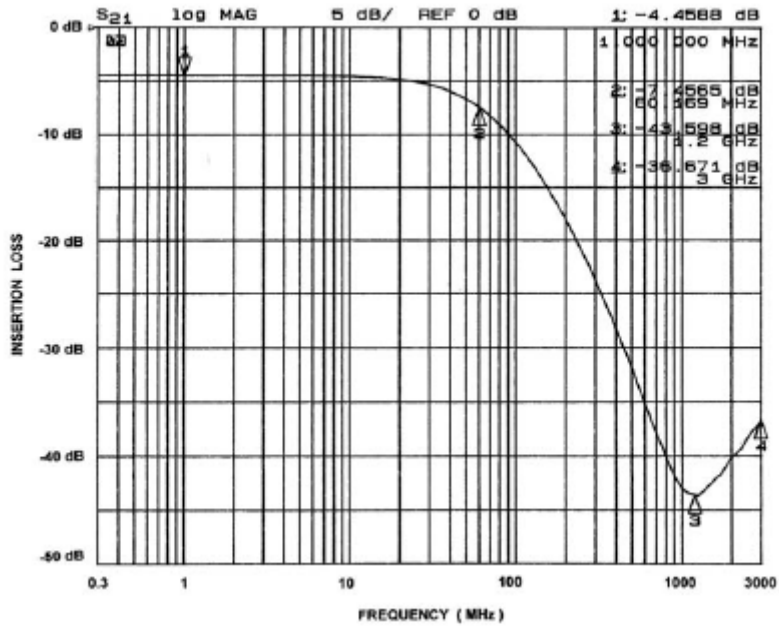

Figure 1. Insertion Loss vs. Frequency (A1-C1 to GND B2)

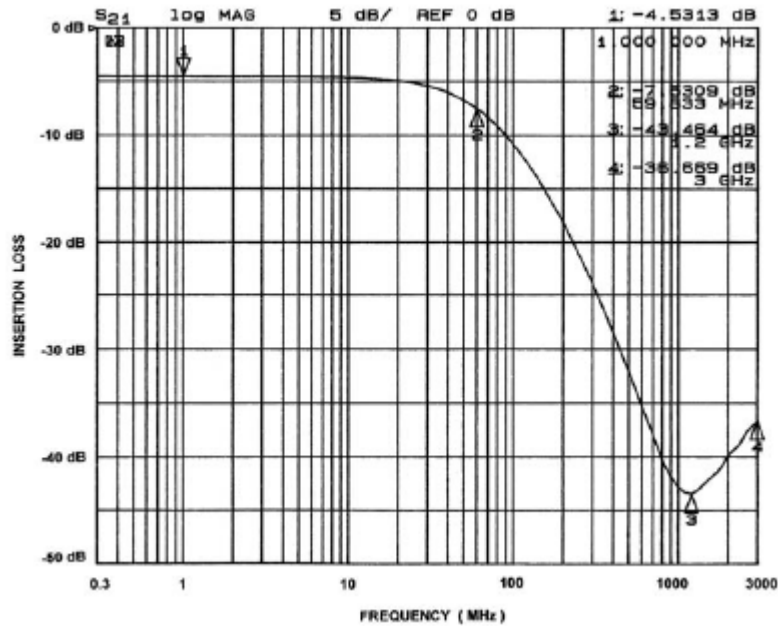

Figure 2. Insertion Loss vs. Frequency (A3-C3 to GND B2)

CSPEMI202AG

APPLICATION INFORMATION

Parameter	Value
Pad Size on PCB	0.240 mm
Pad Shape	Round
Pad Definition	Non-Solder Mask defined pads
Solder Mask Opening	0.290 mm Round
Solder Stencil Thickness	0.125 mm – 0.150 mm
Solder Stencil Aperture Opening (laser cut, 5% tapered walls)	0.300 mm Round
Solder Flux Ratio	50/50 by volume
Solder Paste Type	No Clean
Pad Protective Finish	OSP (Entek Cu Plus 106A)
Tolerance – Edge To Corner Ball	±50 μm
Solder Ball Side Coplanarity	±20 μm
Maximum Dwell Time Above Liquidous	60 seconds
Maximum Soldering Temperature for Lead-free Devices using a Lead-free Solder Paste	260°C

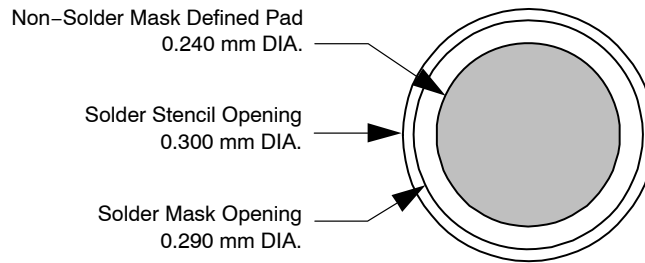

Figure 3. Recommended Non-Solder Mask Defined Pad Illustration

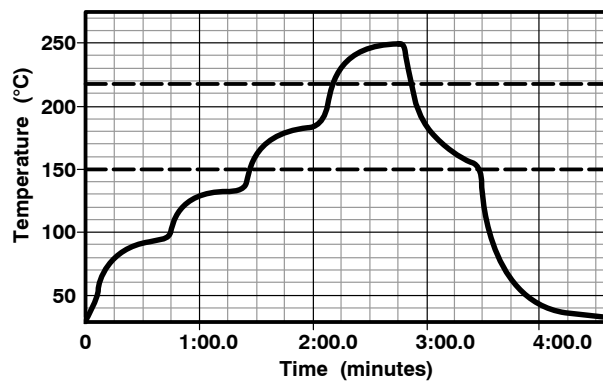
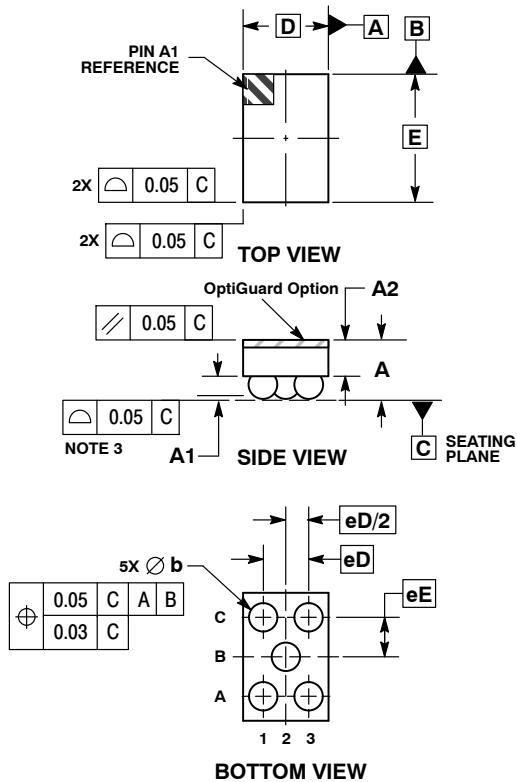

Figure 4. Lead-free (SnAgCu) Solder Ball Reflow Profile

CSPMI202AG

PACKAGE DIMENSIONS

WLCSP5, 0.94x1.41
CASE 567AZ-01
ISSUE O



NOTES:

1. DIMENSIONING AND TOLERANCING PER ASME Y14.5M, 1994.
2. CONTROLLING DIMENSION: MILLIMETERS.
3. COPLANARITY APPLIES TO SPHERICAL CROWNS OF SOLDER BALLS.

MILLIMETERS		
DIM	MIN	MAX
A	0.56	0.72
A1	0.21	0.27
A2	0.40 REF	
b	0.29	0.35
D	0.94 BSC	
E	1.41 BSC	
eD	0.50 BSC	
eE	0.435 BSC	

RECOMMENDED SOLDERING FOOTPRINT*

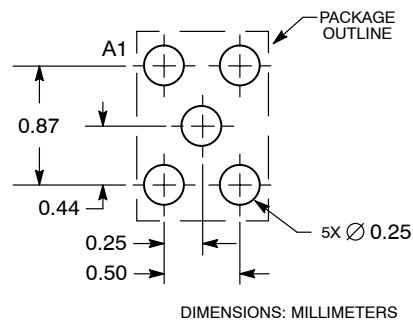

*For additional information on our Pb-Free strategy and soldering details, please download the ON Semiconductor Soldering and Mounting Techniques Reference Manual, SOLDERRM/D.

ON Semiconductor and are registered trademarks of Semiconductor Components Industries, LLC (SCILLC). SCILLC reserves the right to make changes without further notice to any products herein. SCILLC makes no warranty, representation or guarantee regarding the suitability of its products for any particular purpose, nor does SCILLC assume any liability arising out of the application or use of any product or circuit, and specifically disclaims any and all liability, including without limitation special, consequential or incidental damages. "Typical" parameters which may be provided in SCILLC data sheets and/or specifications can and do vary in different applications and actual performance may vary over time. All operating parameters, including "Typicals" must be validated for each customer application by customer's technical experts. SCILLC does not convey any license under its patent rights nor the rights of others. SCILLC products are not designed, intended, or authorized for use as components in systems intended for surgical implant into the body, or other applications intended to support or sustain life, or for any other application in which the failure of the SCILLC product could create a situation where personal injury or death may occur. Should Buyer purchase or use SCILLC products for any such unintended or unauthorized application, Buyer shall indemnify and hold SCILLC and its officers, employees, subsidiaries, affiliates, and distributors harmless against all claims, costs, damages, and expenses, and reasonable attorney fees arising out of, directly or indirectly, any claim of personal injury or death associated with such unintended or unauthorized use, even if such claim alleges that SCILLC was negligent regarding the design or manufacture of the part. SCILLC is an Equal Opportunity/Affirmative Action Employer. This literature is subject to all applicable copyright laws and is not for resale in any manner.

PUBLICATION ORDERING INFORMATION

LITERATURE FULFILLMENT:
Literature Distribution Center for ON Semiconductor
P.O. Box 5163, Denver, Colorado 80217 USA
Phone: 303-675-2175 or 800-344-3860 Toll Free USA/Canada
Fax: 303-675-2176 or 800-344-3867 Toll Free USA/Canada
Email: orderlit@onsemi.com

N. American Technical Support: 800-282-9855 Toll Free USA/Canada
Europe, Middle East and Africa Technical Support:
Phone: 421 33 790 2910
Japan Customer Focus Center
Phone: 81-3-5773-3850

ON Semiconductor Website: www.onsemi.com
Order Literature: <http://www.onsemi.com/orderlit>
For additional information, please contact your local Sales Representative