

Customer Information Sheet

DRAWING No.: M22-634XX42R

SHEET 3 OF 4

IF IN DOUBT - ASK

©

NOT TO SCALE

THIRD ANGLE PROJECTION

ALL DIMENSIONS IN mm

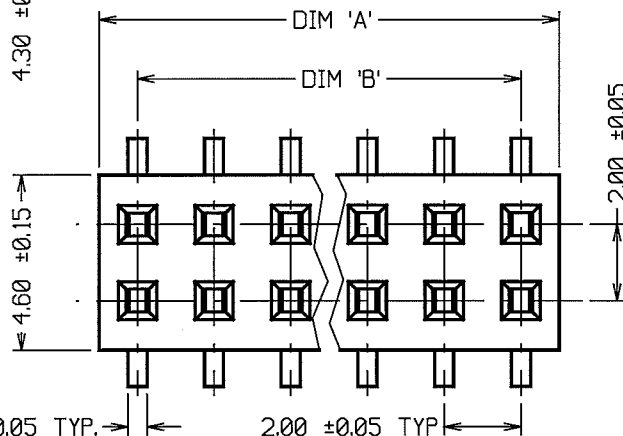
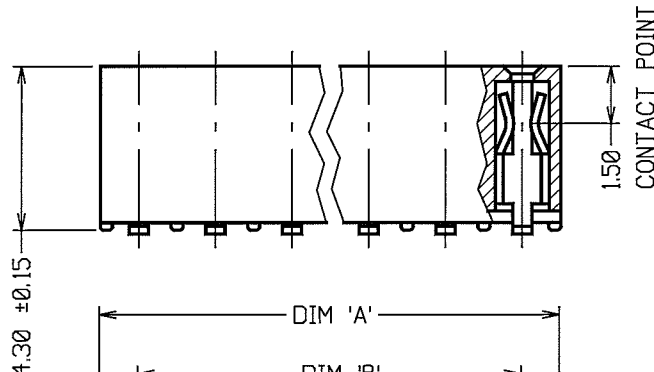
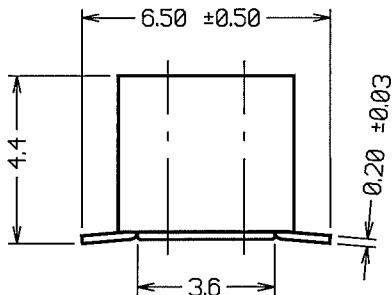

SPECIFICATION:

MATERIAL:
 MOULDING - HIGH TEMP PLASTIC UL94V-0, BLACK
 CONTACT - COPPER ALLOY
FINISH:
 GOLD FLASH OVER 1.3µ NICKEL ON CONTACT AREA,
 100% TIN ON TAILS.

ELECTRICAL:
 CURRENT RATING = 1A
 INSULATION RESISTANCE = 5,000 MEGOHMS MIN.
 CONTACT RESISTANCE = 20 MILLIOHMS MAX.
 VOLTAGE PROOF = 1000V AC

MECHANICAL:
 INSERTION FORCE = 2.9N MAX.
 WITHDRAWAL FORCE = 0.25N MIN.
 DURABILITY = 500 CYCLES

ENVIRONMENTAL:
 OPERATING TEMPERATURE = -40°C TO +105°C

FOR COMPLETE MECHANICAL/ELECTRICAL SPECIFICATION,
 SEE COMPONENT SPECIFICATION C018XX (LATEST ISSUE).

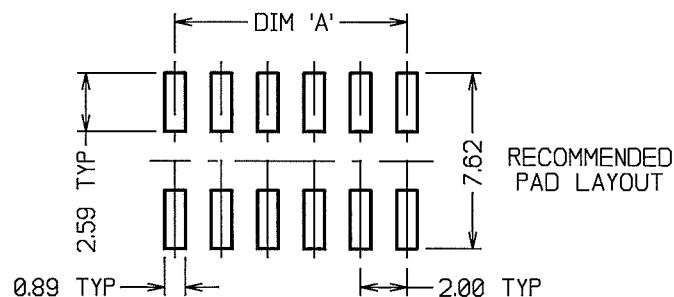

PART No.	DIM 'A'	DIM 'B'
M22-6340342R	4.00	6.50
M22-6340542R	8.00	10.50
M22-6340642R	10.00	12.50
M22-6341042R	18.00	20.50
M22-6342542R	48.00	50.50

NOTES:

- FOR REELING DETAILS, SEE SHEET 4.
- COPLANARITY OF CONTACTS TO BE 0.1mm MAX.

ORDER CODE:

M22-634XX42R

No. OF WAYS PER ROW _____
 03, 05, 06, 10, 25

FINISH: _____
 42 = SELECTIVE GOLD + 100% TIN

RA	11	20.01.09	10265
NAME	ISS.	DATE	C/NOTE
APPROVED:	<i>[Signature]</i>		
CHECKED:	<i>[Signature]</i>		
DRAWN:	WJ BOURNE		
CUSTOMER REF.:			
ASSEMBLY DRG:			

HARWIN

HARWIN USA
 TEL: 603 893 5376
 FAX: 603 893 5396
 mls@harwin.com

HARWIN Europe (UK)
 TEL: 023 9231 4545
 FAX: 023 9231 4590
 mls@harwin.co.uk

HARWIN Asia
 TEL: +65 6 779 4909
 FAX: +65 6 779 3868
 mls@harwin.com.sg

THIS DRAWING AND ANY INFORMATION OR DESCRIPTIVE MATTER SET OUT HEREON ARE CONFIDENTIAL AND COPYRIGHT PROPERTY OF THE HARWIN GROUP AND MUST NOT BE DISCLOSED, LOANED, COPIED OR USED FOR MANUFACTURING, TENDERING OR FOR ANY OTHER PURPOSE WITHOUT THEIR WRITTEN PERMISSION.

TOLERANCES
 X. - ±1mm
 X.X - ±0.25mm
 X.XX - ±0.10mm
 X.XXX - ±0.01mm
 ANGLES = ±5°
 UNLESS STATED

MATERIAL:
 SEE ABOVE
FINISH: SEE ABOVE
S/AREA: mm²

TITLE: 2mm PITCH DIL SMT LOW PROFILE SOCKET ASSY (PICK & PLACE, TAPE & REEL)
DRAWING NUMBER:
M22-634XX42R

Customer Information Sheet

DRAWING No.: M22-634XX42R

SHEET 4 OF 4

IF IN DOUBT - ASK

©

NOT TO SCALE

THIRD ANGLE PROJECTION

ALL DIMENSIONS IN mm

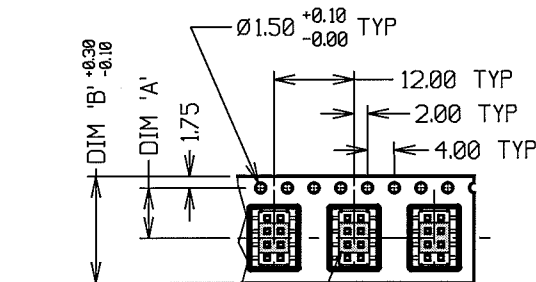

PICK AND PLACE TAPE

STYLE FOR 3-WAY

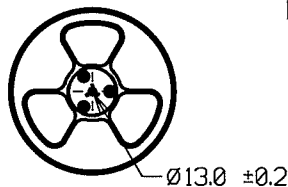
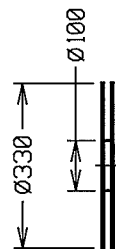
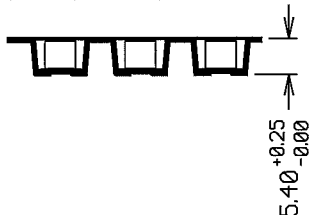

REEL DETAILS

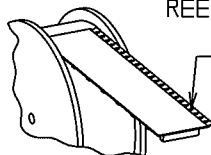

FINISHED REELING DIRECTION

ROUND HOLES

TAPE DETAILS

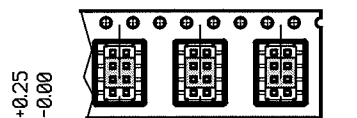

STYLE FOR 5-WAY



STYLE FOR 25-WAY

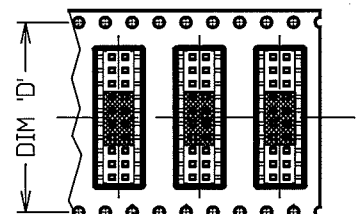

STYLE FOR 6-WAY

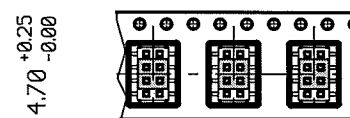

STYLE FOR 10-WAY

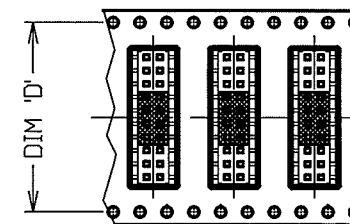

ORDER CODE:

M22-634XX42R

No. OF WAYS PER ROW: 03, 05, 06, 10, 25

FINISH: 42 - SELECTIVE GOLD + 100% TIN

NOTES:

- FOR CONNECTOR DIMENSIONS, SEE SHEET 3.
- FOR QUANTITY OF COMPONENTS PER REEL, SEE TABLE.
- TAPE THICKNESS = 0.40 ± 0.05mm.
- TAPE & REEL TO BE IN ACCORDANCE WITH ELECTRONIC INDUSTRIES ASSOCIATION EIA-481.

PART NUMBER	DIM 'A'	DIM 'B'	DIM 'D'	QTY/REEL
M22-6340342R	7.50	16.00		1,100
M22-6340542R	11.50	24.00		900
M22-6340642R	11.50	24.00		1,100
M22-6341042R	14.20	32.00	28.40	1,100
M22-6342542R	34.20	72.00	68.40	900

RA	11	20.01.09	10265
NAME	ISS.	DATE	C/NOTE
APPROVED:			
CHECKED:			
DRAWN: W. J. BOURNE			
CUSTOMER REF.:			
ASSEMBLY DRG:			

HARWIN

HARWIN USA
TEL: 603 893 5376
FAX: 603 893 5396
misa@harwin.com

HARWIN Europe (UK)
TEL: 023 9231 4545
FAX: 023 9231 4590
misa@harwin.co.uk

HARWIN Asia
TEL: +65 6 779 4909
FAX: +65 6 779 3868
misa@harwin.com.sg

THIS DRAWING AND ANY INFORMATION OR DESCRIPTIVE MATTER SET OUT HEREON ARE CONFIDENTIAL AND COPYRIGHT PROPERTY OF THE HARWIN GROUP AND MUST NOT BE DISCLOSED, LOANED, COPIED OR USED FOR MANUFACTURING, TENDERING OR FOR ANY OTHER PURPOSE WITHOUT THEIR WRITTEN PERMISSION.

TOLERANCES
X. - ±1mm
X.X - ±0.25mm
X.XX - ±0.10mm
X.XXX - ±0.01mm
ANGLES - ±5°
UNLESS STATED

MATERIAL: SEE ABOVE
FINISH: SEE ABOVE
S/AREA: mm²

TITLE: 2mm PITCH DIL SMT LOW PROFILE SOCKET ASSY (PICK & PLACE, TAPE & REEL)

DRAWING NUMBER: M22-634XX42R

SHT 4 OF 4