

**Product Description**

The PE43703 is a HaRP™-enhanced, high linearity, 7-bit RF Digital Step Attenuator (DSA). This highly versatile DSA covers a 31.75 dB attenuation range in 0.25 dB, 0.5 dB, or 1.0 dB steps. The customer can choose which step size and associated specifications are best suited for their application. The Peregrine 50Ω RF DSA provides multiple CMOS control interfaces and an optional external V<sub>SS</sub> feature. It maintains high attenuation accuracy over frequency and temperature and exhibits very low insertion loss and low power consumption. Performance does not change with V<sub>DD</sub> due to on-board regulator. This next generation Peregrine DSA is available in a 5x5 mm 32-lead QFN footprint.

The PE43703 is manufactured on Peregrine's UltraCMOS™ process, a patented variation of silicon-on-insulator (SOI) technology on a sapphire substrate, offering the performance of GaAs with the economy and integration of conventional CMOS.

**Figure 1. Package Type**

32-lead 5x5x0.85 mm QFN Package

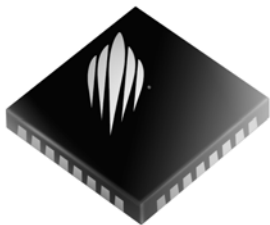

**Figure 2. Functional Schematic Diagram**

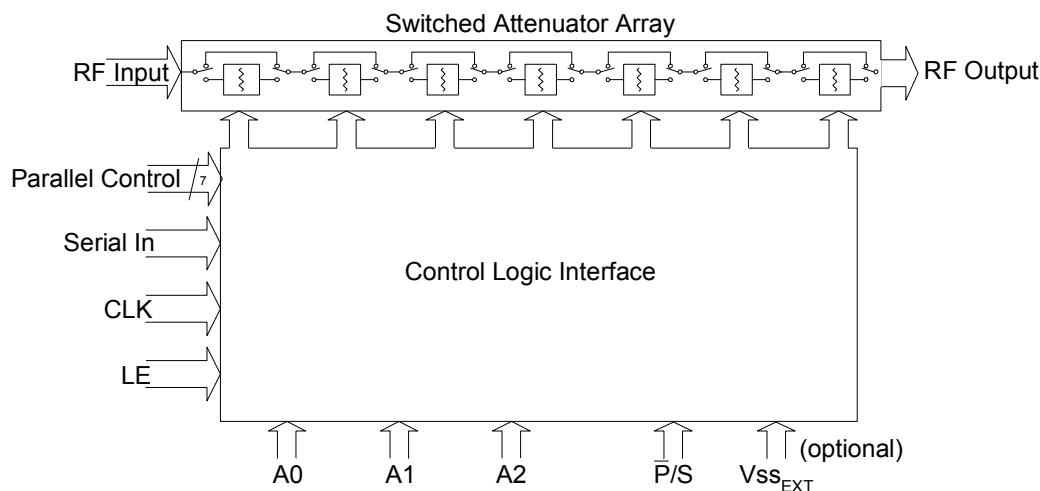

**50 Ω RF Digital Attenuator**  
**7-bit, 31.75 dB, 9 kHz - 6000 MHz**  
**V<sub>SS</sub>EXT option**

**Features**

- HaRP™-enhanced UltraCMOS™ device
- Attenuation options: 0.25 dB, 0.5 dB, or 1.0 dB steps to 31.75 dB
  - 0.25 dB monotonicity for ≤ 4.0 GHz
  - 0.5 dB monotonicity for ≤ 5.0 GHz
  - 1 dB monotonicity for ≤ 6.0 GHz
- High Linearity: Typical +59 dBm IIP3
  - Excellent low-frequency performance
- Optional External V<sub>SS</sub> Control (V<sub>SS</sub>EXT)
- 3.3 V or 5.0 V Power Supply Voltage
- Fast switch settling time
- Programming Modes:
  - Direct Parallel
  - Latched Parallel
  - Serial-Addressable: Program up to eight addresses 000 - 111
- High-attenuation state @ power-up (PUP)
- CMOS Compatible
- No DC blocking capacitors required

**Table 1. Electrical Specifications: 0.25 dB steps @ +25°C, V<sub>DD</sub> = 3.3 V or 5.0 V, V<sub>SS\_EXT</sub> = -2.7 V or GND**

Parameter	Test Conditions	Frequency	Min	Typical	Max	Units
Frequency Range			9 kHz		4000 MHz	
Attenuation Range	0.25 dB Step			0 – 31.75		dB
Insertion Loss		9 kHz ≤ 4 GHz		1.9	2.4	dB
Attenuation Error	0 dB - 7.75 dB Attenuation settings	9 kHz < 3 GHz			±(0.2+1.5%)	dB
	8 dB - 31.75 dB Attenuation settings	9 kHz < 3 GHz			±(0.15+4%)	dB
	0 dB - 31.75 dB Attenuation settings	3 GHz < 4 GHz			±(0.25+4.5%)	dB
Return Loss		9 kHz - 4 GHz		18		dB
Relative Phase	All States	9 kHz - 4 GHz		33		deg
P1dB (note 1)	Input	20 MHz - 4 GHz	30	32		dBm
IIP3	Two tones at +18 dBm, 20 MHz spacing	20 MHz - 4 GHz		59		dBm
Typical Spurious Value <sup>2</sup>	V <sub>SS_EXT</sub> grounded	1 MHz		-110		dBm
Video Feed Through				10		mVpp
Switching Time	50% DC CTRL to 10% / 90% RF			650		ns
RF Trise/Tfall	10% / 90% RF			400		ns
Settling Time	RF settled to within 0.05 dB of final value. RBW = 5 MHz, Averaging ON.			4	25	μs

Notes: 1. Please note Maximum Operating Pin (50Ω) of +23dBm as shown in Table 5.  
2. To prevent negative voltage generator spurs, supply -2.7 volts to V<sub>SS\_EXT</sub>.

### Performance Plots, 0.25 dB step

**Figure 3. 0.25 dB Step Attenuation\***

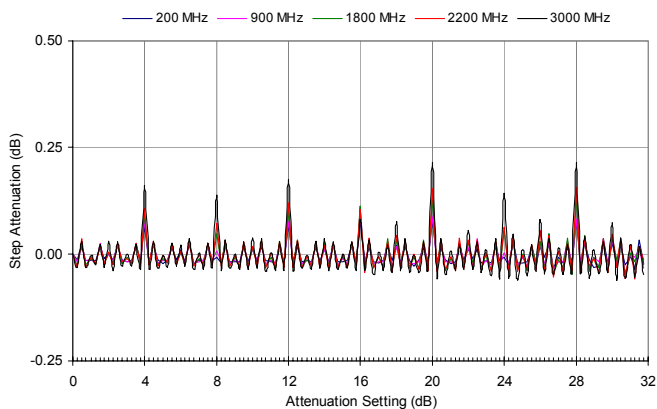

\*Monotonicity is held so long as Step-Attenuation does not cross below -0.25

**Figure 5. 0.25 dB Major State Bit Error**

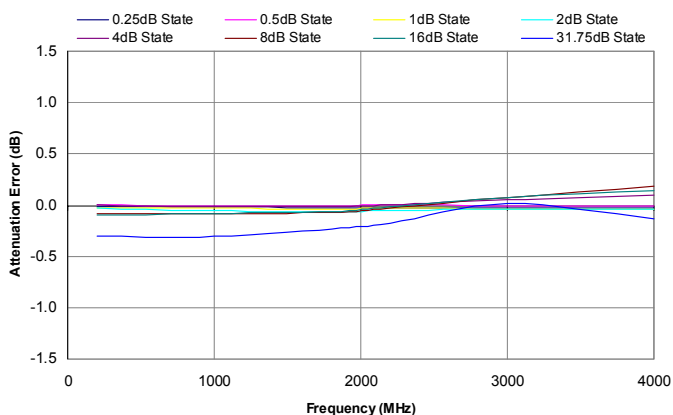

**Figure 4. 0.25 dB Step, Actual vs. Ideal Attenuation**

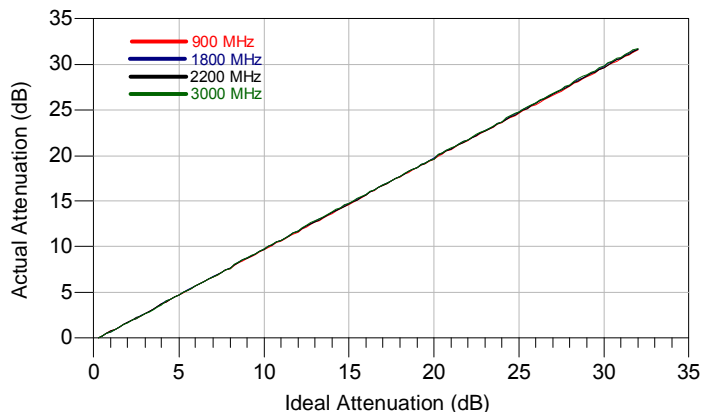

**Figure 6. 0.25 dB Attenuation Error**

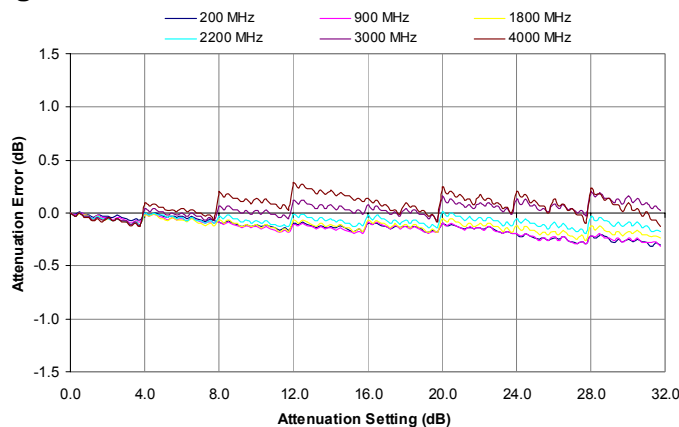

**Table 2. Electrical Specifications: 0.5 dB steps @ +25°C, V<sub>DD</sub> = 3.3 V or 5.0 V, V<sub>SS</sub>EXT = -2.7 V or GND**

Parameter	Test Conditions	Frequency	Min	Typical	Max	Units
Frequency Range			9 kHz		5000 MHz	
Attenuation Range	0.5 dB Step			0 – 31.5		dB
Insertion Loss		9 kHz ≤ 5 GHz		2.0	2.6	dB
Attenuation Error	0 dB - 31.5 dB Attenuation settings 0 dB - 16.5 dB Attenuation settings 17 dB - 31.5 dB Attenuation settings	9 kHz < 4 GHz			±(0.25+4.5%)	dB
		4 ≤ 5 GHz			±(0.3+5%)	dB
		4 ≤ 5 GHz			±(1.3+0%)	dB
Return Loss		9 kHz - 5 GHz		18		dB
Relative Phase	All States	9 kHz - 5 GHz		56		deg
P1dB (note 1)	Input	20 MHz - 5 GHz	30	32		dBm
IIP3	Two tones at +18 dBm, 20 MHz spacing	20 MHz - 5 GHz		57		dBm
Typical Spurious Value <sup>2</sup>	V <sub>SS</sub> EXT grounded	1 MHz		-110		dBm
Video Feed Through				10		mVpp
Switching Time	50% DC CTRL to 10% / 90% RF			650		ns
RF Trise/Tfall	10% / 90% RF			400		ns
Settling Time	RF settled to within 0.05 dB of final value. RBW = 5 MHz, Averaging ON.			4	25	µs

Notes: 1. Please note Maximum Operating Pin (50Ω) of +23dBm as shown in Table 5.  
2. To prevent negative voltage generator spurs, supply -2.7 volts to V<sub>SS</sub>EXT.

**Performance Plots, 0.5 dB step**

**Figure 7. 0.5 dB Step Attenuation\***

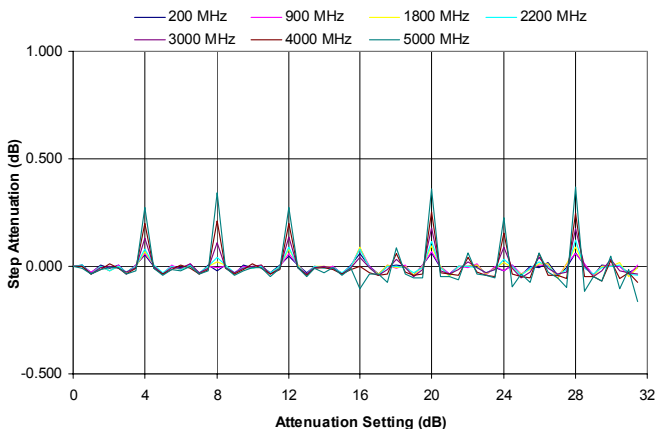

\*Monotonicity is held so long as Step-Attenuation does not cross below -0.5

**Figure 9. 0.5 dB Major State Bit Error**

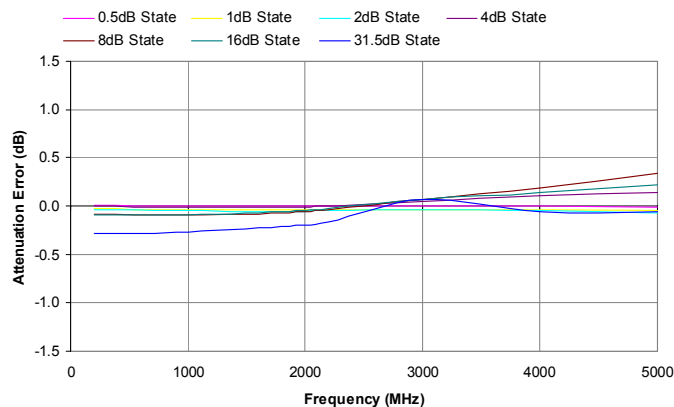

**Figure 8. 0.5 dB Step, Actual vs. Ideal Attenuation**

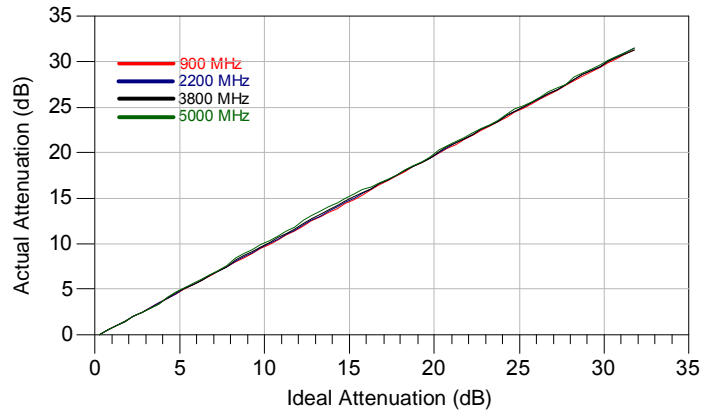

**Figure 10. 0.5 dB Attenuation Error**

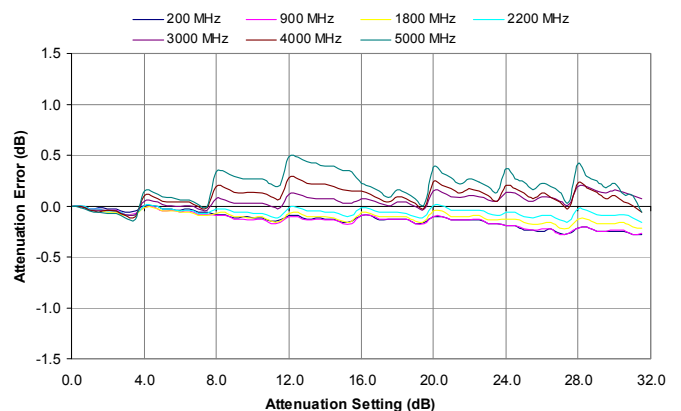

**Table 3. Electrical Specifications: 1 dB steps @ +25°C, V<sub>DD</sub> = 3.3 V or 5.0 V, V<sub>SS</sub>EXT = -2.7 V or GND**

Parameter	Test Conditions	Frequency	Min	Typical	Max	Units
Frequency range			9 kHz		6000 MHz	
Attenuation Range	1 dB Step			0 - 31		dB
Insertion Loss		9 kHz ≤ 6 GHz		2.3	2.8	dB
Attenuation Error	0 dB - 31 dB Attenuation settings	9 kHz - 4 GHz			±(0.25+4.5%)	dB
	0 dB - 12 dB Attenuation settings	4 GHz ≤ 6 GHz			+0.4+8%	dB
	13 dB - 31 dB Attenuation setting	4 GHz ≤ 6 GHz			+1.4+0%	dB
	0 dB - 31 dB Attenuation settings	4 GHz ≤ 6 GHz			-0.2-3%	dB
Return Loss		9 kHz - 6 GHz		18		dB
Relative Phase	All States	9 kHz - 6 GHz		74		deg
P1dB (note 1)	Input	20 MHz - 6 GHz	30	32		dBm
IIP3	Two tones at +18 dBm, 20 MHz spacing	20 MHz - 6 GHz		53		dBm
Typical Spurious Value <sup>2</sup>	V <sub>SS</sub> EXT grounded	1 MHz		-110		dBm
Video Feed Through				10		mVpp
Switching Time	50% DC CTRL to 10% / 90% RF			650		ns
RF Trise/Tfall	10% / 90% RF			400		ns
Settling Time	RF settled to within 0.05 dB of final value. RBW = 5 MHz, Averaging ON.			4	25	µs

Notes: 1. Please note Maximum Operating Pin (50Ω) of +23dBm as shown in Table 5.  
2. To prevent negative voltage generator spurs, supply -2.7 volts to V<sub>SS</sub>EXT.

**Performance Plots, 1 dB step**

**Figure 11. 1 dB Step Attenuation**

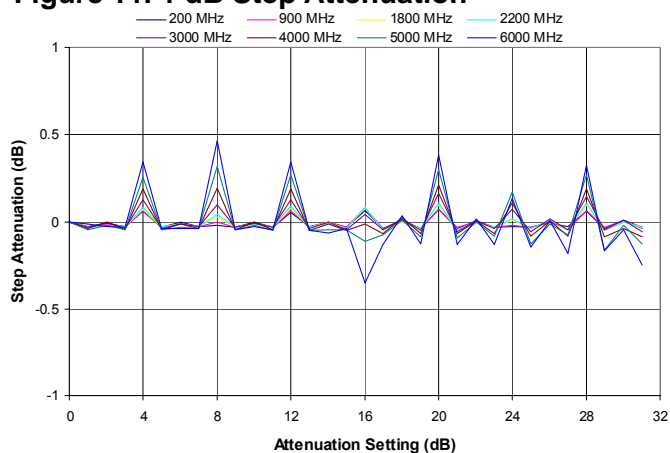

\*Monotonicity is held so long as Step-Attenuation not cross below -1

**Figure 13. 1 dB Major State Bit Error**

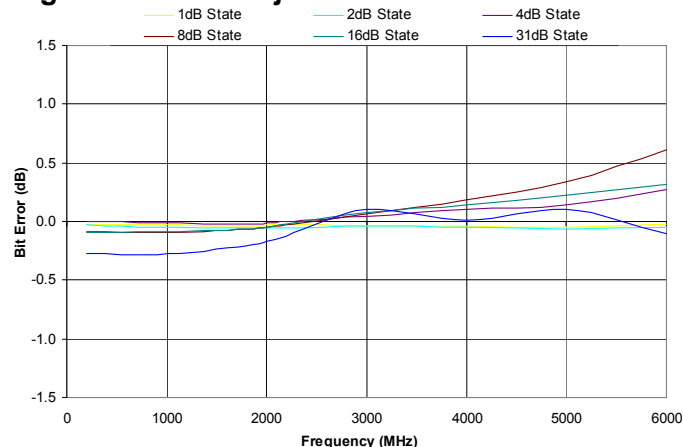

**Figure 12. 1 dB Step, Actual vs. Ideal Attenuation**

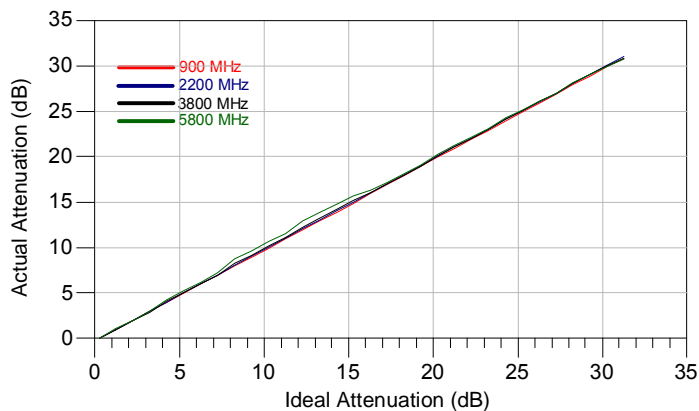

**Figure 14. 1 dB Attenuation Error**

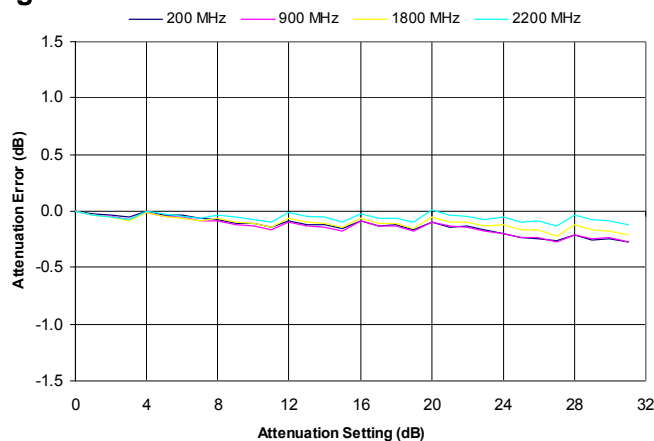

Performance Plots, 1 dB step (continued)

Figure 15. 1 dB Attenuation Error (continued)

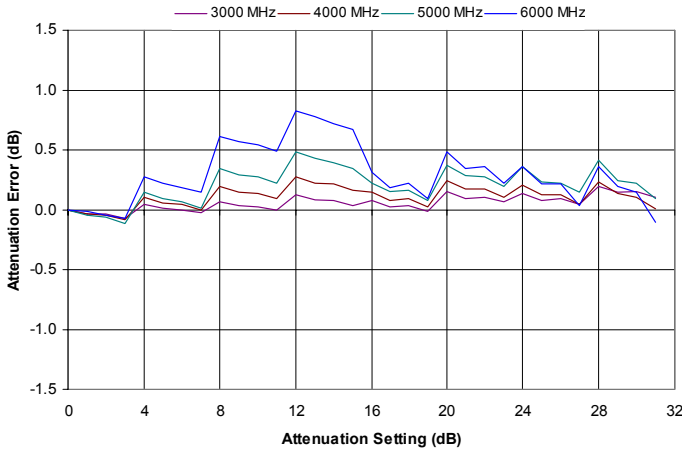

Figure 16. Insertion Loss @ Temperature

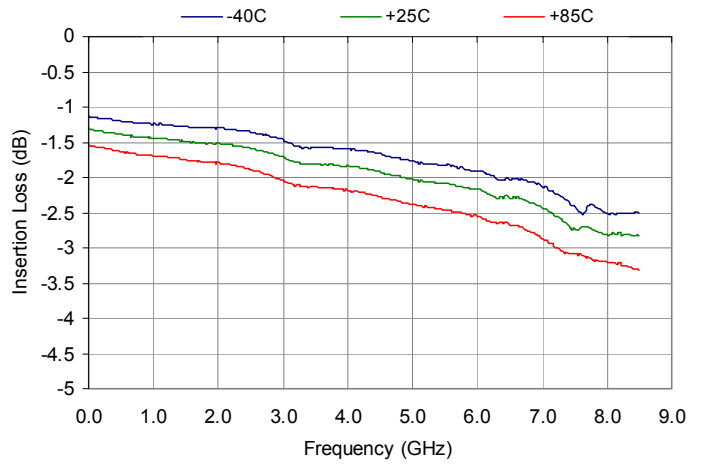

Figure 17. Input Return Loss (+25C)

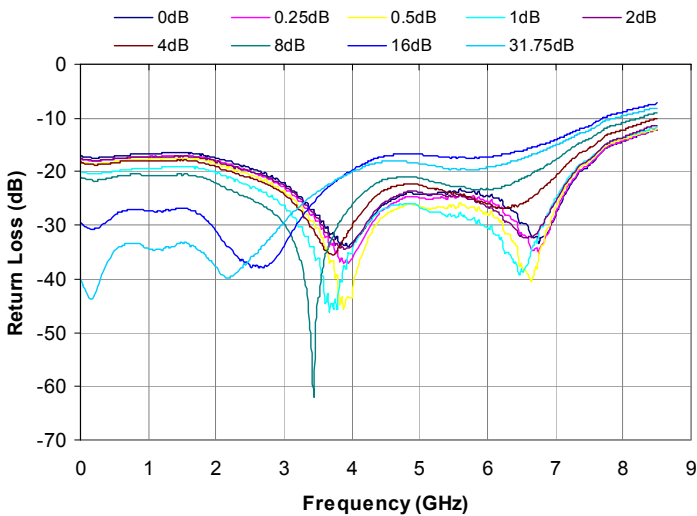

Figure 18. Output Return Loss (+25C)

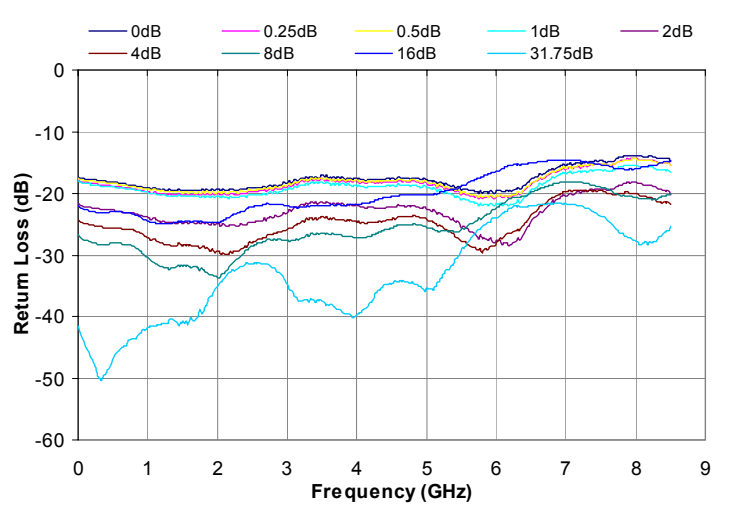

Figure 19. Input Return Loss @ Temperature for 16 dB State

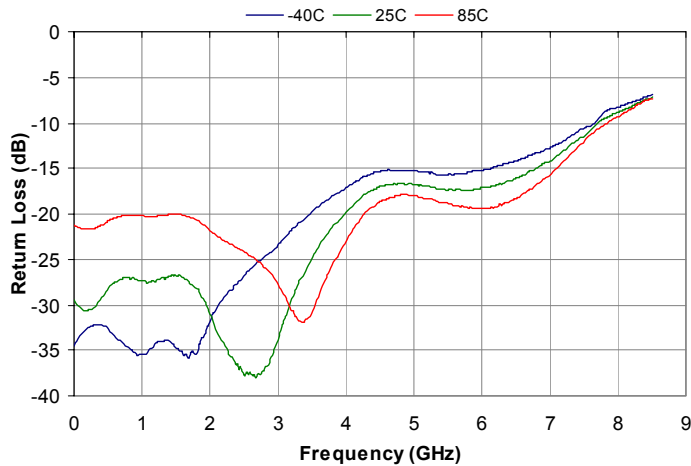
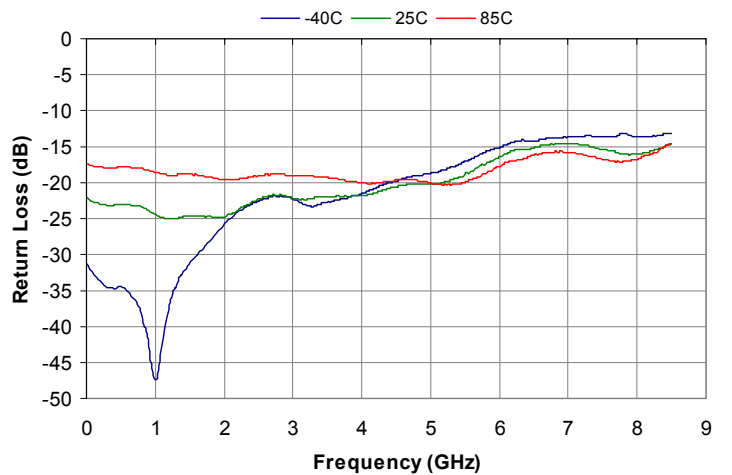

Figure 20. Output Return Loss @ Temperature for 16 dB State



Performance Plots (continued)

Figure 21. Relative Phase Error

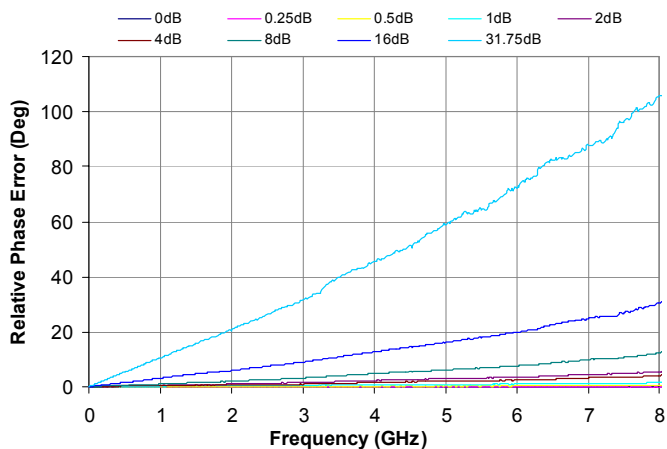

Figure 22. Relative Phase Error vs. Temperature for 31.75 dB State

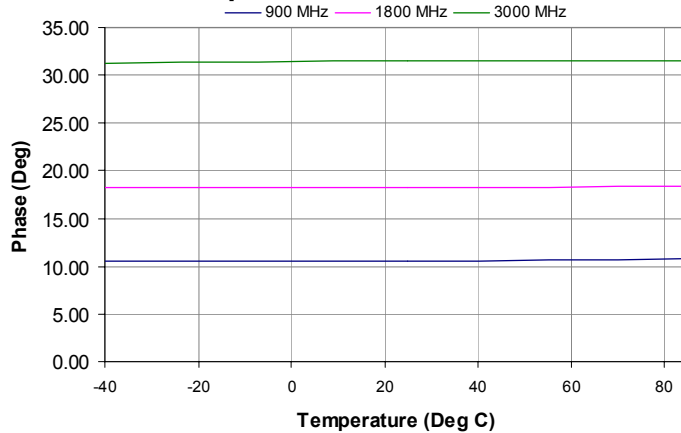

Figure 23. Attenuation Error @ 900 MHz

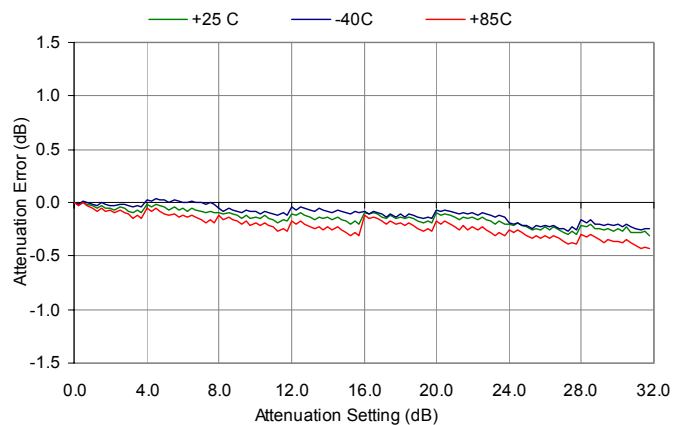

Figure 24. Attenuation Error @ 1800 MHz

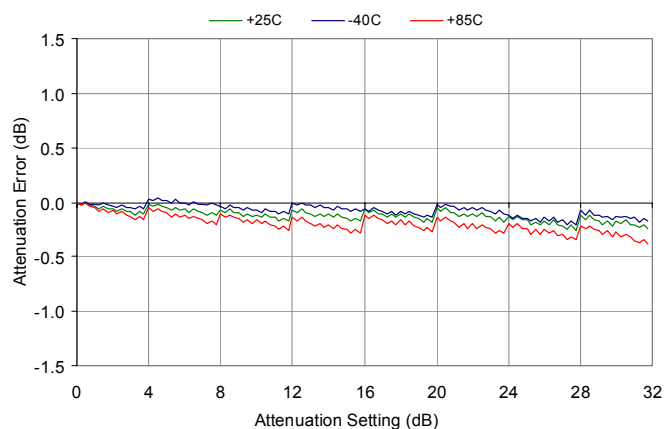

Figure 25. Attenuation Error @ 3000 MHz

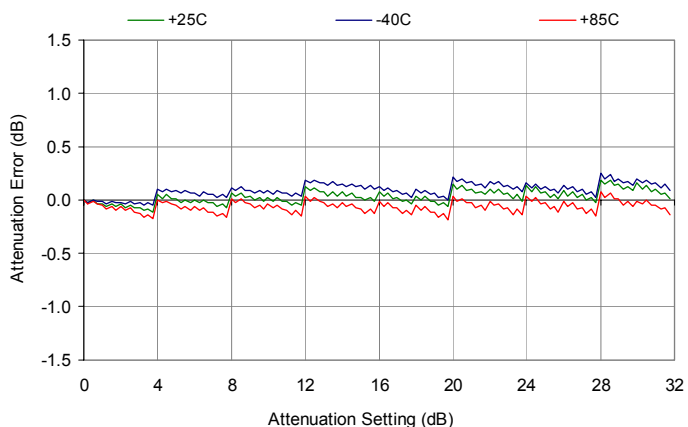
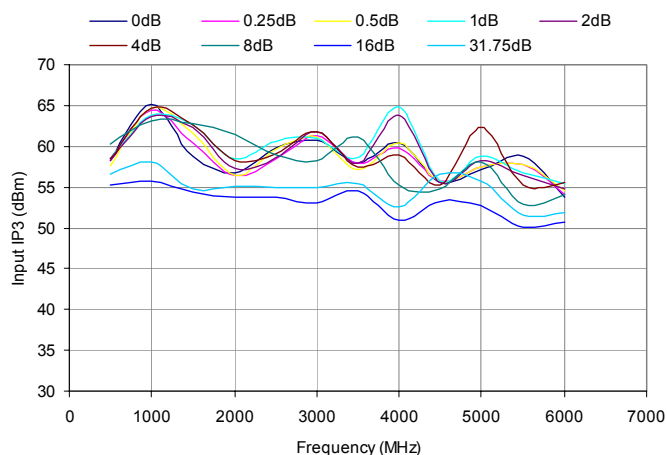
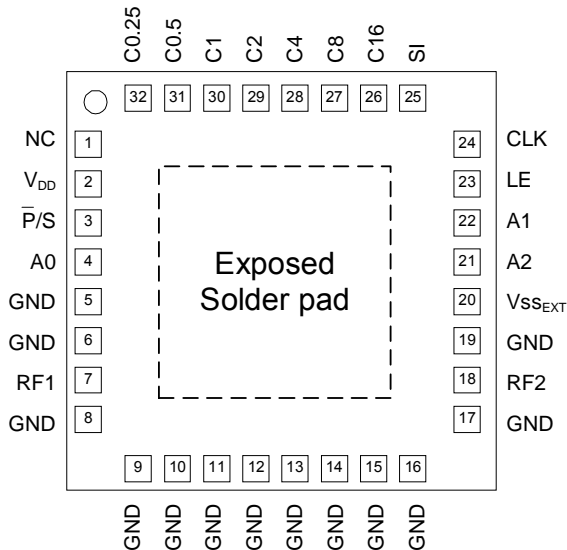

Figure 26. Input IP3 vs. Frequency



**Figure 27. Pin Configuration (Top View)**



**Table 4. Pin Descriptions**

Pin No.	Pin Name	Description
1	N/C	No Connect
2	V <sub>DD</sub>	Power supply pin
3	P/S	Serial/Parallel mode select
4	A0	Address Bit A0 connection
5	GND	Ground
6	GND	Ground
7	RF1	RF1 port
8 - 17	GND	Ground
18	RF2	RF2 port
19	GND	Ground
20	V <sub>SS_EXT</sub>	External Vss Control
21	A2	Address Bit A2 connection
22	A1	Address Bit A1 connection
23	LE	Serial interface Latch Enable input
24	CLK	Serial interface Clock input
25	SI	Serial interface Data input
26	C16 (D6)	Parallel control bit, 16 dB
27	C8 (D5)	Parallel control bit, 8 dB
28	C4 (D4)	Parallel control bit, 4 dB
29	C2 (D3)	Parallel control bit, 2 dB
30	C1 (D2)	Parallel control bit, 1 dB
31	C0.5 (D1)	Parallel control bit, 0.5 dB
32	C0.25 (D0)	Parallel control bit, 0.25 dB
Paddle	GND	Ground for proper operation

Note: Ground C0.25, C0.5, C1 C2, C4, C8, C16 if not in use.

### Electrostatic Discharge (ESD) Precautions

When handling this UltraCMOS™ device, observe the same precautions that you would use with other ESD-sensitive devices. Although this device contains circuitry to protect it from damage due to ESD, precautions should be taken to avoid exceeding the specified rating.

### Latch-Up Avoidance

Unlike conventional CMOS devices, UltraCMOS™ devices are immune to latch-up.

### Optional External Vss Control (V<sub>SS\_EXT</sub>)

For proper operation, the V<sub>SS\_EXT</sub> control must be grounded or at the V<sub>SS</sub> voltage specified in the Operating Ranges table. When the V<sub>SS\_EXT</sub> control pin on the package is grounded the switch FET's are biased with an internal low spur negative voltage generator. For applications that require the lowest possible spur performance, V<sub>SS\_EXT</sub> can be applied to bypass the internal negative voltage generator to eliminate the spurs.

### Switching Frequency

The PE43703 has a maximum 25 kHz switching rate when V<sub>SS\_EXT</sub> is grounded. Switching rate is defined to be the speed at which the DSA can be toggled across attenuation states.

### Moisture Sensitivity Level

The Moisture Sensitivity Level rating for the PE43703 in the 5x5 QFN package is MSL1.

### Exposed Solder Pad Connection

The exposed solder pad on the bottom of the package must be grounded for proper device operation.

**Table 5. Operating Ranges**

Parameter	Min	Typ	Max	Units
V <sub>DD</sub> 3.3 V Power Supply Voltage	3.0	3.3	3.6	V
V <sub>DD</sub> 5.0 V Power Supply Voltage	4.5	5.0	5.5	V
V <sub>SS</sub> <sub>EXT</sub> Negative Power Supply Voltage <sup>1</sup>	-3.0	-2.7	-2.4	V
I <sub>DD</sub> Power Supply Current		70	350	μA
Digital Input High	2.6		5.5	V
P <sub>IN</sub> Input power (50Ω): 9 kHz ≤ 20 MHz 20 MHz ≤ 6 GHz			See fig. 28 +23	dBm dBm
T <sub>OP</sub> Operating temperature range	-40	25	85	°C
Digital Input Low	0		1	V
Digital Input Leakage			15	μA

Note: 1. Applied only when external VSS power supply used. Pin 20 must be grounded when using internal Vss supply

**Table 6. Absolute Maximum Ratings**

Symbol	Parameter/Conditions	Min	Max	Units
V <sub>DD</sub>	Power supply voltage	-0.3	6.0	V
V <sub>SS</sub> <sub>EXT</sub>	Vss External Negative Power Supply Voltage (optional)	-4.0	0.3	V
V <sub>I</sub>	Voltage on any Digital input	-0.3	5.8	V
P <sub>IN</sub>	Input power (50Ω) 9 kHz ≤ 20 MHz 20 MHz ≤ 6 GHz		See fig. 28 +23	dBm dBm
T <sub>ST</sub>	Storage temperature range	-65	150	°C
V <sub>ESD</sub>	ESD voltage (HBM) <sup>1</sup> ESD voltage (Machine Model)		500 100	V V

Note: 1. Human Body Model (HBM, MIL\_STD 883 Method 3015.7)

Exceeding absolute maximum ratings may cause permanent damage. Operation should be restricted to the limits in the Operating Ranges table. Operation between operating range maximum and absolute maximum for extended periods may reduce reliability.

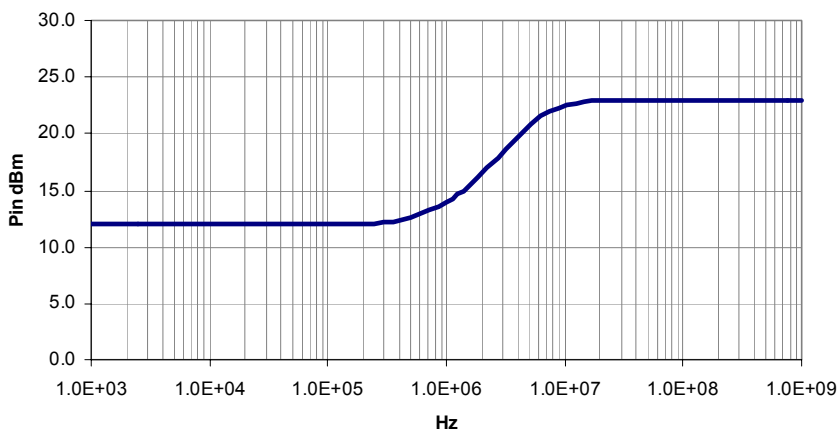
**Figure 28. Maximum Power Handling Capability: Z<sub>0</sub> = 50 Ω**

**Table 7. Control Voltage**

State	Bias Condition
Low	0 to +1.0 Vdc at 2 $\mu$ A (typ)
High	+2.6 to +5 Vdc at 10 $\mu$ A (typ)

**Table 8. Latch and Clock Specifications**

Latch Enable	Shift Clock	Function
0	$\uparrow$	Shift Register Clocked
$\uparrow$	X	Contents of shift register transferred to attenuator core

**Table 9. Parallel Truth Table**

Parallel Control Setting							Attenuation Setting RF1-RF2
D6	D5	D4	D3	D2	D1	D0	
L	L	L	L	L	L	L	Reference I.L.
L	L	L	L	L	L	H	0.25 dB
L	L	L	L	L	H	L	0.5 dB
L	L	L	L	H	L	L	1 dB
L	L	L	H	L	L	L	2 dB
L	L	H	L	L	L	L	4 dB
L	H	L	L	L	L	L	8 dB
H	L	L	L	L	L	L	16 dB
H	H	H	H	H	H	H	31.75 dB

**Table 10. Serial Address Word Truth Table**

Address Word								Address Setting
A7 (MSB)	A6	A5	A4	A3	A2	A1	A0	
X	X	X	X	X	L	L	L	000
X	X	X	X	X	L	L	H	001
X	X	X	X	X	L	H	L	010
X	X	X	X	X	L	H	H	011
X	X	X	X	X	H	L	L	100
X	X	X	X	X	H	L	H	101
X	X	X	X	X	H	H	L	110
X	X	X	X	X	H	H	H	111

**Table 11. Serial Attenuation Word Truth Table**

Attenuation Word								Attenuation Setting RF1-RF2
D7	D6	D5	D4	D3	D2	D1	D0 (LSB)	
L	L	L	L	L	L	L	L	Reference I.L.
L	L	L	L	L	L	L	H	0.25 dB
L	L	L	L	L	L	H	L	0.5 dB
L	L	L	L	L	H	L	L	1 dB
L	L	L	L	H	L	L	L	2 dB
L	L	L	H	L	L	L	L	4 dB
L	L	H	L	L	L	L	L	8 dB
L	H	L	L	L	L	L	L	16 dB
L	H	H	H	H	H	H	H	31.75 dB

**Table 12. Serial-Addressable Register Map**

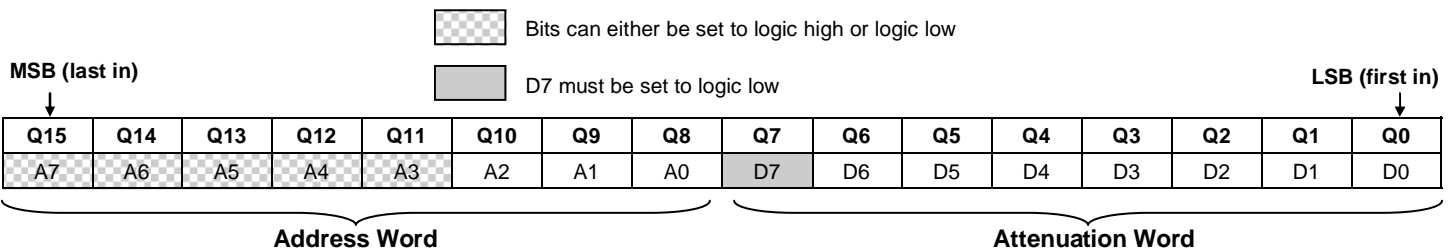

Attenuation Word is derived directly from the attenuation value. For example, to program the 18.25 dB state at address 3:

Address word: XXXXX011  
 Attenuation Word: Multiply by 4 and convert to binary  $\rightarrow 4 * 18.25 \text{ dB} \rightarrow 73 \rightarrow 01001001$   
 Serial Input: XXXXX01101001001

## Programming Options

### Parallel/Serial Selection

Either a parallel or serial-addressable interface can be used to control the PE43703. The  $\bar{P}/S$  bit provides this selection, with  $\bar{P}/S=LOW$  selecting the parallel interface and  $\bar{P}/S=HIGH$  selecting the serial-addressable interface.

### Parallel Mode Interface

The parallel interface consists of seven CMOS-compatible control lines that select the desired attenuation state, as shown in *Table 9*.

The parallel interface timing requirements are defined by *Fig. 30* (Parallel Interface Timing Diagram), *Table 9* (Parallel Interface AC Characteristics), and switching speed (*Table 1*).

For *latched*-parallel programming the Latch Enable (LE) should be held LOW while changing attenuation state control values, then pulse LE HIGH to LOW (*per Fig. 30*) to latch new attenuation state into device.

For *direct* parallel programming, the Latch Enable (LE) line should be pulled HIGH. Changing attenuation state control values will change device state to new attenuation. Direct mode is ideal for manual control of the device (using hardware, switches, or jumpers).

### Serial-Addressable Interface

The serial-addressable interface is a 16-bit serial-in, parallel-out shift register buffered by a transparent latch. The 16-bits make up two words comprised of 8-bits each. The first word is the Attenuation Word, which controls the state of the DSA. The second word is the Address Word, which is compared to the static (or programmed) logical states of the A0, A1 and A2 digital inputs. If there is an address match, the DSA changes state; otherwise its current state will remain unchanged. *Fig. 29* illustrates an example timing diagram for programming a state. It is required that all parallel control inputs be grounded when the DSA is used in serial-addressable mode.

The serial-addressable interface is controlled using three CMOS-compatible signals: Serial-In (SI), Clock (CLK), and Latch Enable (LE). The SI and CLK inputs allow data to be serially entered into the

shift register. Serial data is clocked in LSB first, beginning with the Attenuation Word.

The shift register must be loaded while LE is held LOW to prevent the attenuator value from changing as data is entered. The LE input should then be toggled HIGH and brought LOW again, latching the new data into the DSA. Address Word and Attenuation Word truth tables are listed in *Table 10* & *Table 11*, respectively. A programming example of the serial-addressable register is illustrated in *Table 12*. The serial-addressable timing diagram is illustrated in *Fig. 29*.

### Power-up Control Settings

The PE43703 will always initialize to the maximum attenuation setting (31.75 dB) on power-up for both the serial-addressable and latched-parallel modes of operation and will remain in this setting until the user latches in the next programming word. In direct-parallel mode, the DSA can be preset to any state within the 31.75 dB range by pre-setting the parallel control pins prior to power-up. In this mode, there is a 400- $\mu$ s delay between the time the DSA is powered-up to the time the desired state is set. During this power-up delay, the device attenuates to the maximum attenuation setting (31.75 dB) before defaulting to the user defined state. If the control pins are left floating in this mode during power-up, the device will default to the minimum attenuation setting (insertion loss state).

Dynamic operation between serial-addressable and parallel programming modes is possible.

If the DSA powers up in serial-addressable mode ( $\bar{P}/S = HIGH$ ), all the parallel control inputs DI[6:0] must be set to logic low. Prior to toggling to parallel mode, the DSA *must* be programmed serially to ensure D[7] is set to logic low.

If the DSA powers up in either latched or direct-parallel mode, all parallel pins DI[6:0] must be set to logic low prior to toggling to serial-addressable mode ( $\bar{P}/S = HIGH$ ), and *held* low until the DSA has been programmed serially to ensure bit D[7] is set to logic low.

The sequencing is only required once on power-up. Once completed, the DSA may be toggled between serial-addressable and parallel programming modes at will.

Figure 29. Serial-Addressable Timing Diagram

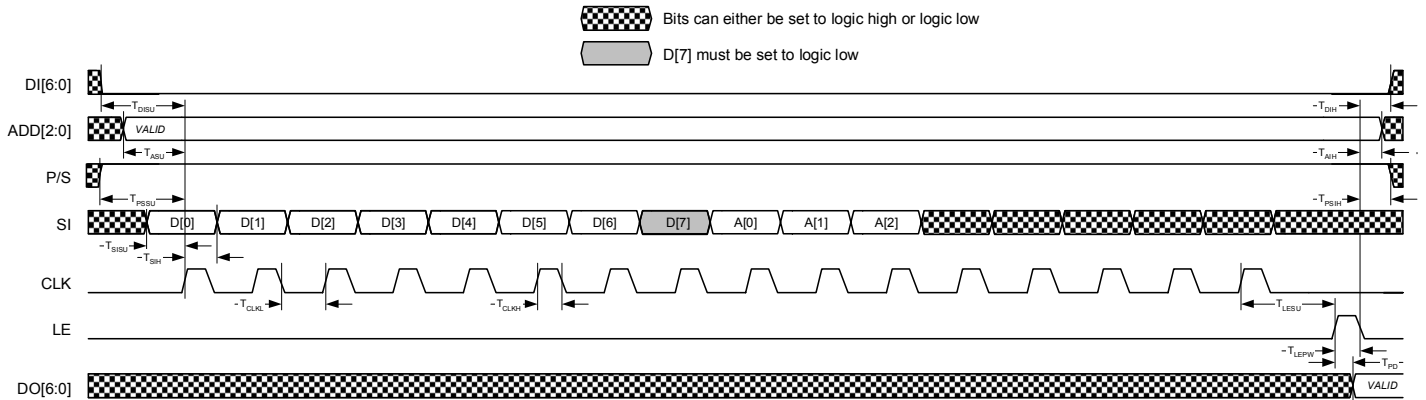

Figure 30. Latched-Parallel/Direct-Parallel Timing Diagram

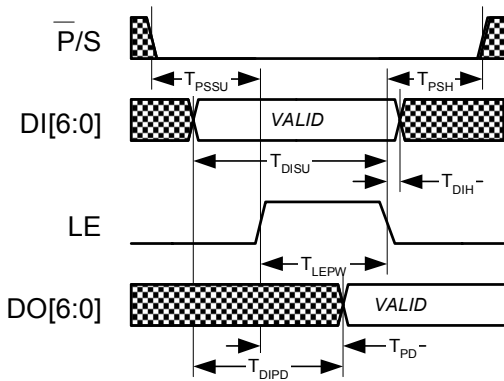

Table 13. Serial-Addressable Interface AC Characteristics

$V_{DD} = 3.3$  or  $5.0$  V,  $-40^{\circ}C < T_A < 85^{\circ}C$ , unless otherwise specified

Symbol	Parameter	Min	Max	Unit
$F_{CLK}$	Serial clock frequency	-	10	MHz
$T_{CLKH}$	Serial clock HIGH time	30	-	ns
$T_{CLKL}$	Serial clock LOW time	30	-	ns
$T_{LESU}$	Last serial clock rising edge setup time to Latch Enable rising edge	10	-	ns
$T_{LEPW}$	Latch Enable min. pulse width	30	-	ns
$T_{SISU}$	Serial data setup time	10	-	ns
$T_{SIH}$	Serial data hold time	10	-	ns
$T_{DISU}$	Parallel data setup time	100	-	ns
$T_{DIH}$	Parallel data hold time	100	-	ns
$T_{ASU}$	Address setup time	100	-	ns
$T_{AH}$	Address hold time	100	-	ns
$T_{PSSU}$	Parallel/Serial setup time	100	-	ns
$T_{PSH}$	Parallel/Serial hold time	100	-	ns
$T_{PD}$	Digital register delay (internal)	-	10	ns

Table 14. Parallel and Direct Interface AC Characteristics

$V_{DD} = 3.3$  or  $5.0$  V,  $-40^{\circ}C < T_A < 85^{\circ}C$ , unless otherwise specified

Symbol	Parameter	Min	Max	Unit
$T_{LEPW}$	Latch Enable minimum pulse width	30	-	ns
$T_{DISU}$	Parallel data setup time	100	-	ns
$T_{DIH}$	Parallel data hold time	100	-	ns
$T_{PSSU}$	Parallel/Serial setup time	100	-	ns
$T_{PSIH}$	Parallel/Serial hold time	100	-	ns
$T_{PD}$	Digital register delay (internal)	-	10	ns
$T_{DIPD}$	Digital register delay (internal, direct mode only)	-	5	ns

## Evaluation Kit

The Digital Attenuator Evaluation Kit board was designed to ease customer evaluation of the PE43703 Digital Step Attenuator.

### *Direct-Parallel Programming Procedure*

For automated direct-parallel programming, connect the test harness provided with the EVK from the parallel port of the PC to the J1 & Serial header pin and set the D0-D6 SP3T switches to the 'MIDDLE' toggle position. Position the Parallel/Serial ( $\bar{P}/S$ ) select switch to the Parallel (or left) position. The evaluation software is written to operate the DSA in either Parallel or Serial-Addressable Mode. Ensure that the software is set to program in *Direct-Parallel* mode. Using the software, enable or disable each setting to the desired attenuation state. The software automatically programs the DSA each time an attenuation state is enabled or disabled.

For manual direct-parallel programming, disconnect the test harness provided with the EVK from the J1 and Serial header pins. Position the Parallel/Serial ( $\bar{P}/S$ ) select switch to the Parallel (or left) position. The LE pin on the Serial header must be tied to  $V_{DD}$ . Switches D0-D6 are SP3T switches which enable the user to manually program the parallel bits. When any input D0-D6 is toggled 'UP', logic high is presented to the parallel input. When toggled 'DOWN', logic low is presented to the parallel input. Setting D0-D6 to the 'MIDDLE' toggle position presents an OPEN, which forces an on-chip logic low. Table 9 depicts the parallel programming truth table and Fig. 30 illustrates the parallel programming timing diagram.

### *Latched-Parallel Programming Procedure*

For automated latched-parallel programming, the procedure is identical to the direct-parallel method. The user only must ensure that *Latched-Parallel* is selected in the software.

For manual latched-parallel programming, the procedure is identical to direct-parallel except now the LE pin on the Serial header must be logic low as the parallel bits are applied. The user must then pulse LE from 0V to  $V_{DD}$  and back to 0V to latch the programming word into the DSA. LE must be logic low prior to programming the next word.

**Figure 31. Evaluation Board Layout**

Peregrine Specification 101-0312

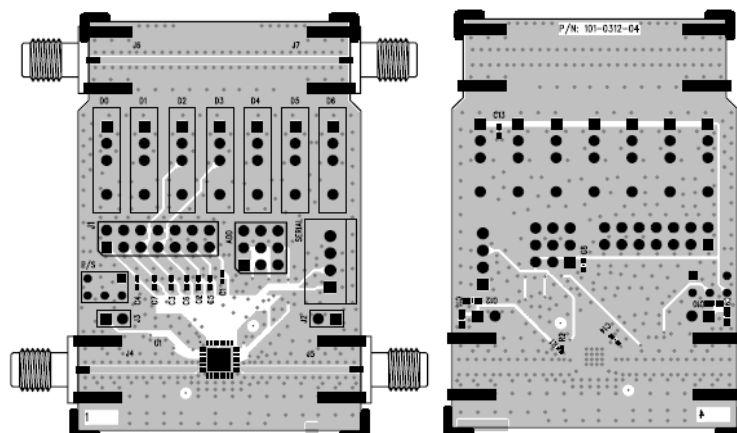

Note: Reference Fig. 32 for Evaluation Board Schematic

### *Serial-Addressable Programming Procedure*

Position the Parallel/Serial ( $\bar{P}/S$ ) select switch to the Serial (or right) position. Prior to programming, the user must define an address setting using the ADD header pin. Jump the middle pins on the ADD header A0-A2 (or lower) row of pins to set logic high, or jump the middle pins to the upper row of pins to set logic low. If the ADD pins are left open, then 000 become the default address. The evaluation software is written to operate the DSA in either Parallel or Serial-Addressable Mode. Ensure that the software is set to program in *Serial-Addressable* mode. Using the software, enable or disable each setting to the desired attenuation state. The software automatically programs the DSA each time an attenuation state is enabled or disabled.

**Figure 32. Evaluation Board Schematic**  
Peregrine Specification 102-0381

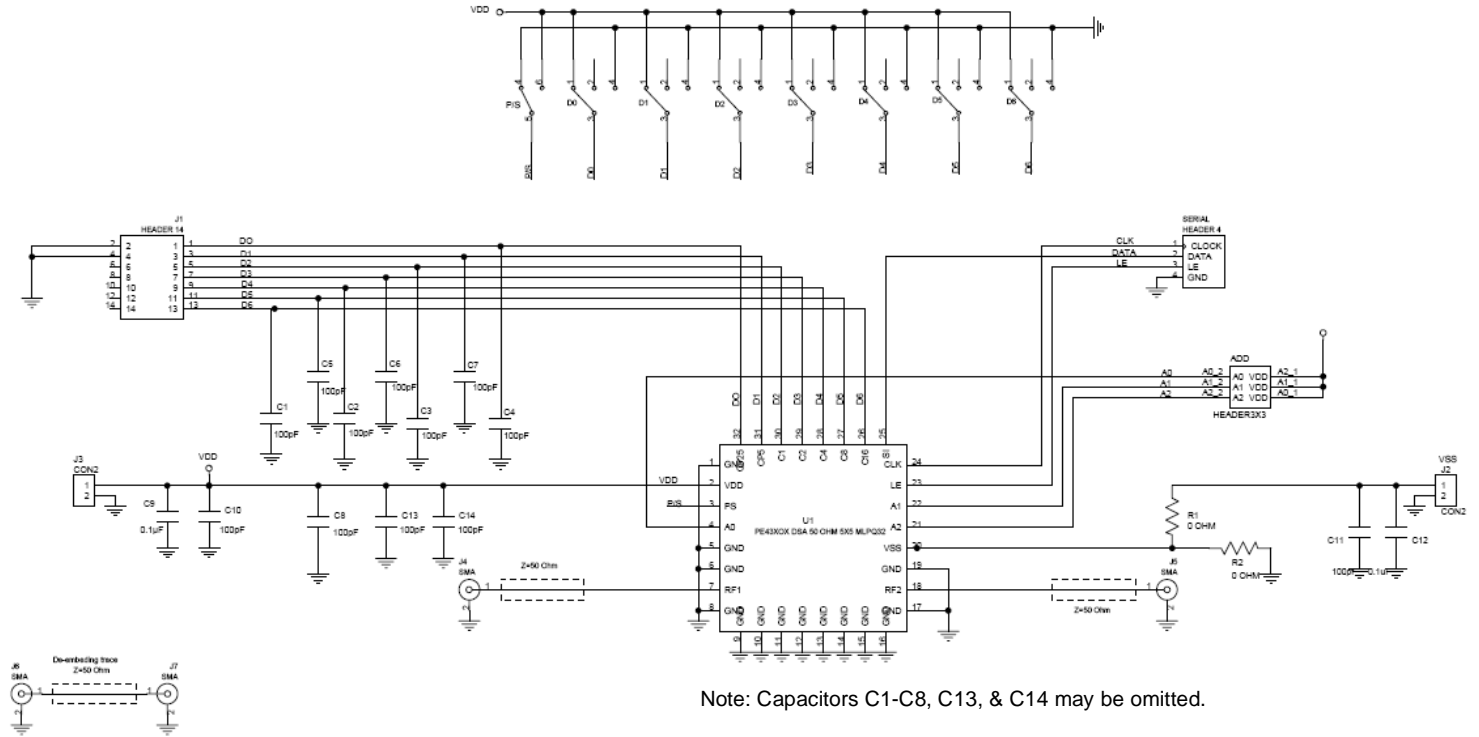

**Figure 33. Package Drawing**

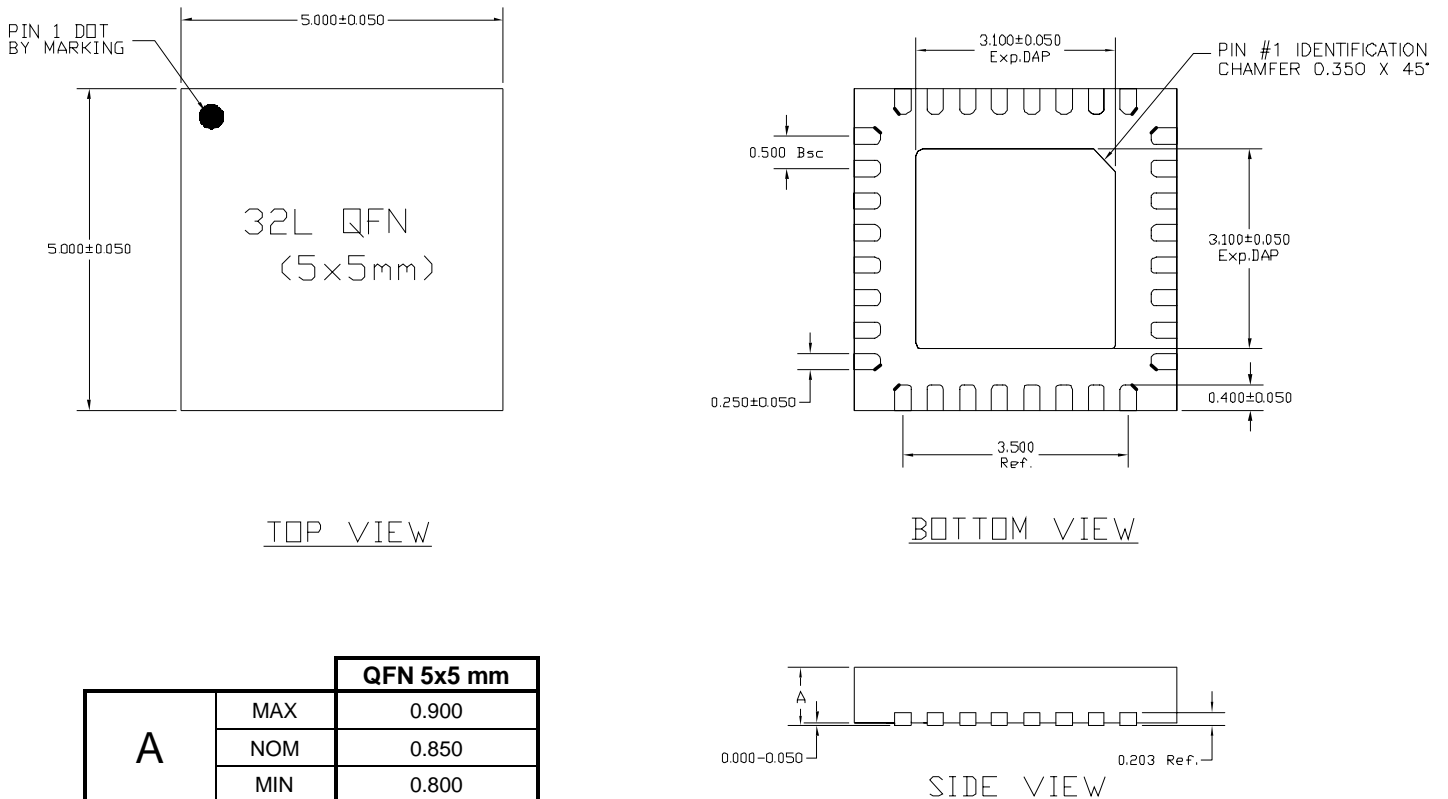
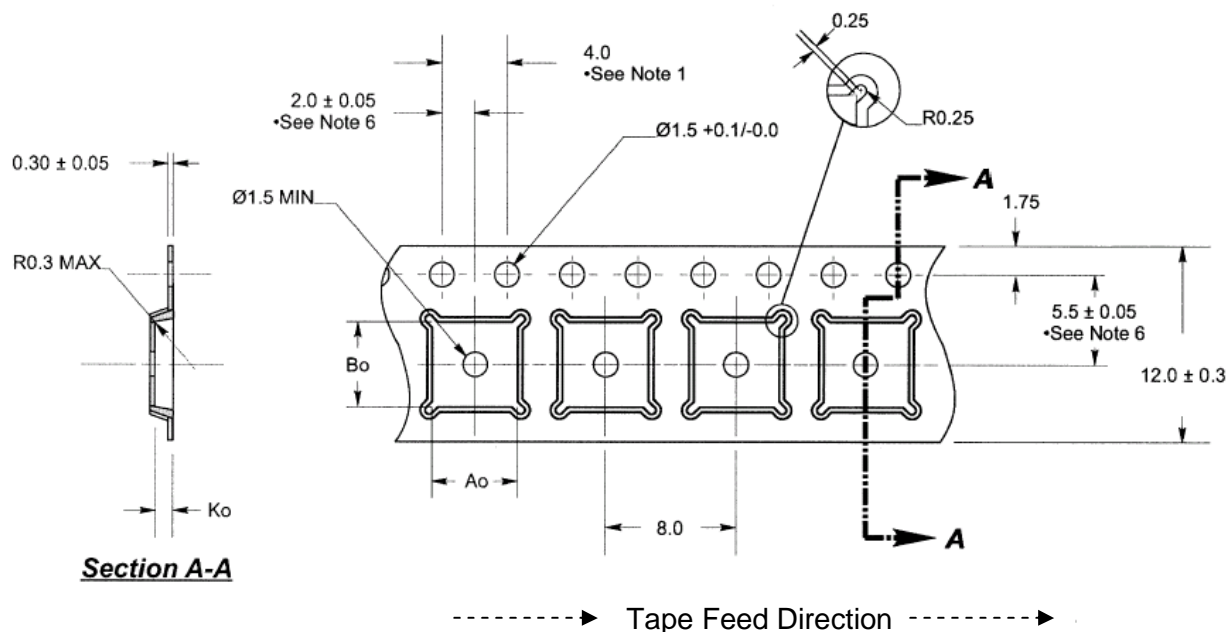

Figure 34. Tape and Reel Drawing



Notes:

1. 10 sprocket hole pitch cumulative tolerance  $\pm 0.02$ .
2. Camber not to exceed 1mm in 100mm.
3. Material: PS + C.
4. Ao and Bo measured as indicated.
5. Ko measured from a plane on the inside bottom of the pocket to the top surface of the carrier.
6. Pocket position relative to sprocket hole measured as true position of pocket, not pocket hole.

Ao = 5.25 mm  
Bo = 5.25 mm  
Ko = 1.1 mm

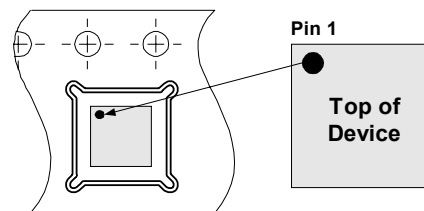

Device Orientation in Tape

Figure 35. Marking Specifications

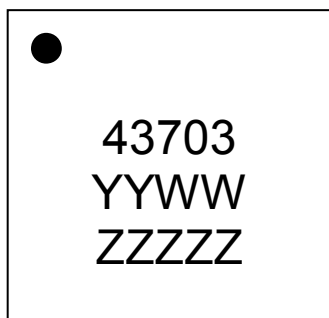

YYWW = Date Code  
ZZZZZ = Last five digits of Lot Number

Table 15. Ordering Information

Order Code	Part Marking	Description	Package	Shipping Method
PE43703MLI	43703	PE43703 G - 32QFN 5x5mm-75A	Green 32-lead 5x5mm QFN	Bulk or tape cut from reel
PE43703MLI-Z	43703	PE43703 G - 32QFN 5x5mm-3000C	Green 32-lead 5x5mm QFN	3000 units / T&R
EK43703-01	43703	PE43703 G - 32QFN 5x5mm-EK	Evaluation Kit	1 / Box

## Sales Offices

### *The Americas*

#### **Peregrine Semiconductor Corporation**

9380 Carroll Park Drive  
San Diego, CA 92121  
Tel: 858-731-9400  
Fax: 858-731-9499

### *Europe*

#### **Peregrine Semiconductor Europe**

Bâtiment Maine  
13-15 rue des Quatre Vents  
F-92380 Garches, France  
Tel: +33-1-4741-9173  
Fax : +33-1-4741-9173

### **High-Reliability and Defense Products**

#### *Americas*

San Diego, CA, USA  
Phone: 858-731-9475  
Fax: 848-731-9499

#### *Europe/Asia-Pacific*

Aix-En-Provence Cedex 3, France  
Phone: +33-4-4239-3361  
Fax: +33-4-4239-7227

For a list of representatives in your area, please refer to our Web site at: [www.psemi.com](http://www.psemi.com)

## Data Sheet Identification

### **Advance Information**

The product is in a formative or design stage. The data sheet contains design target specifications for product development. Specifications and features may change in any manner without notice.

### **Preliminary Specification**

The data sheet contains preliminary data. Additional data may be added at a later date. Peregrine reserves the right to change specifications at any time without notice in order to supply the best possible product.

### **Product Specification**

The data sheet contains final data. In the event Peregrine decides to change the specifications, Peregrine will notify customers of the intended changes by issuing a CNF (Customer Notification Form).

### **Peregrine Semiconductor, Asia Pacific (APAC)**

Shanghai, 200040, P.R. China  
Tel: +86-21-5836-8276  
Fax: +86-21-5836-7652

### **Peregrine Semiconductor, Korea**

#B-2607, Kolon Tripolis, 210  
Geumgok-dong, Bundang-gu, Seongnam-si  
Gyeonggi-do, 463-943 South Korea  
Tel: +82-31-728-3939  
Fax: +82-31-728-3940

### **Peregrine Semiconductor K.K., Japan**

Teikoku Hotel Tower 10B-6  
1-1-1 Uchisaiwai-cho, Chiyoda-ku  
Tokyo 100-0011 Japan  
Tel: +81-3-3502-5211  
Fax: +81-3-3502-5213

The information in this data sheet is believed to be reliable. However, Peregrine assumes no liability for the use of this information. Use shall be entirely at the user's own risk.

No patent rights or licenses to any circuits described in this data sheet are implied or granted to any third party.

Peregrine's products are not designed or intended for use in devices or systems intended for surgical implant, or in other applications intended to support or sustain life, or in any application in which the failure of the Peregrine product could create a situation in which personal injury or death might occur. Peregrine assumes no liability for damages, including consequential or incidental damages, arising out of the use of its products in such applications.

The Peregrine name, logo, and UTSi are registered trademarks and UltraCMOS, HaRP, MultiSwitch and DuNE are trademarks of Peregrine Semiconductor Corp.