

Features

- On-Chip Hall Plate
- Operating Voltage: 4V~28V
- Output Current: 400mA (Continuous, 25°C)
- Reverse Protection Diode Only for Chip Reverse Power Connecting (Note 1)
- Output Protection Zener Breakdown Vz = 62V (Typ.)
- Lead Free package: SIP-4L
- SIP-4L: Available in "Green" Molding Compound (No Br, Sb)
- Lead Free Finish/ RoHS Compliant (Note 2)

General Description

AH266 is an integrated Hall sensor with output drivers designed for electronic commutation of brush-less DC motor applications. The device includes an on-chip Hall voltage generator for magnetic sensing, a comparator that amplifies the Hall voltage, a Schmitt trigger to provide switching hysteresis for noise rejection, and complementary Darlington open-collector drivers for sinking large current loads. An internal band-gap regulator is used to provide temperature compensated supply voltage for internal circuits and allows a wide operating supply range.





If a magnetic flux density (B) is larger than operation point (Bop), DO will turn on (low) and DOB will turn off (high). The output state is latched prior to reaching release point (Brp). If B < Brp, DO will turn off and DOB will turn on. AH266 is rated for operation over temperature range from -20°C to 85°C and voltage range from 4V to 28V. The devices are available in low cost die forms or rugged 4 pin SIP packages.

Applications

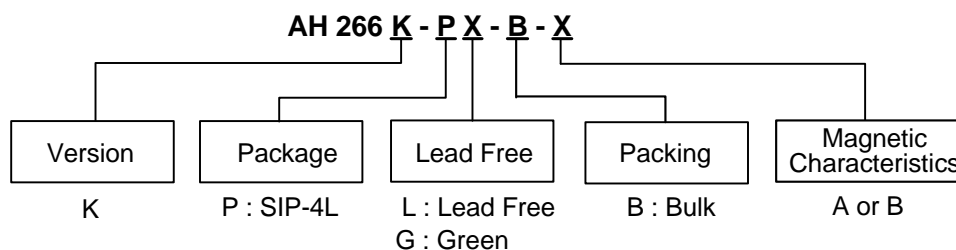
- Dual-Coil Brush-Less DC Motor
- Dual-Coil Brush-Less DC Fan
- Revolution Counting
- Speed Measurement

Ordering Information



Device	Package Code	Packaging (Note 3)	Bulk		Magnetic Characteristics
			Quantity	Part Number Suffix	
 AH266K-PL-B-A	P	SIP-4L	1000	-B	A
 AH266K-PL-B-B	P	SIP-4L	1000	-B	B
 AH266K-PG-B-A	P	SIP-4L	1000	-B	A
 AH266K-PG-B-B	P	SIP-4L	1000	-B	B

- Notes:
1. Protection diode only exists at power pin (1, 4) output, not including pin (2, 3).
 2. EU Directive 2002/95/EC (RoHS). All applicable RoHS exemptions applied. Please visit our website at http://www.diodes.com/products/lead_free.html.
 3. Pad layout as shown on Diodes Inc. suggested pad layout document AP02001, which can be found on our website at <http://www.diodes.com/datasheets/ap02001.pdf>.

Pin Assignment

(Top View)

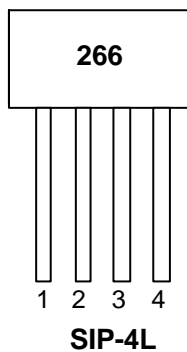

Pin Descriptions

Pin Name	P/I/O	Pin #	Description
V _{CC}	P	1	Power Supply Input
DO	O	2	Output Pin
DOB	O	3	Output Pin
GND	P	4	Ground

Block Diagram

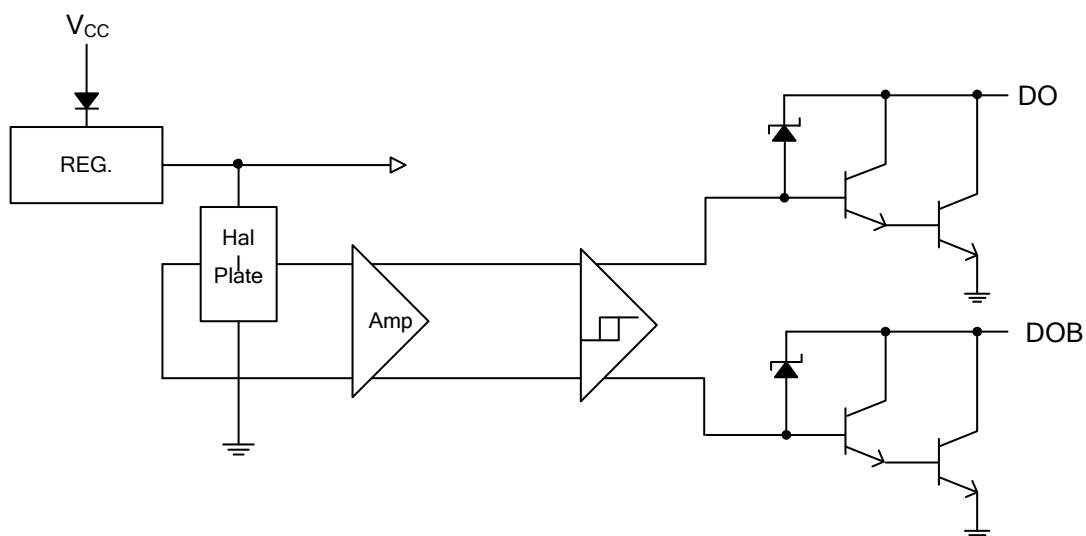

Typical Application Circuit

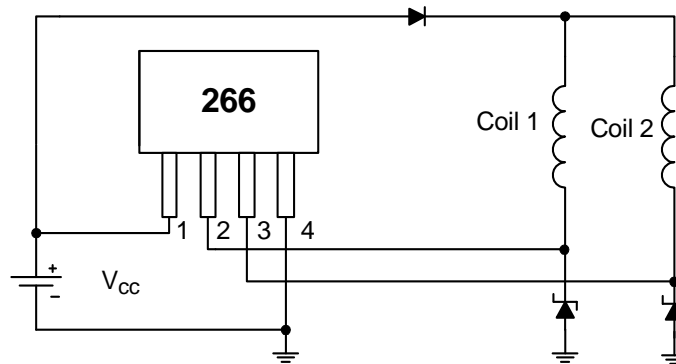

Brush-Less DC Fan

Absolute Maximum Ratings (T_A = 25°C)

Symbol	Parameter	Rating	Unit
V _{CC}	Supply Voltage	28	V
V _{out (off)}	Output "OFF" Voltage	28	V
I _{o (con)}	Output "ON" Current	400 (Note 5)	mA
I _{o (hold)}		500	mA
I _{o (peak)}		700	mA
B	Magnetic Flux Density	Unlimited	Gauss
T _{ST}	Storage Temperature Range	-65 ~ +150	°C
P _D	Power Dissipation (Note 6)	550	mW
θ _{JC}	Thermal Resistance Junction-to-Case	227	°C/W

Recommended Operating Conditions

Symbol	Characteristic	Conditions	Min	Max	Unit
V _{CC}	Supply Voltage	Operating	4	28	V
T _A	Operating Ambient Temperature (Note 7)	Operating	-20	85	°C

- Notes:
- This application circuit can't protect reverse coil current if power is connecting reverse.
 - I_{o (con)} is 150 mA at 85°C.
 - See **Performance Characteristics** for other conditions.
 - Shall not exceed P_D and Safety Operation Area.

Electrical Characteristics (T_A = 25°C)

Symbol	Characteristic	Conditions	Min	Typ.	Max	Unit
V _Z	Output Zener Breakdown	Output Turn off	54	62	70	V
V _{ce (SAT)}	Output Saturation Voltage	V _{CC} = 24V, I _C = 400mA	—	1.1	1.5	V
I _{ceX}	Output Leakage Current	V _{ce} = 24V, V _{CC} = 24V	—	< 0.1	10	μA
I _{CC}	Supply Current	V _{CC} = 24V, Output Open	—	5	10	mA
t _r	Output Rise Time	V _{CC} = 24V, R _L = 820Ω, C _L = 20pF	—	1.0	5	μs
t _f	Output Falling Time	V _{CC} = 24V, R _L = 820Ω, C _L = 20pF	—	1.0	1.5	μs
Δt	Switch Time Differential	V _{CC} = 24V, R _L = 820Ω, C _L = 20pF	—	3.0	10	μs

Test Circuit

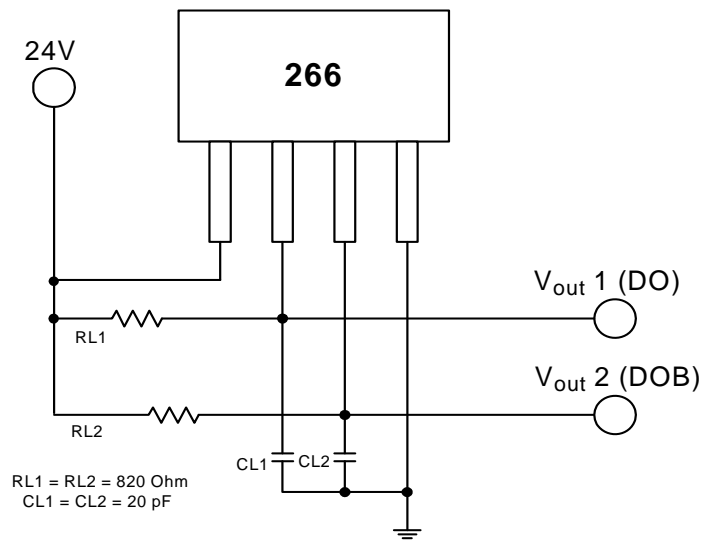

Magnetic Characteristics $(T_A = +25^\circ\text{C})$

A grade

(1mT = 10 Gauss)

Symbol	Characteristic	Min	Typ.	Max	Unit
Bop	Operation Point	10	-	70	Gauss
Brp	Release Point	-70	-	-10	Gauss
Bhy	Hysteresis	-	80	-	Gauss

B grade

Symbol	Characteristic	Min	Typ.	Max	Unit
Bop	Operation Point	-	-	100	Gauss
Brp	Release Point	-100	-	-	Gauss
Bhy	Hysteresis	-	80	-	Gauss

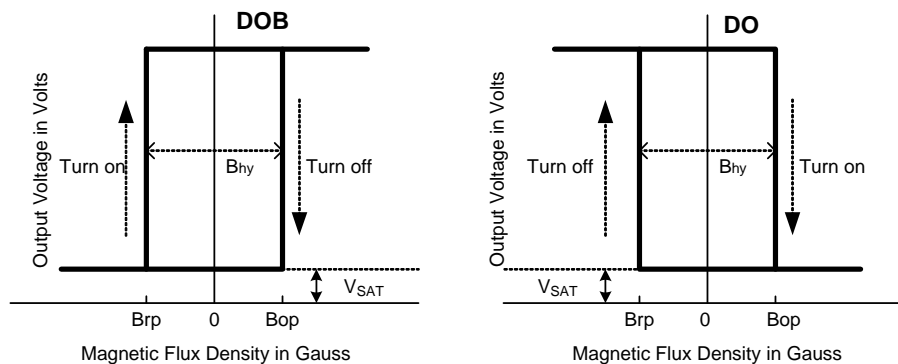

Performance Characteristics

T_A (°C)	25	50	60	70	80	85	90	95	100
P_D (mW)	550	440	396	352	308	286	264	242	220
T_A (°C)	105	110	115	120	125	130	135	140	150
P_D (mW)	198	176	154	132	110	88	66	44	0

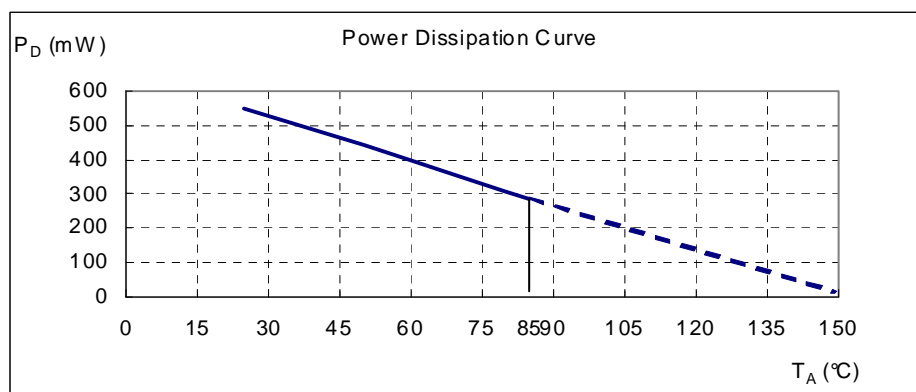

Operation Characteristics

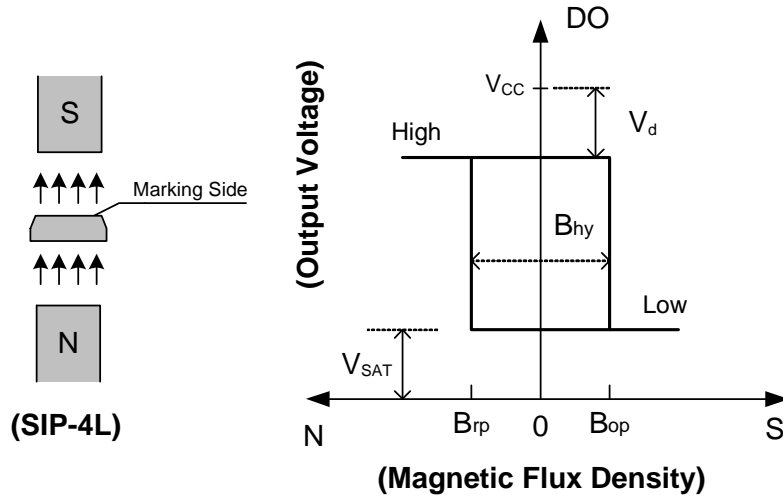

Marking Information

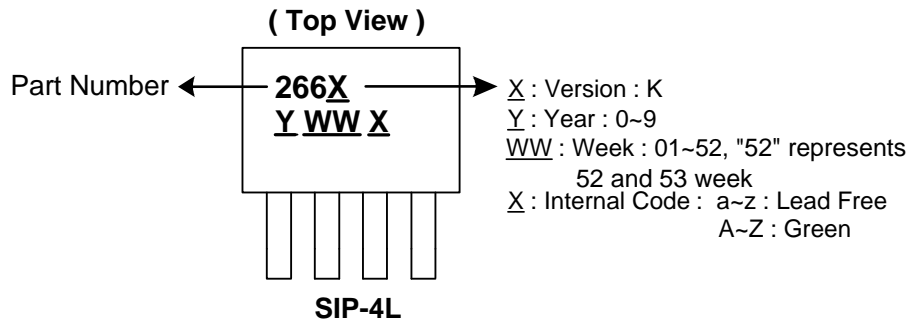

Package Information (All Dimensions in mm)

(1) Package type: SIP-4L

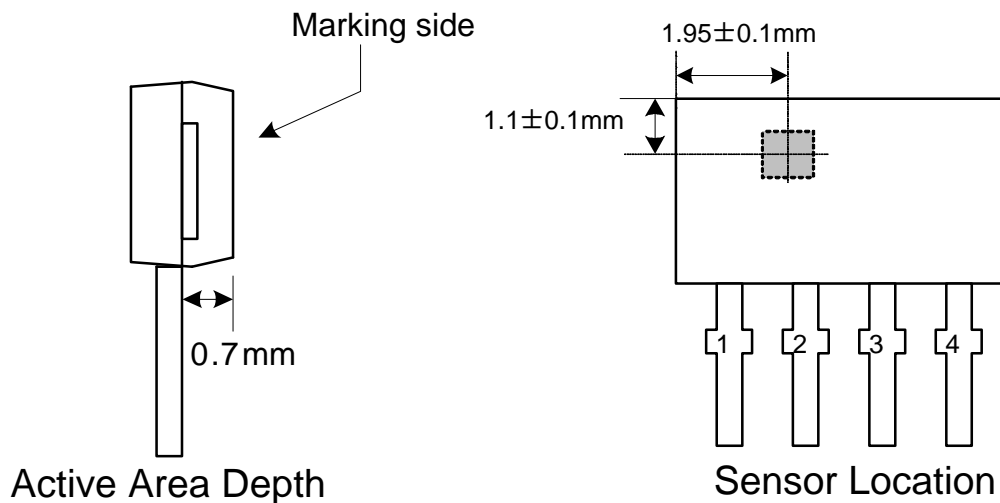

Package Dimension

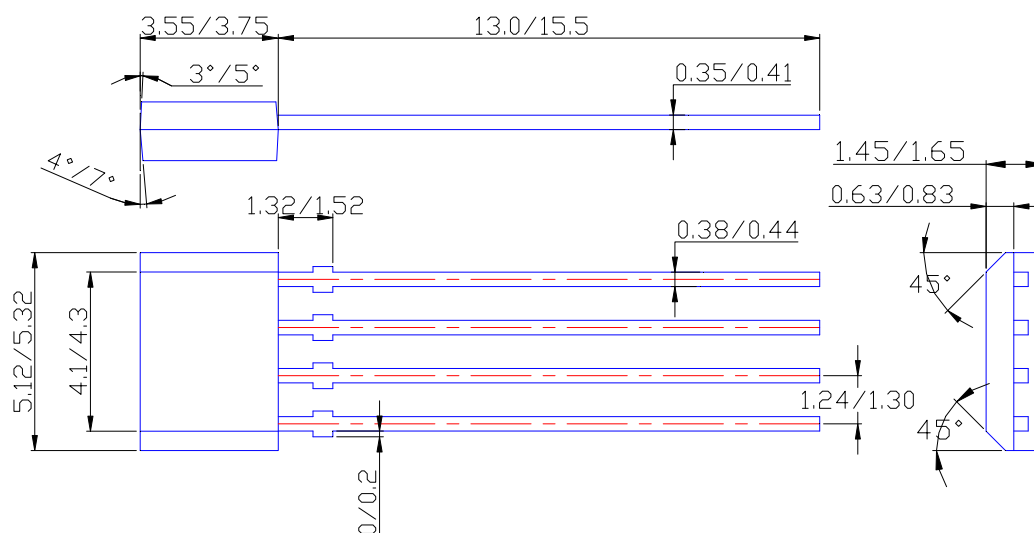

IMPORTANT NOTICE

Diodes Incorporated and its subsidiaries reserve the right to make modifications, enhancements, improvements, corrections or other changes without further notice to any product herein. Diodes Incorporated does not assume any liability arising out of the application or use of any product described herein; neither does it convey any license under its patent rights, nor the rights of others. The user of products in such applications shall assume all risks of such use and will agree to hold Diodes Incorporated and all the companies whose products are represented on our website, harmless against all damages.

LIFE SUPPORT

Diodes Incorporated products are not authorized for use as critical components in life support devices or systems without the expressed written approval of the President of Diodes Incorporated.