

40V COMPLEMENTARY PAIR ENHANCEMENT MODE MOSFET

Product Summary

Device	V _{(BR)DSS}	R _{DS(on)} max	I _D max (A) T _A = 25°C (Notes 3 & 5)
Q1	40V	25mΩ @ V _{GS} = 10V	7.5
		40mΩ @ V _{GS} = 4.5V	6.2
Q2	-40V	25mΩ @ V _{GS} = -10V	-7.3
		45mΩ @ V _{GS} = -4.5V	-5.7

Description and Applications

This MOSFET has been designed to ensure that R_{DS(on)} of N and P channel FET are matched to minimize losses in both arms of the bridge. The DMC4040SSD is optimized for use in 3 phases brushless DC motor circuits (BLDC), CCFL backlighting.

- 3 phases BLDC motor
- CCFL backlighting

Features and Benefits

- Matched N & P R_{DS(on)} - Minimizes power losses
- Fast switching – Minimizes switching losses
- Dual device – Reduces PCB area
- "Green" component and RoHS compliant (Note 1)
- Qualified to AEC-Q101 Standards for High Reliability

Mechanical Data

- Case: SO-8
- Case Material: Molded Plastic, "Green" Molding Compound. UL Flammability Classification Rating 94V-0 (Note 1)
- Moisture Sensitivity: Level 1 per J-STD-020
- Terminals: Finish - Matte Tin annealed over Copper lead frame. Solderable per MIL-STD-202, Method 208
- Weight: 0.074 grams (approximate)

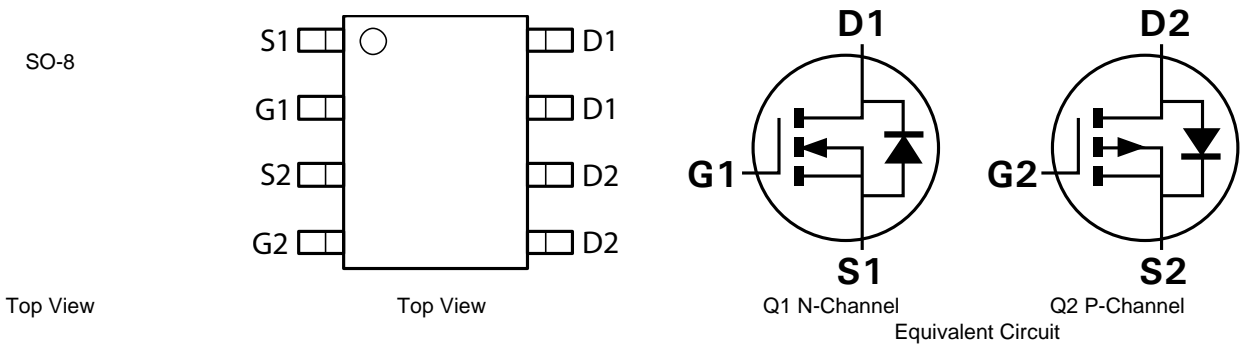

Ordering Information (Note 1)

Product	Marking	Reel size (inches)	Tape width (mm)	Quantity per reel
DMC4040SSD-13	C4040SD	13	12	2,500

Note: 1. Diodes, Inc. defines "Green" products as those which are RoHS compliant and contain no halogens or antimony compounds; further information about Diodes Inc.'s "Green" Policy can be found on our website. For packaging details, go to our website.

Marking Information

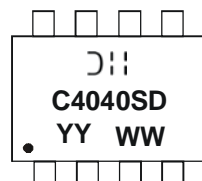

D = Manufacturer's Marking
 C4040SD = Product Type Marking Code
 YYWW = Date Code Marking
 YY = Year (ex: 10 = 2010)
 WW = Week (01 - 53)

Maximum Ratings @ $T_A = 25^\circ\text{C}$ unless otherwise specified

Characteristic			Symbol	N-Channel - Q1	P-Channel - Q2	Unit
Drain-Source Voltage			V_{DSS}	40	-40	V
Gate-Source Voltage			V_{GSS}	± 20	± 20	
Continuous Drain Current	$V_{GS} = 10\text{V}$	(Notes 3 & 5)	I_D	7.5	-7.5	A
		$T_A = 70^\circ\text{C}$ (Notes 3 & 5)		5.8	-5.8	
		(Notes 2 & 5)		5.7	-5.7	
		(Notes 2 & 6)		6.8	-6.8	
Pulsed Drain Current	$V_{GS} = 10\text{V}$	(Notes 4 & 5)	I_{DM}	29.0	-29.0	
Continuous Source Current (Body diode)			(Notes 3 & 5)	I_S	3.0	
Pulsed Source Current (Body diode)			(Notes 4 & 5)	I_{SM}	29.0	-29.0

Thermal Characteristics @ $T_A = 25^\circ\text{C}$ unless otherwise specified

Characteristic		Symbol	N-Channel - Q1	P-Channel - Q2	Unit
Power Dissipation Linear Derating Factor	(Notes 2 & 5)	P_D	1.25		W mW/ $^\circ\text{C}$
			10		
	(Notes 2 & 6)		1.8		
			14.3		
Thermal Resistance, Junction to Ambient	(Notes 3 & 5)	$R_{\theta JA}$	2.14		$^\circ\text{C}/\text{W}$
			17.2		
	(Notes 2 & 5)		100		
	(Notes 2 & 6)		70		
Thermal Resistance, Junction to Lead	(Notes 3 & 5)	$R_{\theta JL}$	58		
	(Notes 5 & 7)		51		
Operating and Storage Temperature Range		T_J, T_{STG}	-55 to +150		$^\circ\text{C}$

- Notes:
- For a device surface mounted on 25mm x 25mm x 1.6mm FR4 PCB with high coverage of single sided 1oz copper, in still air conditions; the device is measured when operating in a steady-state condition.
 - Same as note (2), except the device is measured at $t \leq 10$ sec.
 - Same as note (2), except the device is pulsed with $D = 0.02$ and pulse width 300 μs .
 - For a dual device with one active die.
 - For a device with two active die running at equal power.
 - Thermal resistance from junction to solder-point (at the end of the drain lead).

Thermal Characteristics

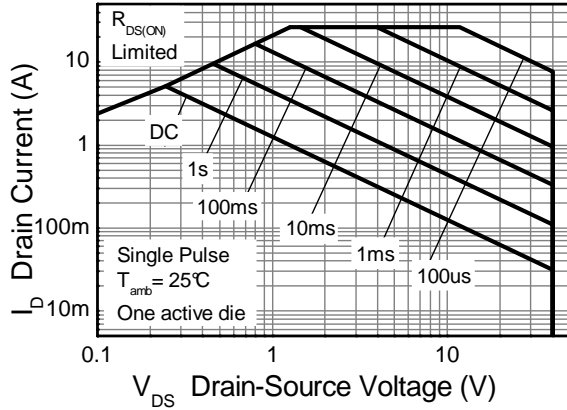

N-channel Safe Operating Area

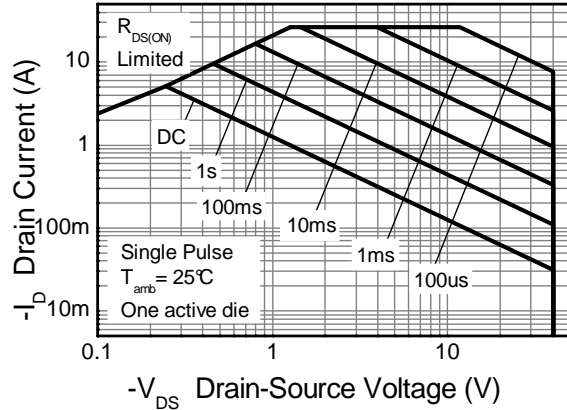

P-channel Safe Operating Area

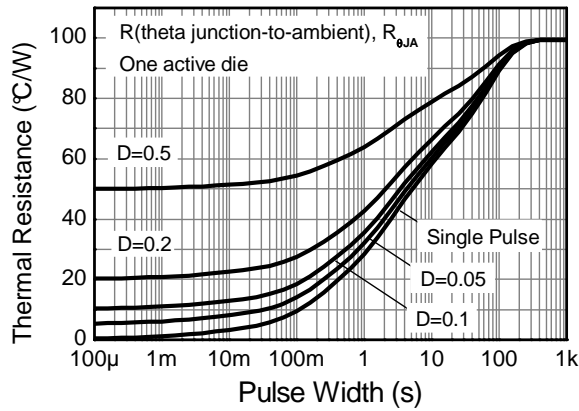

Transient Thermal Impedance

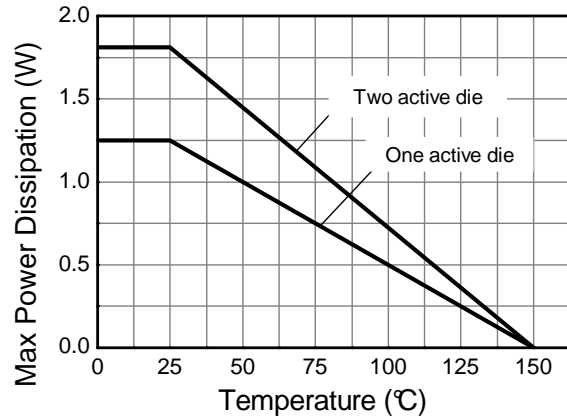

Derating Curve

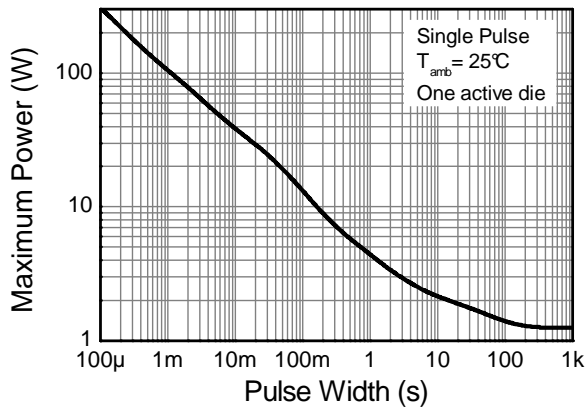

Pulse Power Dissipation

Electrical Characteristics – Q1 N-CHANNEL @T_A = 25°C unless otherwise specified

Characteristic	Symbol	Min	Typ	Max	Unit	Test Condition
OFF CHARACTERISTICS						
Drain-Source Breakdown Voltage	BV _{DSS}	40	—	—	V	I _D = 250μA, V _{GS} = 0V
Zero Gate Voltage Drain Current	I _{DSS}	—	—	1.0	μA	V _{DS} = 40V, V _{GS} = 0V
Gate-Source Leakage	I _{GSS}	—	—	±100	nA	V _{GS} = ±20V, V _{DS} = 0V
ON CHARACTERISTICS						
Gate Threshold Voltage	V _{GS(th)}	0.8	1.3	1.8	V	I _D = 250μA, V _{DS} = V _{GS}
Static Drain-Source On-Resistance (Note 8)	R _{DS(on)}	—	0.013	0.025	Ω	V _{GS} = 10V, I _D = 3A
			0.028	0.040		V _{GS} = 4.5V, I _D = 3A
Forward Transconductance (Notes 8 & 9)	g _{fs}	—	12.6	—	S	V _{DS} = 5V, I _D = 3A
Diode Forward Voltage (Note 8)	V _{SD}	—	0.7	1.0	V	I _S = 1A, V _{GS} = 0V
DYNAMIC CHARACTERISTICS (Note 9)						
Input Capacitance	C _{iss}	—	1790	—	pF	V _{DS} = 20V, V _{GS} = 0V f = 1MHz
Output Capacitance	C _{oss}	—	160	—		
Reverse Transfer Capacitance	C _{rss}	—	120	—		
Gate Resistance	R _g	—	1.03	—	Ω	V _{DS} = 0V, V _{GS} = 0V, f = 1MHz
Total Gate Charge (Note 10)	Q _g	—	16.0	—	nC	V _{GS} = 4.5V V _{GS} = 10V V _{DS} = 20V I _D = 3A
Total Gate Charge (Note 10)	Q _g	—	37.6	—		
Gate-Source Charge (Note 10)	Q _{gs}	—	7.8	—		
Gate-Drain Charge (Note 10)	Q _{gd}	—	6.6	—		
Turn-On Delay Time (Note 10)	t _{D(on)}	—	8.1	—	ns	V _{DD} = 20V, V _{GS} = 10V I _D = 3A
Turn-On Rise Time (Note 10)	t _r	—	15.1	—		
Turn-Off Delay Time (Note 10)	t _{D(off)}	—	24.3	—		
Turn-Off Fall Time (Note 10)	t _f	—	5.3	—		

Notes: 8. Measured under pulsed conditions. Pulse width ≤ 300μs; duty cycle ≤ 2%
 9. For design aid only, not subject to production testing.
 10. Switching characteristics are independent of operating junction temperatures.

Typical Characteristics – Q1 N-Channel

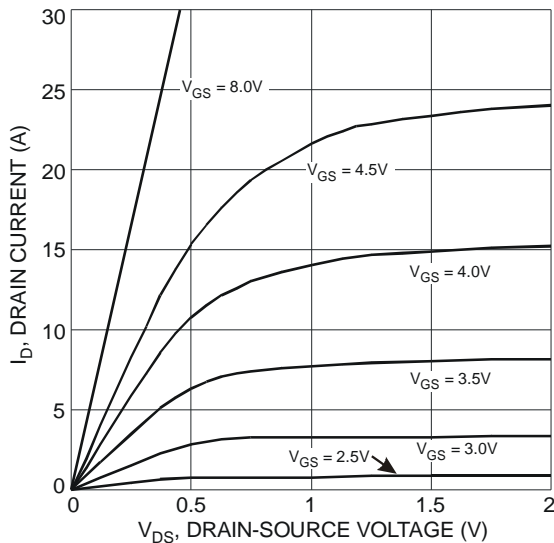

Fig. 1 Typical Output Characteristic

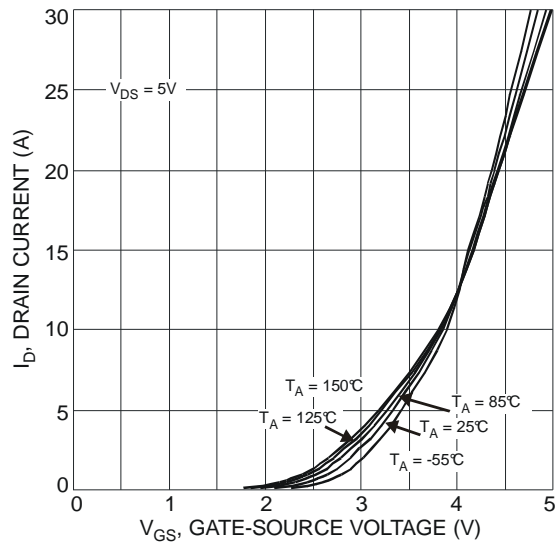

Fig. 2 Typical Transfer Characteristic

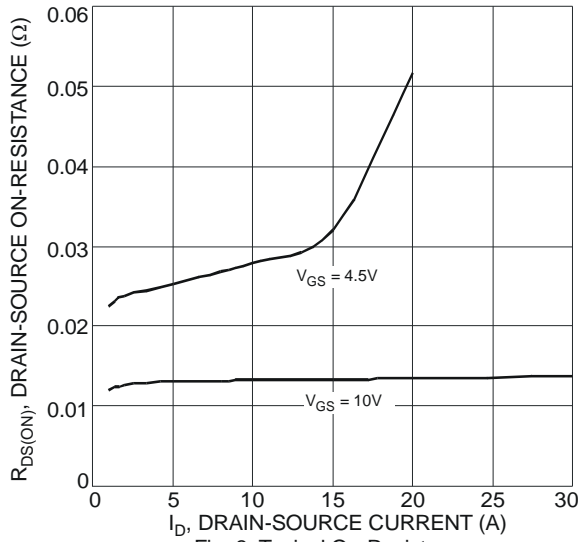

Fig. 3 Typical On-Resistance vs. Drain Current and Gate Voltage

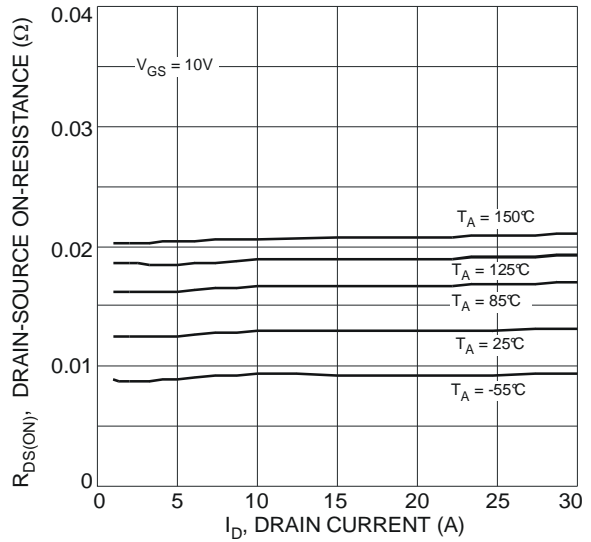

Fig. 4 Typical On-Resistance vs. Drain Current and Temperature

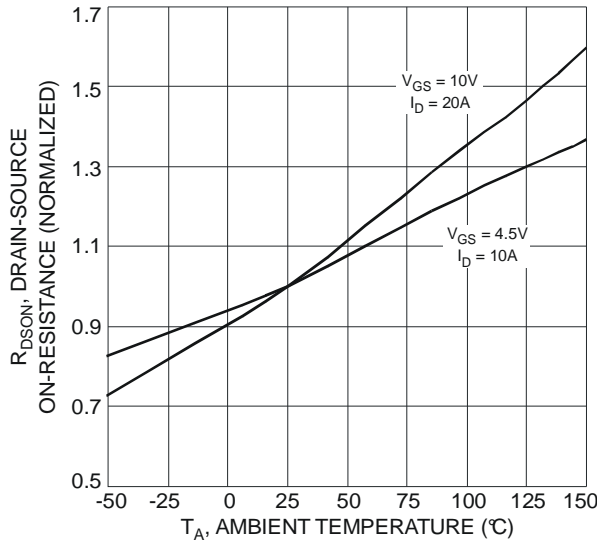

Fig. 5 On-Resistance Variation with Temperature

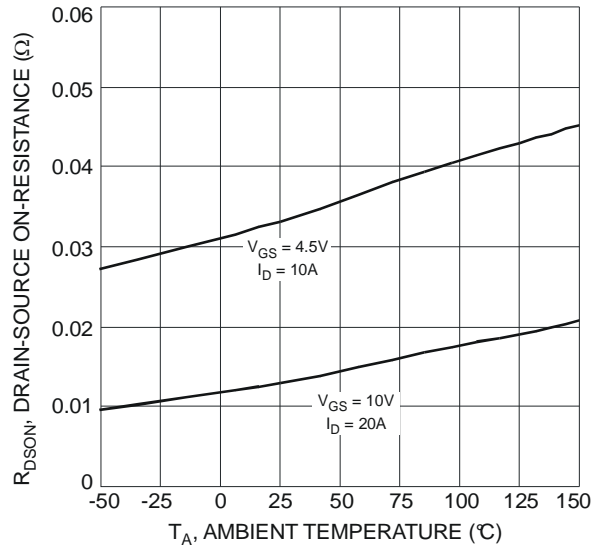

Fig. 6 On-Resistance Variation with Temperature

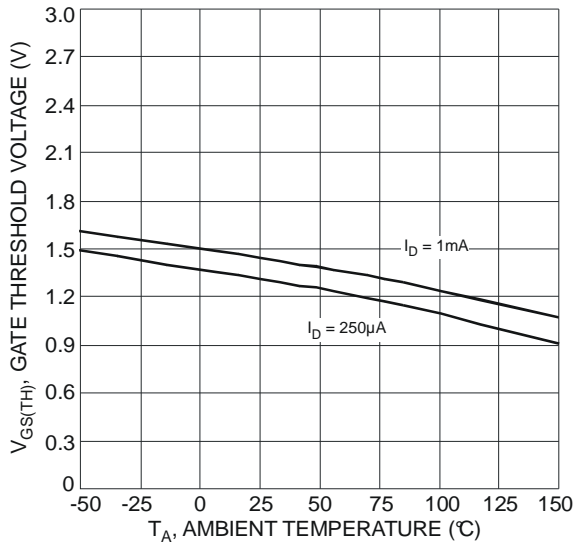

Fig. 7 Gate Threshold Variation vs. Ambient Temperature

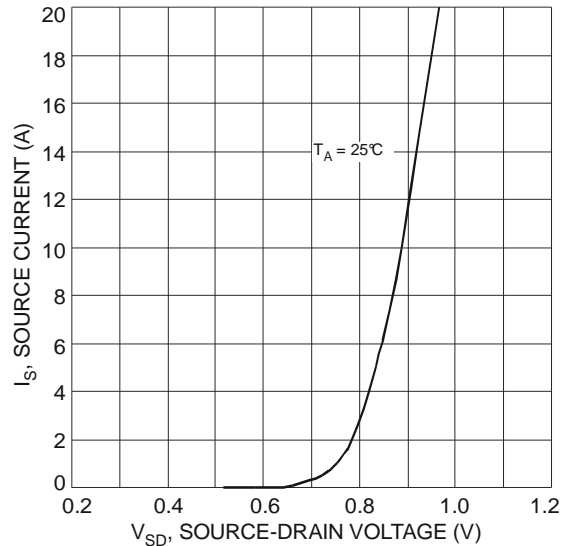

Fig. 8 Diode Forward Voltage vs. Current

DMC4040SSD

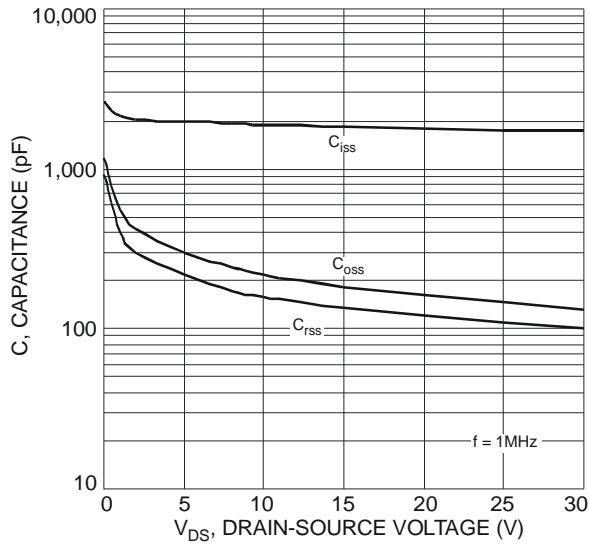

Fig. 9 Typical Total Capacitance

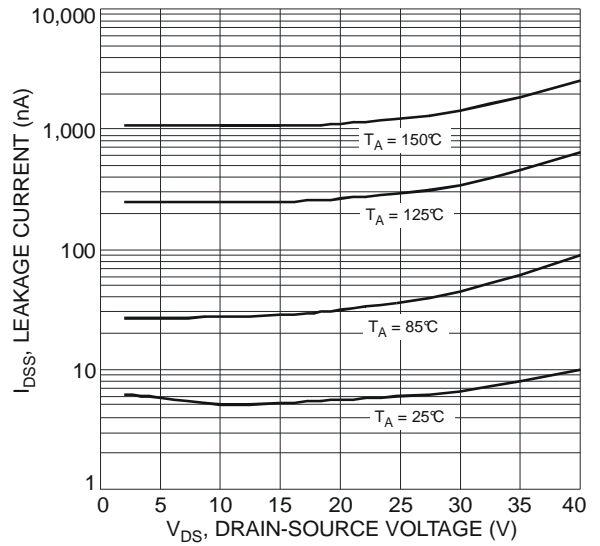

Fig. 10 Typical Leakage Current vs. Drain-Source Voltage

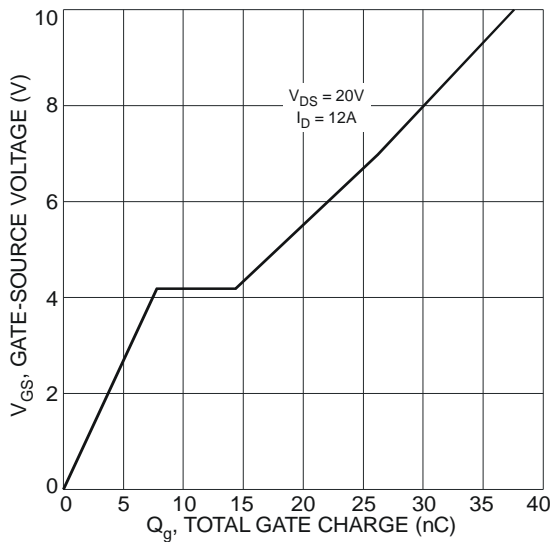

Fig. 11 Gate-Charge Characteristics

Electrical Characteristics – Q2 P-CHANNEL @T_A = 25°C unless otherwise specified

Characteristic	Symbol	Min	Typ	Max	Unit	Test Condition
OFF CHARACTERISTICS						
Drain-Source Breakdown Voltage	BV _{DSS}	-40	–	–	V	I _D = -250μA, V _{GS} = 0V
Zero Gate Voltage Drain Current	I _{DSS}	–	–	-1.0	μA	V _{DS} = -40V, V _{GS} = 0V
Gate-Source Leakage	I _{GSS}	–	–	±100	nA	V _{GS} = ±20V, V _{DS} = 0V
ON CHARACTERISTICS						
Gate Threshold Voltage	V _{GS(th)}	-0.8	-1.3	-1.8	V	I _D = -250μA, V _{DS} = V _{GS}
Static Drain-Source On-Resistance (Note 11)	R _{DS(on)}	–	0.018	0.025	Ω	V _{GS} = -10V, I _D = -3A
			0.030	0.045		V _{GS} = -4.5V, I _D = -3A
Forward Transconductance (Notes 11 & 12)	g _{fs}	–	16.6	–	S	V _{DS} = -5V, I _D = -3A
Diode Forward Voltage (Note 11)	V _{SD}	–	-0.7	-1.0	V	I _S = -1A, V _{GS} = 0V
DYNAMIC CHARACTERISTICS (Note 12)						
Input Capacitance	C _{iSS}	–	1643	–	pF	V _{DS} = -20V, V _{GS} = 0V f = 1MHz
Output Capacitance	C _{oss}	–	179	–		
Reverse Transfer Capacitance	C _{rss}	–	128	–		
Gate Resistance	R _g	–	6.43	–	Ω	V _{DS} = 0V, V _{GS} = 0V, f = 1MHz
Total Gate Charge (Note 13)	Q _g	–	14.0	–	nC	V _{GS} = -4.5V V _{DS} = -20V I _D = -3A
Total Gate Charge (Note 13)	Q _g	–	33.7	–		
Gate-Source Charge (Note 13)	Q _{gs}	–	5.5	–		
Gate-Drain Charge (Note 13)	Q _{gd}	–	7.3	–		
Turn-On Delay Time (Note 13)	t _{D(on)}	–	6.9	–	ns	V _{DD} = -20V, V _{GS} = -10V I _D = -3A
Turn-On Rise Time (Note 13)	t _r	–	14.7	–		
Turn-Off Delay Time (Note 13)	t _{D(off)}	–	53.7	–		
Turn-Off Fall Time (Note 13)	t _f	–	30.9	–		

Notes: 11. Measured under pulsed conditions. Pulse width ≤ 300μs; duty cycle ≤ 2%
 12. For design aid only, not subject to production testing.
 13. Switching characteristics are independent of operating junction temperatures.

Typical Characteristics – Q2 P-Channel

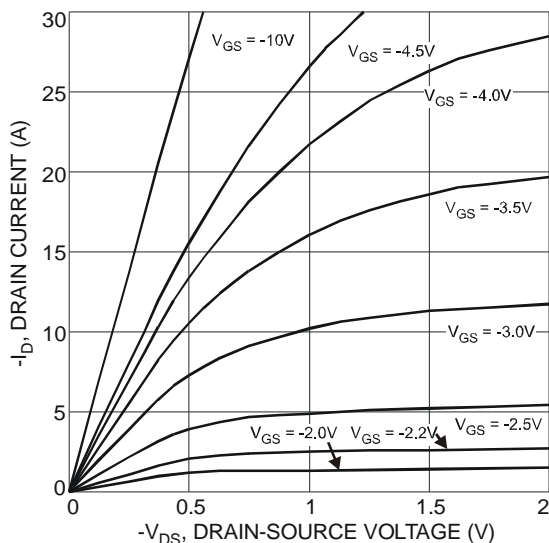

Fig. 12 Typical Output Characteristic

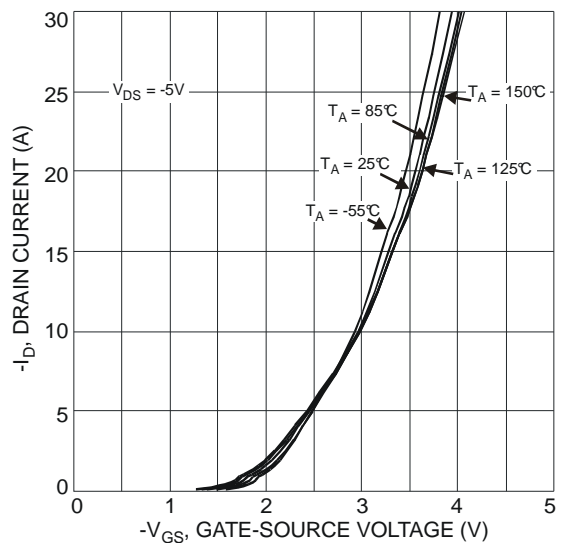

Fig. 13 Typical Transfer Characteristic

DMC4040SSD

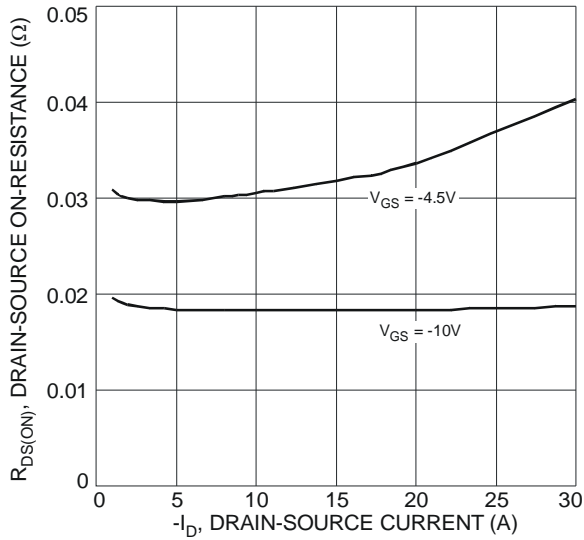

Fig. 14 Typical On-Resistance vs. Drain Current and Gate Voltage

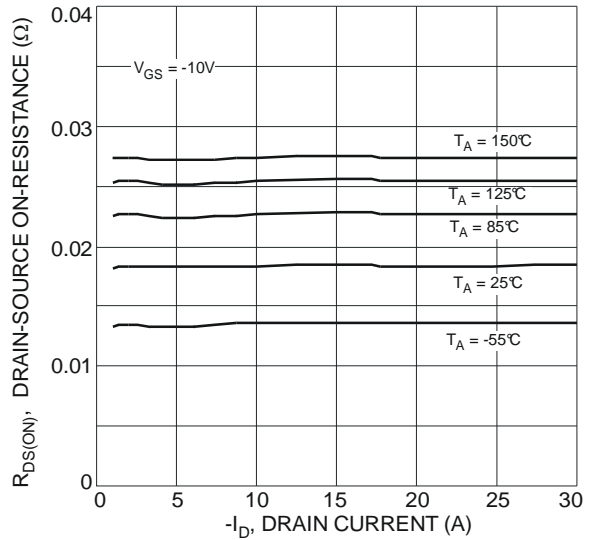

Fig. 15 Typical On-Resistance vs. Drain Current and Temperature

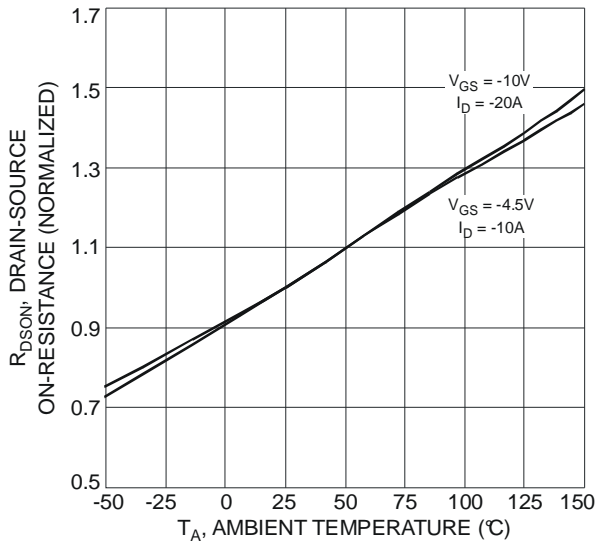

Fig. 16 On-Resistance Variation with Temperature

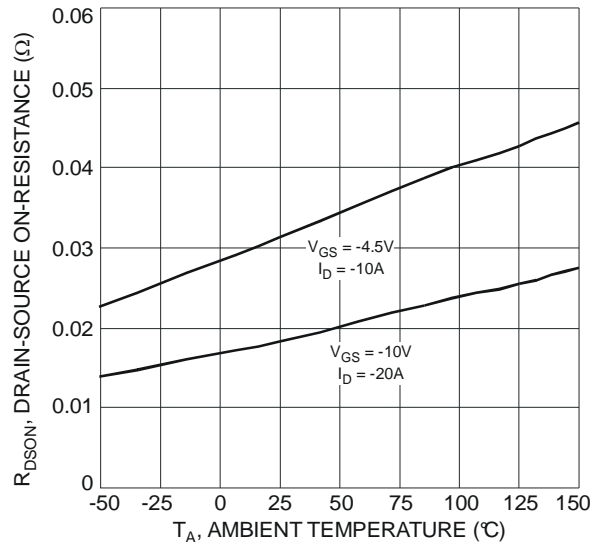

Fig. 17 On-Resistance Variation with Temperature

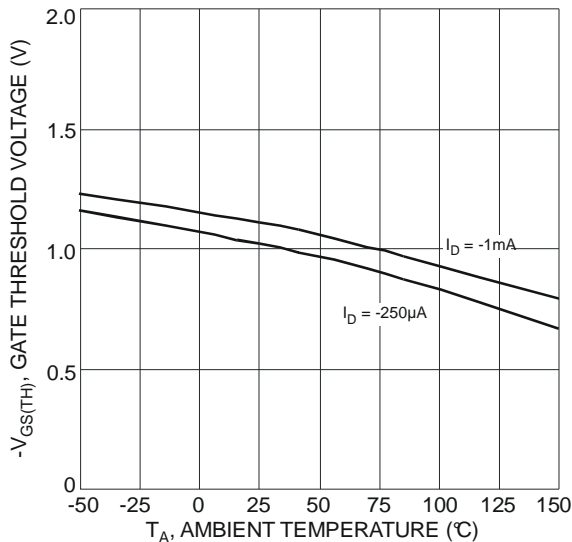

Fig. 18 Gate Threshold Variation vs. Ambient Temperature

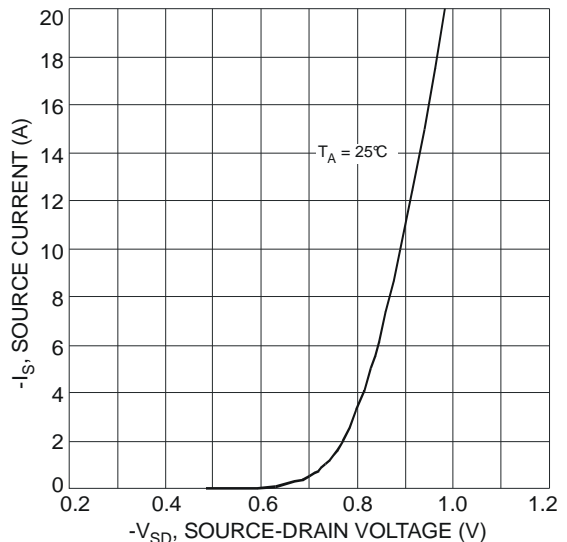

Fig. 19 Diode Forward Voltage vs. Current

DMC4040SSD

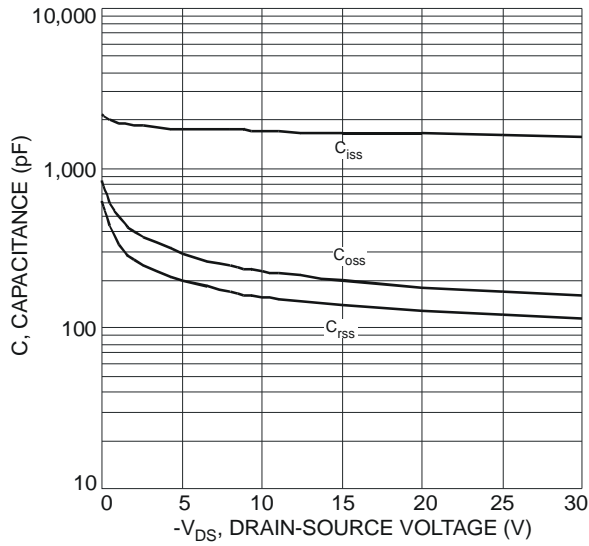

Fig. 20 Typical Total Capacitance

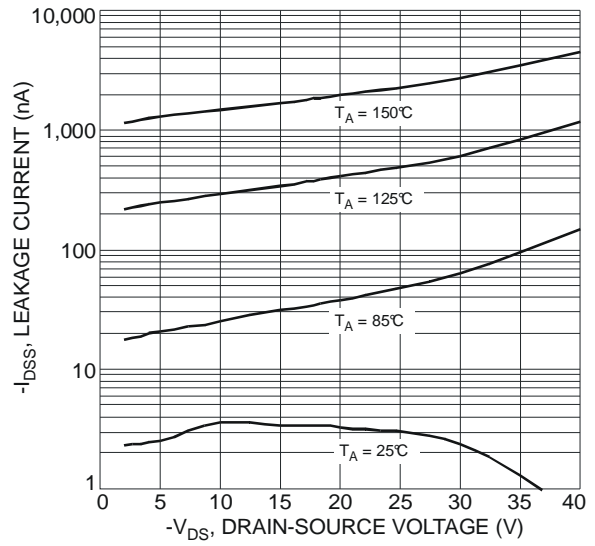

Fig. 21 Typical Leakage Current vs. Drain-Source Voltage

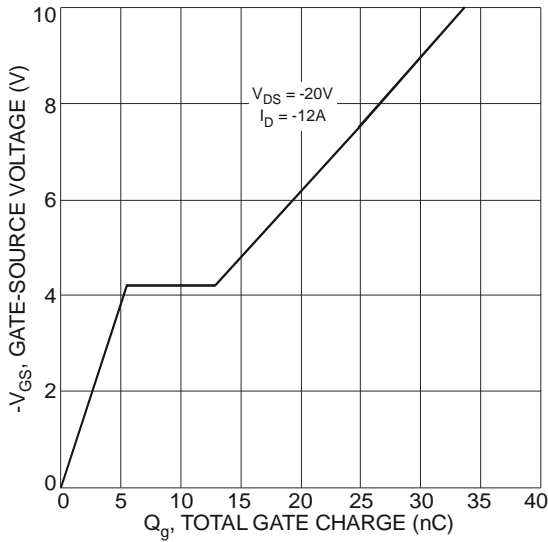
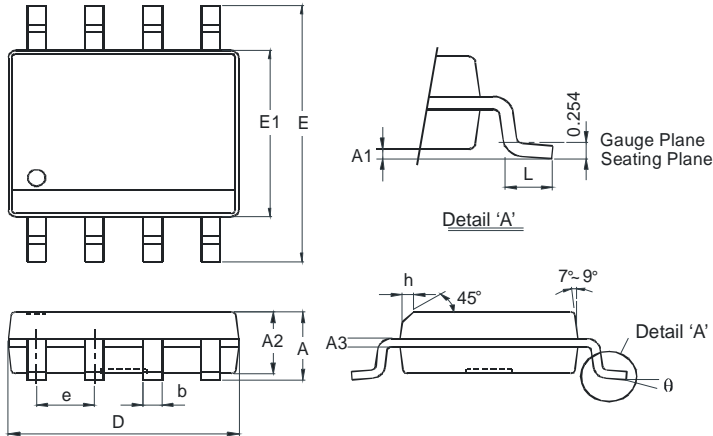

Fig. 22 Gate-Charge Characteristics

Package Outline Dimensions



SO-8		
Dim	Min	Max
A	-	1.75
A1	0.10	0.20
A2	1.30	1.50
A3	0.15	0.25
b	0.3	0.5
D	4.85	4.95
E	5.90	6.10
E1	3.85	3.95
e	1.27 Typ	
h	-	0.35
L	0.62	0.82
θ	0°	8°
All Dimensions in mm		

Suggested Pad Layout

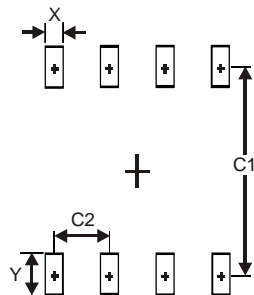

Dimensions	Value (in mm)
X	0.60
Y	1.55
C1	5.4
C2	1.27

IMPORTANT NOTICE

DIODES INCORPORATED MAKES NO WARRANTY OF ANY KIND, EXPRESS OR IMPLIED, WITH REGARDS TO THIS DOCUMENT, INCLUDING, BUT NOT LIMITED TO, THE IMPLIED WARRANTIES OF MERCHANTABILITY AND FITNESS FOR A PARTICULAR PURPOSE (AND THEIR EQUIVALENTS UNDER THE LAWS OF ANY JURISDICTION).

Diodes Incorporated and its subsidiaries reserve the right to make modifications, enhancements, improvements, corrections or other changes without further notice to this document and any product described herein. Diodes Incorporated does not assume any liability arising out of the application or use of this document or any product described herein; neither does Diodes Incorporated convey any license under its patent or trademark rights, nor the rights of others. Any Customer or user of this document or products described herein in such applications shall assume all risks of such use and will agree to hold Diodes Incorporated and all the companies whose products are represented on Diodes Incorporated website, harmless against all damages.

Diodes Incorporated does not warrant or accept any liability whatsoever in respect of any products purchased through unauthorized sales channel. Should Customers purchase or use Diodes Incorporated products for any unintended or unauthorized application, Customers shall indemnify and hold Diodes Incorporated and its representatives harmless against all claims, damages, expenses, and attorney fees arising out of, directly or indirectly, any claim of personal injury or death associated with such unintended or unauthorized application.

Products described herein may be covered by one or more United States, international or foreign patents pending. Product names and markings noted herein may also be covered by one or more United States, international or foreign trademarks.

LIFE SUPPORT

Diodes Incorporated products are specifically not authorized for use as critical components in life support devices or systems without the express written approval of the Chief Executive Officer of Diodes Incorporated. As used herein:

A. Life support devices or systems are devices or systems which:

1. are intended to implant into the body, or
2. support or sustain life and whose failure to perform when properly used in accordance with instructions for use provided in the labeling can be reasonably expected to result in significant injury to the user.

B. A critical component is any component in a life support device or system whose failure to perform can be reasonably expected to cause the failure of the life support device or to affect its safety or effectiveness.

Customers represent that they have all necessary expertise in the safety and regulatory ramifications of their life support devices or systems, and acknowledge and agree that they are solely responsible for all legal, regulatory and safety-related requirements concerning their products and any use of Diodes Incorporated products in such safety-critical, life support devices or systems, notwithstanding any devices- or systems-related information or support that may be provided by Diodes Incorporated. Further, Customers must fully indemnify Diodes Incorporated and its representatives against any damages arising out of the use of Diodes Incorporated products in such safety-critical, life support devices or systems.

Copyright © 2011, Diodes Incorporated

www.diodes.com