

DUAL COMPLEMENTARY PRE-BIASED TRANSISTORS

Features

- Epitaxial Planar Die Construction
- Surface Mount Package Suited for Automated Assembly
- Simplifies Circuit Design and Reduces Board Space
- **Lead Free, RoHS Compliant (Note 1)**
- **Halogen and Antimony Free "Green" Device (Note 2)**
- **Qualified to AEC-Q101 Standards for High Reliability**

Mechanical Data

- Case: SOT353
- Case Material: Molded Plastic, "Green" Molding Compound. UL Flammability Classification Rating 94V-0
- Moisture Sensitivity: Level 1 per J-STD-020
- Terminal Connections: See Diagram
- Terminals: Finish – Matte Tin Annealed Over Alloy 42 Leadframe. Solderable per MIL-STD-202, Method 208
- Weight: 0.006 grams (approximate)

SOT353

Top View

Bottom View

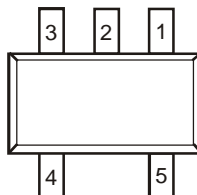

Package Pin Out Configuration

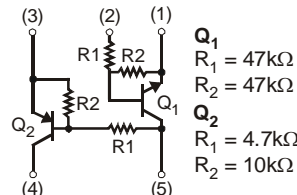

Device Schematic

Q_1
 $R_1 = 47k\Omega$
 $R_2 = 47k\Omega$
 Q_2
 $R_1 = 4.7k\Omega$
 $R_2 = 10k\Omega$

Ordering Information (Note 3)

| Part Number | Case | Packaging |
|-------------|--------|------------------|
| UMC5N-7 | SOT353 | 3000/Tape & Reel |

- Notes:
1. No purposefully added lead.
 2. Diodes Inc.'s "Green" policy can be found on our website at <http://www.diodes.com>.
 3. For packaging details, go to our website at <http://www.diodes.com>.

Marking Information

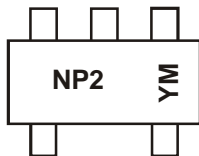

NP2 = Product Type Marking Code
 YM = Date Code Marking
 Y = Year (ex: U = 2007)
 M = Month (ex: 9 = September)

Date Code Key

| Year | 2007 | 2008 | 2009 | 2010 | 2011 | 2012 | 2013 | 2014 | 2015 |
|------|------|------|------|------|------|------|------|------|------|
| Code | U | V | W | X | Y | Z | A | B | C |

| Month | Jan | Feb | Mar | Apr | May | Jun | Jul | Aug | Sep | Oct | Nov | Dec |
|-------|-----|-----|-----|-----|-----|-----|-----|-----|-----|-----|-----|-----|
| Code | 1 | 2 | 3 | 4 | 5 | 6 | 7 | 8 | 9 | O | N | D |

Maximum Ratings, Pre-Biased NPN Transistor, Q₁ @T_A = 25°C unless otherwise specified

| Characteristic | Symbol | Value | Unit |
|-------------------|---------------------|------------|------|
| Supply Voltage | V _{CC} | 50 | V |
| Input Voltage | V _{IN} | -10 to +40 | V |
| Output Current | I _O | 30 | mA |
| Collector Current | I _{C(MAX)} | 100 | mA |

Maximum Ratings, Pre-Biased PNP Transistor, Q₂ @T_A = 25°C unless otherwise specified

| Characteristic | Symbol | Value | Unit |
|-------------------|---------------------|-----------|------|
| Supply Voltage | V _{CC} | -50 | V |
| Input Voltage | V _{IN} | -20 to +7 | V |
| Output Current | I _O | -100 | mA |
| Collector Current | I _{C(MAX)} | -100 | mA |

Thermal Characteristics

| Characteristic | Symbol | Value | Unit |
|------------------------------------------------------|-----------------------------------|-------------|------|
| Power Dissipation (Note 4) | P _D | 150 | mW |
| Thermal Resistance, Junction to Ambient Air (Note 4) | R _{θJA} | 833 | °C/W |
| Operating and Storage Temperature Range | T _J , T _{STG} | -55 to +150 | °C |

Notes: 4. Device mounted on FR-4 PCB; pad layout as shown on Diodes Inc. suggested pad layout document AP02001, which can be found on our website at <http://www.diodes.com>.

Electrical Characteristics, Pre-Biased NPN Transistor, Q₁ @T_A = 25°C unless otherwise specified

| Characteristic | Symbol | Min | Typ | Max | Unit | Test Condition |
|---------------------------------|--------------------------------|------|-----|------|------|----------------------------------------------------------|
| Input Voltage | (Note 5) V _{I(OFF)} | 0.5 | — | — | V | V _{CC} = 5V, I _O = 100μA |
| | (Note 6) V _{I(ON)} | — | — | 3 | V | V _O = 0.3V, I _O = 2mA |
| Output Voltage | V _{O(ON)} | — | 0.1 | 0.3 | V | I _O /I _I = 10mA/0.5 mA |
| Input Current | I _I | — | — | 0.18 | mA | V _I = 5V |
| Output Current | I _{O(OFF)} | — | — | 0.5 | μA | V _{CC} = 50V, V _I = 0V |
| DC Current Gain | G _I | 68 | — | — | — | V _O = 5V, I _O = 5mA |
| Gain-Bandwidth Product (Note 7) | f _T | — | 250 | — | MHz | V _{CE} = 10V, I _E = -5mA, f = 100MHz |
| Input Resistance | R ₁ | 32.9 | 47 | 61.1 | kΩ | — |
| Resistance Ratio | R ₂ /R ₁ | 0.8 | 1 | 1.2 | — | — |

Notes: 5. The device is guaranteed to be in "OFF" state with V_{I(OFF)} up to 0.5V
 6. The device is guaranteed to be in "ON" state with V_{I(ON)} starting from 3V
 7. Characteristic of Transistor – for reference only.

Electrical Characteristics, Pre-Biased PNP Transistor, Q₂ @T_A = 25°C unless otherwise specified

| Characteristic | Symbol | Min | Typ | Max | Unit | Test Condition |
|---------------------------------|--------------------------------|------|------|------|------|----------------------------------------------------------|
| Input Voltage | V _{I(OFF)} | -0.3 | — | — | V | V _{CC} = -5V, I _O = -100μA |
| | V _{I(ON)} | — | — | -2.5 | V | V _O = -0.3V, I _O = -20mA |
| Output Voltage | V _{O(ON)} | — | -0.1 | -0.3 | V | I _O /I _I = -10mA/-0.5 mA |
| Input Current | I _I | — | — | -1.8 | mA | V _I = -5V |
| Output Current | I _{O(OFF)} | — | — | -0.5 | μA | V _{CC} = -50V, V _I = 0V |
| DC Current Gain | G _I | 30 | — | — | — | V _O = -5V, I _O = -10mA |
| Gain-Bandwidth Product (Note 7) | f _T | — | 250 | — | MHz | V _{CE} = -10V, I _E = 5mA, f = 100MHz |
| Input Resistance | R ₁ | 3.29 | 4.7 | 6.11 | kΩ | — |
| Resistance Ratio | R ₂ /R ₁ | 1.7 | 2.1 | 2.6 | — | — |

Notes: 8. The device is guaranteed to be in "OFF" state with V_{I(OFF)} up to -0.3V
 9. The device is guaranteed to be in "ON" state with V_{I(ON)} starting from -2.5V
 10. Characteristic of Transistor – for reference only.

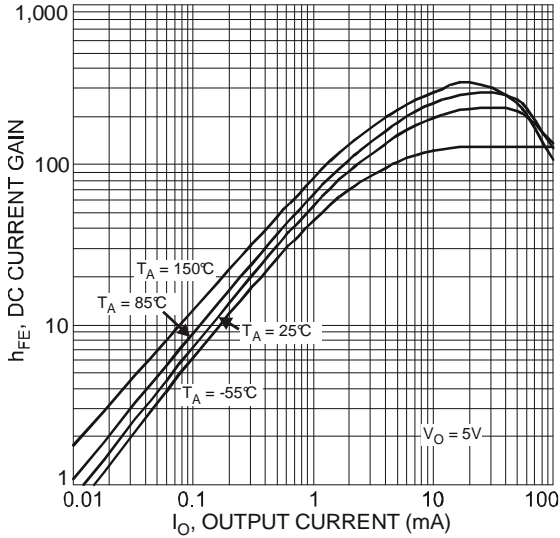

Fig. 1 Typical DC Current Gain vs. Output Current (Q1, NPN)

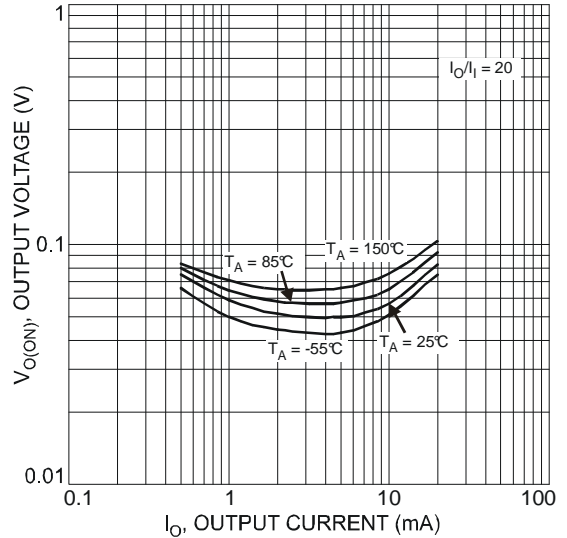

Fig. 2 Typical Output Voltage vs. Output Current (Q1, NPN)

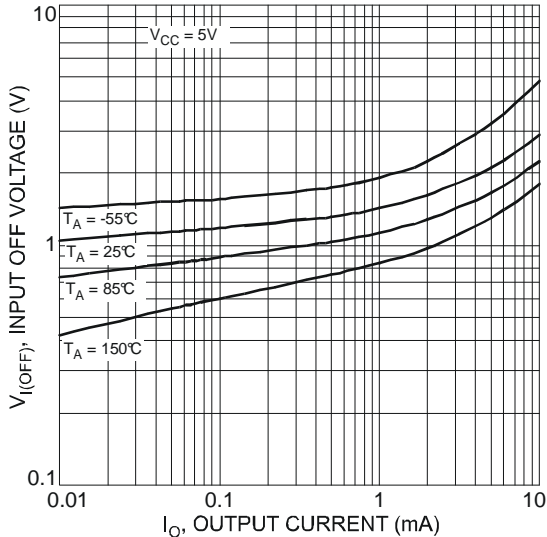

Fig. 3 Typical Input OFF Voltage vs. Output Current (Q1, NPN)

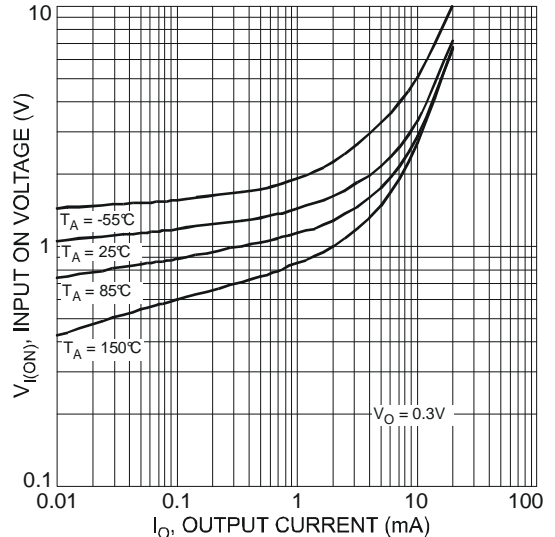

Fig. 4 Typical Input ON Voltage vs. Output Current (Q1, NPN)

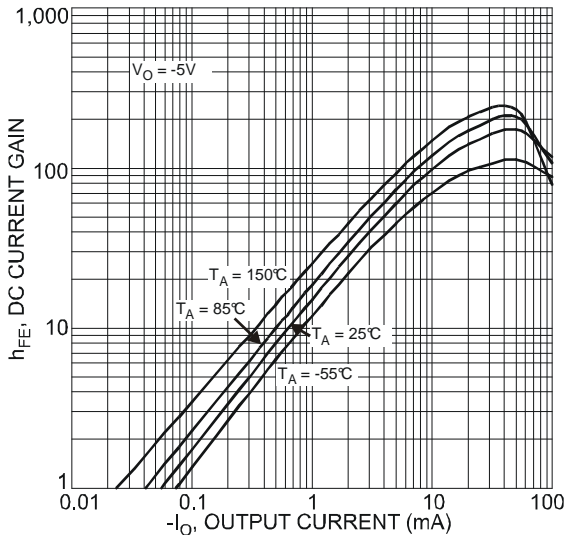

Fig. 5 Typical DC Current Gain vs. Output Current (Q2, PNP)

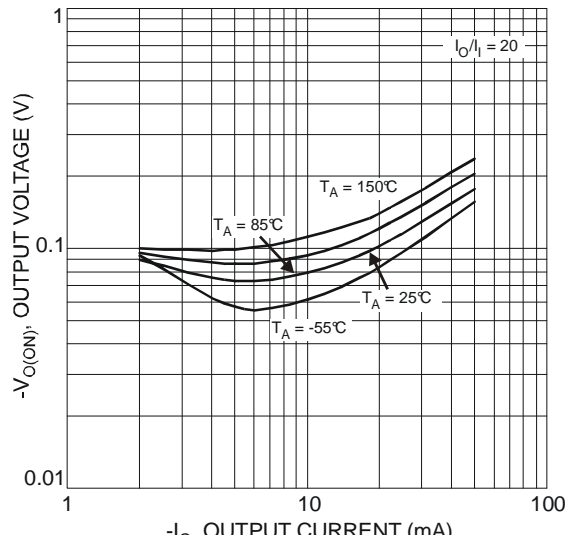

Fig. 6 Typical Output Voltage vs. Output Current (Q2, PNP)

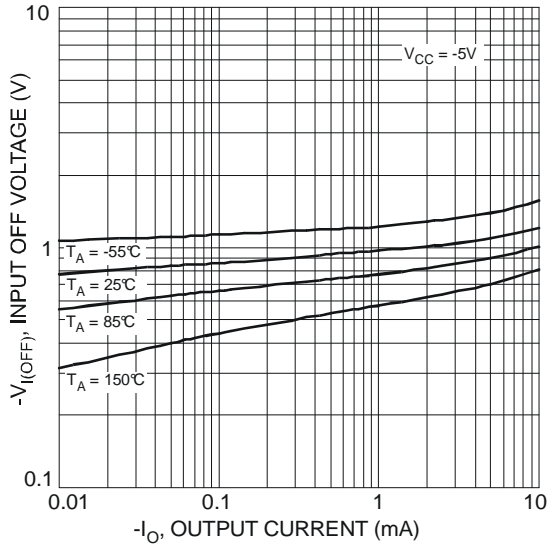

Fig. 7 Typical Input Off Voltage vs. Output Current (Q2, PNP)

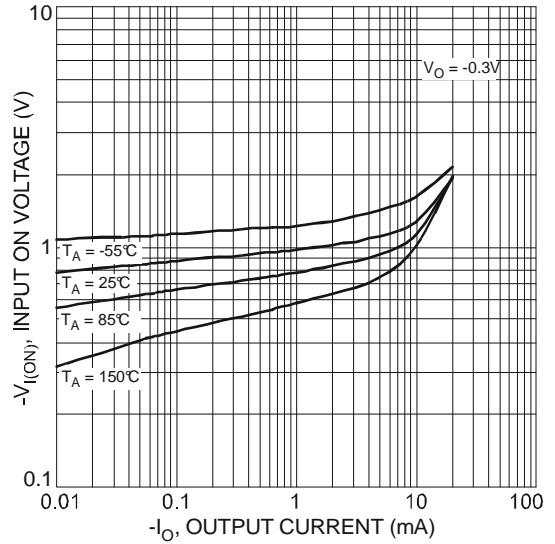
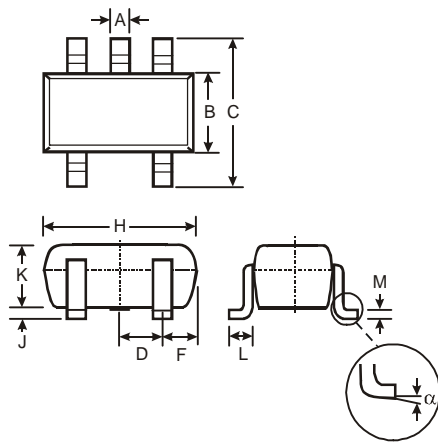

Fig. 8 Typical Input ON Voltage vs. Output Current (Q2, PNP)

Package Outline Dimensions



| SOT353 | | |
|----------------------|----------|------|
| Dim | Min | Max |
| A | 0.10 | 0.30 |
| B | 1.15 | 1.35 |
| C | 2.00 | 2.20 |
| D | 0.65 Typ | |
| F | 0.40 | 0.45 |
| H | 1.80 | 2.20 |
| J | 0 | 0.10 |
| K | 0.90 | 1.00 |
| L | 0.25 | 0.40 |
| M | 0.10 | 0.22 |
| α | 0° | 8° |
| All Dimensions in mm | | |

Suggested Pad Layout

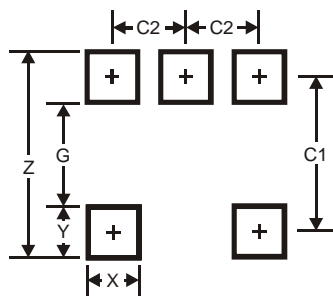

| Dimensions | Value (in mm) |
|------------|---------------|
| Z | 2.5 |
| G | 1.3 |
| X | 0.42 |
| Y | 0.6 |
| C1 | 1.9 |
| C2 | 0.65 |

IMPORTANT NOTICE

DIODES INCORPORATED MAKES NO WARRANTY OF ANY KIND, EXPRESS OR IMPLIED, WITH REGARDS TO THIS DOCUMENT, INCLUDING, BUT NOT LIMITED TO, THE IMPLIED WARRANTIES OF MERCHANTABILITY AND FITNESS FOR A PARTICULAR PURPOSE (AND THEIR EQUIVALENTS UNDER THE LAWS OF ANY JURISDICTION).

Diodes Incorporated and its subsidiaries reserve the right to make modifications, enhancements, improvements, corrections or other changes without further notice to this document and any product described herein. Diodes Incorporated does not assume any liability arising out of the application or use of this document or any product described herein; neither does Diodes Incorporated convey any license under its patent or trademark rights, nor the rights of others. Any Customer or user of this document or products described herein in such applications shall assume all risks of such use and will agree to hold Diodes Incorporated and all the companies whose products are represented on Diodes Incorporated website, harmless against all damages.

Diodes Incorporated does not warrant or accept any liability whatsoever in respect of any products purchased through unauthorized sales channel. Should Customers purchase or use Diodes Incorporated products for any unintended or unauthorized application, Customers shall indemnify and hold Diodes Incorporated and its representatives harmless against all claims, damages, expenses, and attorney fees arising out of, directly or indirectly, any claim of personal injury or death associated with such unintended or unauthorized application.

Products described herein may be covered by one or more United States, international or foreign patents pending. Product names and markings noted herein may also be covered by one or more United States, international or foreign trademarks.

LIFE SUPPORT

Diodes Incorporated products are specifically not authorized for use as critical components in life support devices or systems without the express written approval of the Chief Executive Officer of Diodes Incorporated. As used herein:

A. Life support devices or systems are devices or systems which:

1. are intended to implant into the body, or
2. support or sustain life and whose failure to perform when properly used in accordance with instructions for use provided in the labeling can be reasonably expected to result in significant injury to the user.

B. A critical component is any component in a life support device or system whose failure to perform can be reasonably expected to cause the failure of the life support device or to affect its safety or effectiveness.

Customers represent that they have all necessary expertise in the safety and regulatory ramifications of their life support devices or systems, and acknowledge and agree that they are solely responsible for all legal, regulatory and safety-related requirements concerning their products and any use of Diodes Incorporated products in such safety-critical, life support devices or systems, notwithstanding any devices- or systems-related information or support that may be provided by Diodes Incorporated. Further, Customers must fully indemnify Diodes Incorporated and its representatives against any damages arising out of the use of Diodes Incorporated products in such safety-critical, life support devices or systems.

Copyright © 2011, Diodes Incorporated

www.diodes.com