



CML Microcircuits  
COMMUNICATION SEMICONDUCTORS

# DE8661

## V.22bis User Manual for a "socket modem"

UM8661/4 June 2004

Provisional Issue

### 1.0 Features

- CMX866-based socket modem Reference Design
- Fully Isolated 2-Wire Line Interface
- Opto Isolated Ring Detect Circuitry and OptoMOS Hook Relay
- Integral AT Command Set with 'Fast Connect'
- PC Controlled via Terminal Emulator
- FCC68 or CTR21 DAA
- Single 3V or 5V dc power supply operation
- Break-off PCB sections support 'desktop' and 'socket' modem use
- PCB layout data provided

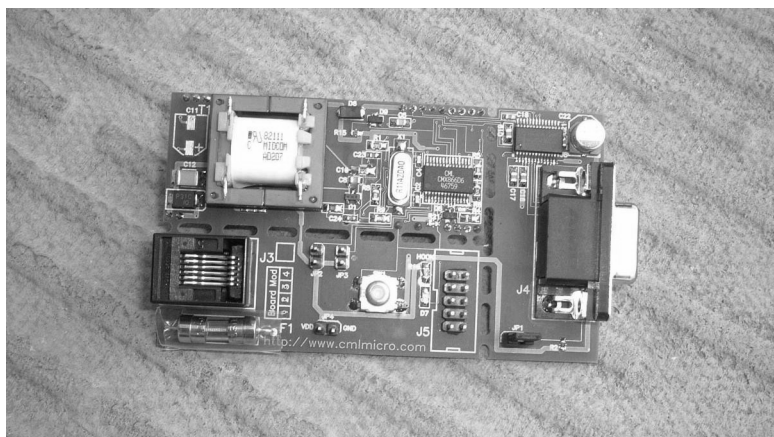

### 1.1 Brief Description

The DE8661 Demonstration Board is a reference design for the CMX866 V.22 bis AT command modem IC. The main "socket modem" section contains the CMX866 and associated components in addition to the line interface components. Attached to the main section are two break-off sections which contain a 9-pin D type socket for PC serial communications, RJ11 line connector, supply voltage connector and a hook-state LED. The CMX866 contains an on-chip  $\mu$ Controller, which interprets AT Commands issued via a standard terminal emulator program running on a host PC or via an external  $\mu$ Controller.

Interfacing to the Demonstration Board can be via socket pins on the socket modem section, or via the connectors provided on the break-off sections. The board can be operated at 3V or 5V dc, which must be provided by an external, regulated power supply.

The PCB has been laid out for both CTR21 and FCC68 compliant DAA designs. However the components fitted are for the simplified European/FCC68 design. Users wishing to convert to CTR21 should contact CML.

**CONTENTS**

<u>Section</u>		<u>Page</u>
<b>1.0</b>	<b>Features .....</b>	<b>1</b>
<b>1.1</b>	<b>Brief Description .....</b>	<b>1</b>
<b>1.2</b>	<b>Preliminary Information .....</b>	<b>4</b>
	<b>1.2.1 Equipment.....</b>	<b>4</b>
	<b>1.2.2 Handling Precautions.....</b>	<b>4</b>
	<b>1.2.3 Approvals.....</b>	<b>4</b>
<b>1.3</b>	<b>Quick Start.....</b>	<b>5</b>
	<b>1.3.1 Setting-Up .....</b>	<b>5</b>
	<b>1.3.2 Operation .....</b>	<b>5</b>
<b>1.4</b>	<b>Signal Lists.....</b>	<b>7</b>
<b>1.5</b>	<b>Circuit Schematics and Board Layout .....</b>	<b>9</b>
<b>1.6</b>	<b>Detailed Description.....</b>	<b>11</b>
	<b>1.6.1 Hardware Description.....</b>	<b>11</b>
	<b>1.6.2 Serial Interface .....</b>	<b>12</b>
	<b>1.6.3 Reset Function.....</b>	<b>13</b>
	<b>1.6.4 AT Command and S-Register Summary.....</b>	<b>15</b>
	<b>1.6.5 General Description of AT Commands.....</b>	<b>17</b>
	<b>1.6.6 Modem Result Codes .....</b>	<b>18</b>
	<b>1.6.7 Terminal Emulator .....</b>	<b>18</b>
<b>1.7</b>	<b>Performance Specification .....</b>	<b>20</b>
	<b>1.7.1 Electrical Performance .....</b>	<b>20</b>

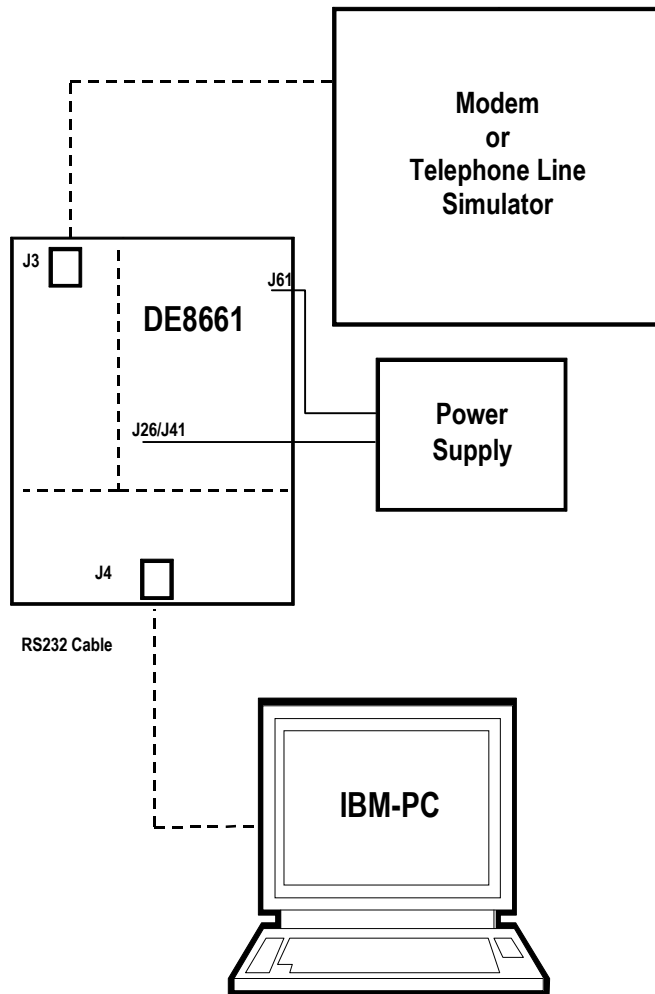

Figure 1 System Diagram

## **1.2 Preliminary Information**

### **1.2.1 Equipment**

The following equipment is needed to use this demonstration board:

#### **1.2.1.1 3Vdc or 5Vdc Regulated Power Supply**

#### **1.2.1.2 A PC equipped with a serial port running a terminal emulation program such as Microsoft's HyperTerminal.**

### **1.2.2 Handling Precautions**

#### **1.2.2.1 Static Protection**

This product uses low power CMOS circuits, which can be damaged by electrostatic discharge. Partially damaged circuits can function erroneously, leading to misleading results. Observe ESD precautions at all times when handling this product.

#### **1.2.2.2 Contents - Unpacking**

Please ensure that you have received all of the items on the separate information sheet (EK8661) and notify CML within 7 working days if the delivery is incomplete.

### **1.2.3 Approvals**

**This product is designed to meet CTR21 or FCC68 telecom approval requirements. Users are advised to observe local statutory requirements which may apply to this product, before direct or indirect connection to any public telecommunication system.**

## 1.3 Quick Start

This section provides instructions for users who wish to experiment immediately with the demonstration board. A fuller description of the board and its use appears later in this document.

### 1.3.1 Setting-Up

**THE DE8661 COMES PRE-CONFIGURED AS AN FCC68 MODEM, USING THE CMX866 D6 28-pin SSOP DEVICE, FOR OPERATION AT 5.0 VOLTS. See section 1.6 for the alternative component values required for 3.0V or CTR21 operation.**

An RJ11 (US style) phone jack socket, J3, for 2-wire line connection is provided on one of the break-off board sections. Power can be connected via socket pins **61(VDD)** and **41(GND)** (see figure 2.0, section 1.5), or via jumper JP4 on the break-off section.

Attach the 9-way RS232 cable between connector J4 and the serial port of the PC. Connect an external modem/line simulator to the evaluation kit using a suitable RJ11 telephone cable (not supplied).

The DE8661 is supplied with the break-off sections of the board intact. If a socket modem using the industry standard footprint is required, detach these break-off sections from the Demonstration Board PCB by using a suitable tool to scribe along the perforations that join the break-off sections to the main PCB. Scribe on both top and bottom sides of the board and ensure that the scribed line completely cuts any copper tracks entering or leaving the break-off sections from the main PCB. When this is done, gently break-off the first section on which connector J4 (9-pin D Type socket) is mounted, then break-off the second section on which the RJ11 socket is mounted. All connections to the remaining socket modem must now be made through the PCB connector pins.

### 1.3.2 Operation

The DE8661 demonstration board allows the user to perform calling, answering and simple data transfer with an external third party modem (not supplied). In order to provide central office/exchange dc line voltage, a suitable central office simulator is also required.

The board is controlled by the AT command set described in Section 1.6.4. These commands can be sent to the DE8661 from a terminal emulator program running on a host PC or from an external  $\mu$ Controller. A suitable emulator is the 'HyperTerminal' program, which operates under Windows 95 upwards. The DE8661 AT command set consists of Basic, Extended and CML Specific commands.

The board has two modes of operation:

#### **AT Command Mode**

In this mode the CMX866 on-chip AT command processor checks to see if the user has typed a valid AT command. When a valid command is received, it is interpreted then actioned by the CMX866. When operating in this mode, the user can instruct the DE8661 to manually answer a call, originate a call, go on/off hook, read/write to S-registers, issue CML specific AT commands, and perform any number of other AT command functions. The board always starts in AT Command mode after power is applied and board initialisation is complete.

The Dial and Answer commands will execute the relevant DTMF transmit, call progress tone detection and negotiation (handshaking) functions before a connection to a remote modem/simulator can be established. Negotiation may be aborted by pushing any key.

Note: If the S0 register is modified to a non-zero value during this operating mode the CMX866 will poll its status register every 20ms to check for ring detection. If valid ringing is detected the DE8661 will automatically answer a call after n ring cycles, where n is equivalent to the contents of the S0 register.

### **Data Transfer Mode**

After gaining a connection (i.e. successful negotiation) with a remote modem the board will operate in data transfer mode. In this mode the board will transmit all the data it receives from the RS232 computer terminal or external  $\mu$ Controller to the remote modem via the 2-wire line. Likewise any data received from the remote modem via the 2-wire line will be sent to the RS232 computer terminal or external  $\mu$ Controller.

Whilst operating in this mode the data stream from the RS232 computer terminal or external  $\mu$ Controller is monitored for the escape code sequence (+++). If this sequence is encountered during data transfer the board will revert to on-line AT command mode. Whilst in on-line AT command mode, the remote modem connection may be aborted by typing ATH0 (instructs the DE8661 to go on-hook). Alternatively the user can enter relevant AT commands or return to data transfer mode by using the ATO command.

The modem line speed is much lower than the speed of the RS232 interface (RS232 is running at 9600bps). To prevent the CMX866 internal data buffer from overflowing, the data flow between the host system and the RS232 interface on the DE8661 is controlled using the CTS (Clear to Send) hardware handshake line.

The CMX866 settings used during negotiation and data transfer will be based on the contents of the S-registers when the call was originated or answered. The S-registers are described in Section 1.6.4. Certain S-register settings (relevant to the CMX866 configuration), modified during on-line AT command mode, will only take effect when a new call is originated or answered. For example, new CMX866 Tx gain settings (S25 register) modified in on-line AT command mode will be ignored until the next call.

## 1.4 Signal Lists

CONNECTOR PINOUT				
Connector Ref.	Connector Pin No.	Signal Name	Signal Type	Description
J1		TIP	Bi	Socket pin - Tip
J2		RING	Bi	Socket pin – Ring
J3	3	RING	Bi	RJ11 connector – Ring
	4	TIP	Bi	RJ11 connector – Tip
J4	1	DCD	Output	9-pin D Type connector – Host DCD
	2	RXD	Output	9-pin D Type connector – Host RXD
	3	TXD	Input	9-pin D Type connector – Host TXD
	4	DTR	Input	9-pin D Type connector – Host DTR
	5	VSS	Power	9-pin D Type connector – Host GND
	6	DSR	Output	9-pin D Type connector - Host DSR
	7	RTS	Input	9-pin D Type connector – Host RTS
	8	CTS	Output	9-pin D Type connector - Host CTS
	9	RI	Output	9-pin D Type connector – Host RI
J24		/RESET	Input	Socket pin – CMX866 reset
J26		VSS	Power	VSS connection
J29		N/C		
J30		N/C		
J31		N/C		
J32		N/C		
J33		/RTSTTL	Input	Socket pin – CMX866 RTSN
J34		/RXDTTL	Output	Socket pin – CMX866 RXD
J35		/TXDTTL	Input	Socket pin – CMX866 TXD
J36		/RITTL	Output	Socket pin – CMX866 RIN
J37		/DSRTTL	Output	Socket pin – CMX866 DSRN
J38		/CTSTTL	Output	Socket pin – CMX866 CTSN
J39		/DCDTTL	Output	Socket pin – CMX866 DCDN
J40		/DTRTTL	Input	Socket pin – CMX866 DTRN
J41		Vss	Power	Vss connection
J61		VDD	Power	+ve power from external power supply
J62		N/C		
J63		N/C		

LEDs	
LED Ref.	Description
D7	Illuminated when the line is in an off-hook state

JUMPERS			
Jumper Ref.	Positions	Default Position	Description
JP1	1 - 2	S/C	RS232 Receiver enable (U8)
JP4	1 - 2	O/C	Allows a supply voltage to be physically connected to the top side of the PCB.

**Notes:** Bi = Bidirectional  
S/C = Short Circuit  
O/C = Open Circuit  
N/C = Not Connected

### 1.5 Circuit Schematics and Board Layout

For clarity circuit schematics are available as separate, high resolution, files.

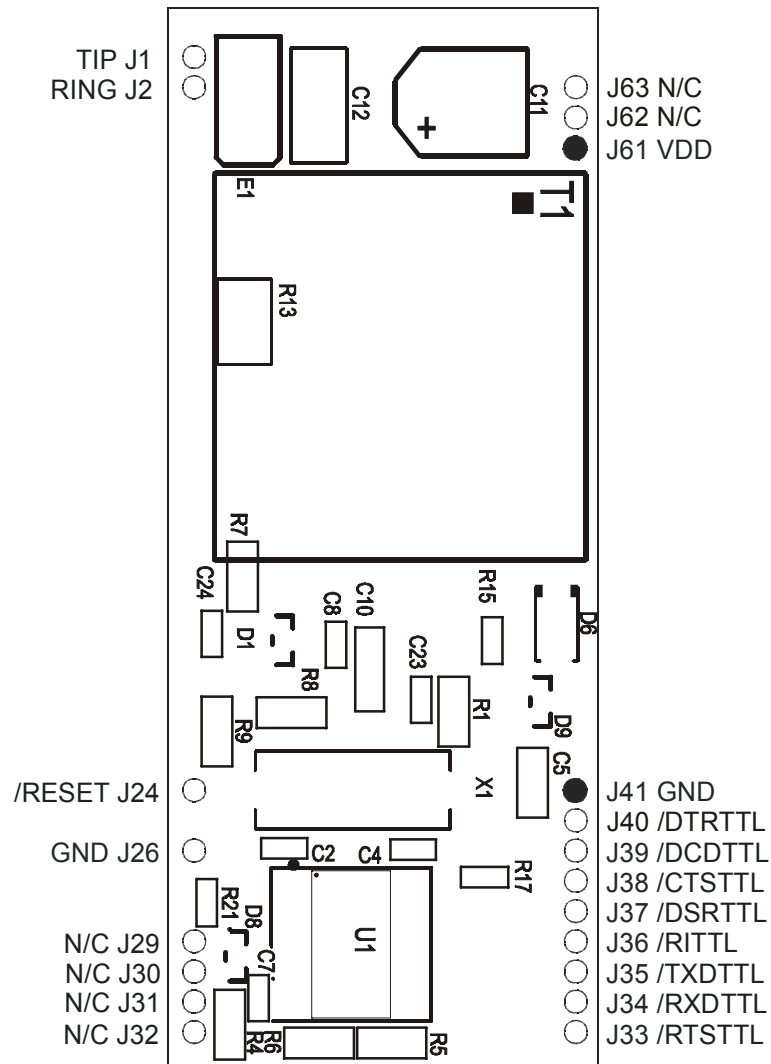

Figure 2 Socket Section Pinout (topview)

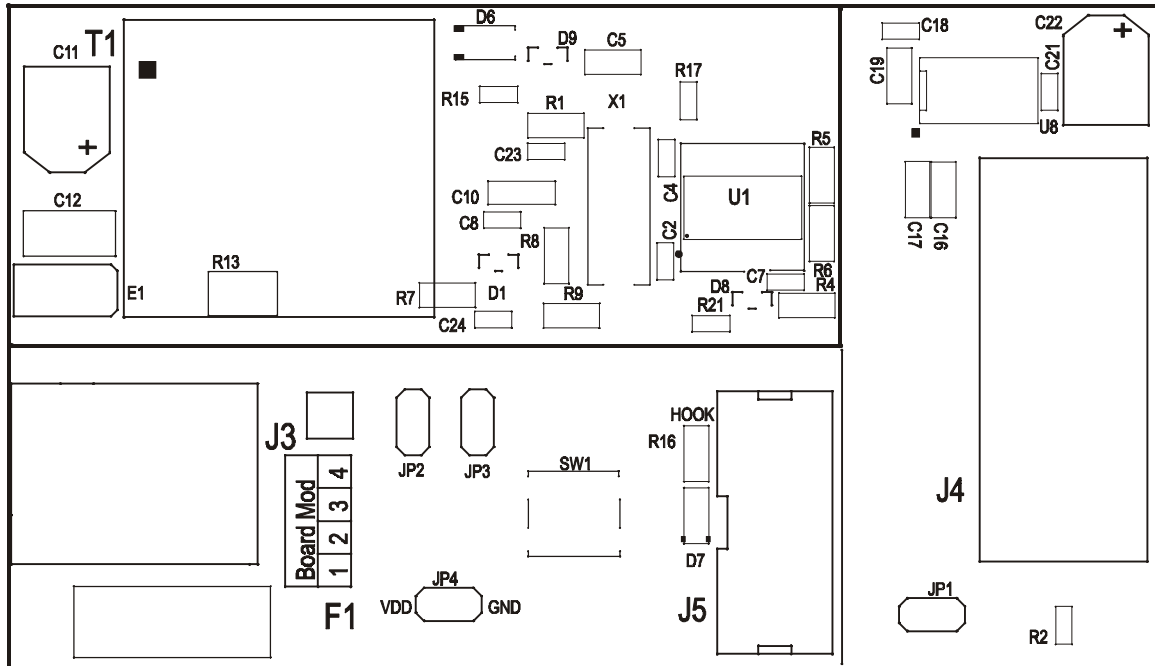

Figure 3a DE8661 Top Silk Screen

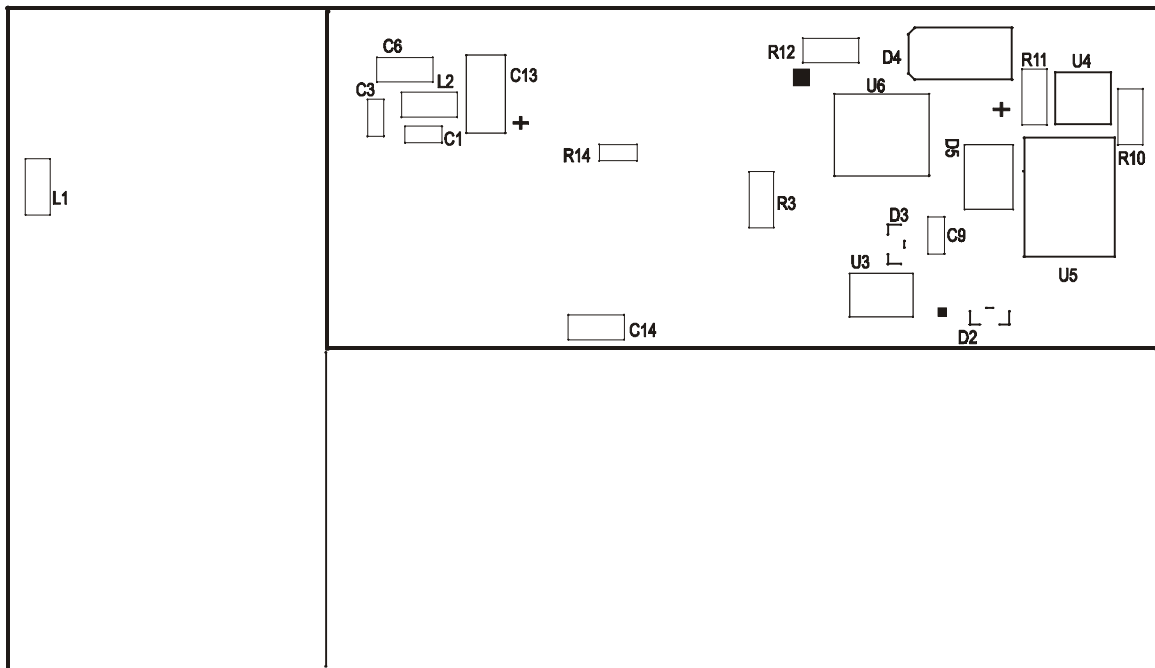

Figure 3b DE8661 Bottom Silk Screen

## 1.6 Detailed Description

### 1.6.1 Hardware Description

#### 1.6.1.1 Operating Voltage

The DE8661 can be operated at a VDD of 3 or 5Vdc (default), supplied by an external regulated power supply. Tables of component values for CTR21 and FCC68 DAAs are shown below:

CTR21 DAA					
VDD	R6	R7	C24	R12	D1
3.0 V	91K (93.5k)	160k	180pF	220R	3.0V
5.0 V	56K (57.6k)	180k	220pF	620R	4.3V

FCC68 DAA					
VDD	R6	R7	C24	R12	D1
3.0 V	100K (107k)	160k	39pF	220R	3.0V
5.0 V	62K (64.9k)	180k	47pF	620R	4.3V

(The values shown in brackets are optimal values)

#### 1.6.1.2 Clock/Oscillator

The CMX866 is clocked at a frequency of 11.0592MHz, which is provided by crystal X1.

#### 1.6.1.3 On-hook Caller ID

This function provides a high impedance, on-hook AC path for the routing of Caller ID signals to the CMX868. Components C9, R5 provide this transmission path. C9 bypasses the optoMOS relay hook switch, allowing AC signals to pass through T1 when the socket modem is in an on-hook state. The CMX866 has a switched inverting input (pin 11) which is used to compensate for input signal losses incurred while in the on-hook state.

#### 1.6.1.4 Simplified FCC68 Compliant DAA, as Shipped

The values of R4, R6, R7, R8, R9, C8 and C24 are optimal values with respect to the Midcom 82111 wet line transformer. Parts C10 and D4 are not required for this simplified design but are replaced with 0Ω links.

#### 1.6.1.5 CTR21 Compliant DAA

Components R10, R11, C11, D4, D5, U4 and U5 may be fitted to provide a 60mA current limit required by CTR21. An alternative wet line transformer, the Midcom 82107, must be fitted. Parts C10, C24, and R6 also have different values, to match the characteristics of the 82107 transformer and the CTR21 reference impedance.

### 1.6.1.6 Line Protection

Line protection is provided by the Sidactor component E1. Sidactor is the trade name for a type of Transient Voltage Suppressor (TVS) manufactured by Teccor Electronics.

### 1.6.1.7 Ring Detection

The ring detect threshold is approximately 20VRMS.

## 1.6.2 Serial Interface

The DE8661 can be controlled by sending AT commands over a direct serial interface from an external  $\mu$ Controller, or with a standard terminal emulator program running on a host PC, and connected via RS-232. This latter option makes use of the 9-pin D type socket and MAX3237 RS-232 Transceiver chip, both of which are fitted to one of the break-off sections of the DE8661 PCB. Asynchronous communication is used with 9600 baud, 8-bit words, no parity and 1 stop-bit. The 9600 baud rate necessitates CTS flow control to moderate the data rate. The CTS flow control method provided on the CMX866 will also work with the RTS/CTS handshake protocol used by some  $\mu$ Controllers.

If using an external  $\mu$ Controller to control the DE8661, its Request To Send signal should be taken low, which takes the CMX866 RTSN pin low. Data is asserted (AT commands or data), by the external  $\mu$ Controller onto the CMX866 TXD pin. When the DE8661 is ready to accept this data from the external host  $\mu$ Controller the CMX866 will take its CTSN pin low. The data should be sent as 8-bit bytes, encapsulated by a start bit (low) and a stop bit (high). The DE8661 should be presented with continuous mark (stop bits) when the external  $\mu$ Controller has no data to send. As each byte is received it is stored in an on-chip, 48-byte AT command buffer when in Command mode or in an on-chip, 16-byte receive data buffer when in Data Transfer mode. The CMX866 will take its CTSN pin high when either buffer is full and will ignore further information on the TXD pin until the on-chip  $\mu$ Controller is ready to accept it. At this time, the CMX866 will once again take its CTSN pin low to signify its readiness to accept more data, providing the RTSN pin is already low. If the external  $\mu$ Controller does not have a Request To Send signal, the RTSN pin should be permanently wired low. When RTSN is inactive high, CTSN follows RTSN and becomes inactive high, thus there is no data flow in either direction between the DE8661 and the external  $\mu$ Controller. As the incoming AT command is being interpreted, any phone number is identified and stored separately in the 24-byte on-chip phone number buffer.

When the DE8661 is in Data Transfer mode and a signal is received from the phone line exceeding the minimum amplitude threshold, the CMX866 will attempt to demodulate the signal and assert the received data on its RXD pin, after a complete byte has been demodulated. At the same time it will take its DCDN pin low. There is a 24-byte message buffer in the CMX866 receive path but, as the received data always arrives at slower than 9600 baud, there is no need for a flow control handshake in the receive path. It is assumed that the external  $\mu$ Controller will absorb all of the data presented to it without the need for flow control and will ignore continuous mark (stop bits) when there is no received data. If the received signal is below the detection threshold or the DE8661 is not in Data Transfer mode, the CMX866 will take its DCDN and RXD pins high.

If the CMX866 receives a RING signal on the RD and RT pins, such that the detection threshold is exceeded, then this condition will be signalled to the external  $\mu$ Controller by the CMX866 taking its RIN pin low. This pin follows the output of the ring detector, so will go low for each burst of RING signal. If the CMX866 is in a Powersave or 'Zero-Power' state, it will be woken up and the DSRN pin will go low once the on-chip  $\mu$ Controller is ready to receive communications through the serial port. This wake up process takes about 30ms from 'Zero-Power' state, as the VBIAS pin has to charge the external reservoir capacitor and the crystal oscillator has to start up

and stabilise before the CMX866 can initialise itself. From the Powersave state this wake up process takes about 10 $\mu$ s, as the oscillator and the VBIAS pin are already stable.

The CMX866 DSRN and DTRN pins do not act as a handshake with the external  $\mu$ Controller. The DSRN pin indicates the operational status of the on-chip  $\mu$ Controller (low = ready to communicate with an external  $\mu$ Controller). The DTRN pin is used for taking the CMX866 out of Powersave or 'Zero-Power' state. It effectively acts as a device wake up, in the same manner as the RING signal, and becomes active on the high to low transition. A high to low transition on the DTRN pin is ignored if the device is already 'woken up'. If the external  $\mu$ Controller does not have a DTR signal, the DTRN pin should be permanently wired to the TXD pin. When the CMX866 is in a Powersave or 'Zero-Power' state, the RXD, CTSN, DSRN, DCDN and RIN pins will be permanently high. The condition of the TXD, RTSN and DTRN pins is not important.

Depending on the &Dn configuration, if the DTRN pin on the CMX866 is taken high at any time whilst the DE8661 is in Data Transfer mode, a fixed, 100ms timeout is started. On completion of the timeout, the DE8661 will return to AT Command mode, enabling further AT commands to be sent. If the DTRN pin goes high whilst the DE8661 is in AT Command mode, the action is ignored. AT commands can be sent providing CTSN and RTSN are low (ie DTRN can be either high or low). A low to high transition on the ESC pin also has the same effect of returning the DE8661 from Data Transfer mode to Command mode, but with immediate effect. The &Dn command configures these options, see section 1.5.4.4 for more details.

If the RTSN pin of the CMX866 is taken high at any time whilst the DE8661 is in Data Transfer mode, a timeout is started whose value is set in the S28 register (0 = timeout disabled). On completion of the timeout, the DE8661 will return to AT Command mode and take CTSN high. If the RTSN pin goes high whilst the DE8661 is in AT Command mode, the CTSN pin goes high and the action on the RTSN pin is ignored. Information transfer can only restart when the RTSN pin is taken low again and the CMX866 responds by taking CTSN low.

### 1.6.3 Reset Function

The CMX866 as fitted to the DE8661 has an internal power-up reset function which is activated whenever power is applied to the board. This reset function resets all of the on-chip  $\mu$ Controller registers, including the S-Register settings, and then performs an initialisation sequence which resets the internal DSP and subsequently places it in a powersave state, loads the factory default values into the S-Registers and places the on-chip  $\mu$ Controller into an operating state. This internal power-up reset function is OR-ed with the RESETN pin.

When the RESETN pin is taken low, i.e. SW1 on the break-off section is activated or a low signal is applied to pin 24 of the DE8661 the reset operation described above is performed.

When the CMX866 first enters the operating state, it reports its configuration as follows:

- CMX866 waits for DTRN to go active (low) - to wake up the device
- CMX866 takes the DSRN pin active (low) to indicate its readiness to communicate with an external  $\mu$ Controller
- CMX866 waits for RTSN to go active (low)
- CMX866 sends "CMX866" identification message to external  $\mu$ Controller (equivalent to the external  $\mu$ Controller issuing an ATIO command)
- The on-chip  $\mu$ Controller now powers up the DSP part of the CMX866
- The DSP is automatically reset then requested to perform an internal diagnostic self-check, which takes about 2.9ms to complete
- On successful completion, CMX866 sends "DSP checksum OK" identification message to the external  $\mu$ Controller. If not successful, CMX866 sends "DSP Error" message to the

external  $\mu$ Controller. In the latter case, the CMX866 should be reset again by taking the RESETN pin low

- The on-chip  $\mu$ Controller now powers down the DSP part of the CMX866
- The on-chip  $\mu$ Controller is now in the Command mode operating state and is ready to accept AT commands from the serial interface, approximately 55ms after DTRN goes low
- CMX866 takes the CTSN pin active (low) to indicate its readiness to communicate with an external  $\mu$ Controller

### 1.6.4 AT Command and S-Register Summary

AT Command	Parameters	Function	Default
A		Answer Command - Answer and establish a connection when off-hook	
A/		Re-execute last command	
Bn	n = 0..9	Select Communications Standard <b>(Mapped to S27)</b> n = 0 V.22bis 2400bps QAM n = 1 V.22 1200bps DPSK n = 2 V.23 Tx 75bps, Rx 1200bps (Master) n = 3 V.23 Tx 1200bps, Rx 75bps(Slave) n = 4 Reserved n = 5 V.21 300bps FSK n = 6 Bell 212A 1200bps DPSK n = 7 Bell 202 Tx 150bps Rx 1200bps n = 8 Bell 202 Tx 1200bps Rx 150bps n = 9 Bell 103 300bps FSK	n=0
Dn ... n or DTn ... n	n = 0..9, A..D, *,# , ! ;	Dial Command - DTMF dials the subsequent Directory Number Dial Command Modifier - Delay during dialling - time in S8 register Dial Command Modifier- Send a line break - time in S29 register Dial Command Modifier - command mode after dialling, no handshake	
DL		Dial Command - Redial last number	
En	n = 0,1	Command echo, 0=off, 1=on	n=1
Hn	n = 0,1	Switch Hook Control, 0=on-hook, 1=off-hook	n=0
In	n = 0	Identification - Returns the modem's product identification	
Nn	n = 0,1	V.22bis Fallback to V.22 option, 0=none, 1=automatic	n=1
O		Go online in Data mode (from Command mode)	
Qn	n = 0,1	Enable(n=0)/Disable(n=1) return of modem result codes	n=0
RO		Execute V.23 or Bell 202 turnaround if enabled (see S14 and S24) then go online in Data mode	
AT Command	Parameters	Function	Default
Sn?	n = 0..29	S-Register "n" Read - Display specified S Register contents	
Sn=x	n = 0..29	S-Register "n" Write - Write to specified S Register	
Vn	n =0,1	Return result codes as numbers (n=0) or words (n=1)	n=0
Xn	n = 0..3	Calling and Response Characteristics	n=3
Z		Restore factory profile for CMX866	
&Cn	n = 0,1	DCD always on (n=0) or DCD follows carrier (n=1)	n=1
&Dn	n= 0..2	DTR signal procedure	n=2
&Gn	n = 0..2	Guard Tone Select - Disable (n=0), Enable 550Hz (n=1) or 1800Hz (n=2)	n=0
&Tn	n = 0,3..6	User accessible Loopback Tests and Diagnostics	n=0
&V		Returns current configuration	
&Zn	n = 0,1	'Zero-Power' state (n=0) or Powersave state (n=1)	
@Rn?	n = 00..FF	DSP Register "n" Read - Display specified DSP Register contents	
@Rn=x	n = 00..FF	DSP Register "n" Write - Write to specified DSP Register	

S Registers	Parameters	Function	Default
S0	0...255	Number of rings before answering, 0 = Auto-answer disabled	2
S1	0...255	Number of rings received	0
S2	0-127	Escape character value	+
S3	0-127	Carriage return character value	CR
S4	0-127	Line feed character value	LF
S5	0-127	Backspace character value	BS
S6	2...255	Waiting time in seconds for dial tone or before blind dialling	4s
S7	2...255	Maximum waiting time in seconds for carrier	50s
S8	0...255	Pause time in seconds for "," dial modifier	2s
S9	1...255	Reserved	
S10	1...255	Lost carrier to hang up delay in units of 100ms	700ms
S11	5...255	DTMF tone duration and interdigit pause duration in units of 10ms	100ms
S12	0...255	Escape code guard time in units of 50ms	1s
S13		Reserved	
S14	0...255	General Options: bypass Answer Tone Detect sequence for 'Fast Connect'	\$92
S15	0...255	Loopback carrier off time in milliseconds	80ms
S16	0...255	Drop time for loopback in milliseconds	60ms
S17	0...255	Handshake timeout (Answering) in seconds	30s
S18	0...255	Loopback timer (0= no timeout) in seconds	0s
S19		Reserved for test functions	
S20		Reserved	
S21	0...255	Loopback and Power states	\$10
S22	0...255	Calling and response characteristics selection	\$C0

S Registers	Parameters	Function	Default
S23	0...255	Guard tone selection	\$00
S24	0...255	Equaliser, DCD, DTR status and modulation fallback	\$A9
S25	0...255	Tx Gain, Tx data format	\$B0
S26	0...255	Rx Gain, Rx data format, overspeed (2.3% default) setting	\$30
S27	0...255	Communications Protocol	\$00
S28	0...255	RTSN Timeout for return to Command mode from Data mode in seconds	0s
S29	0...255	Timed Break Recall period in centiseconds	300ms

Xn Register	Parameter	Calling and Response Characteristics
	<b>n</b>	<b>(Mapped to S22 register)</b>
	0	Ignore dial tones and busy tones, return CONNECTxxxx or NO CARRIER
	1	Ignore busy tone, wait for dial tone to dial. Return NO DIAL TONE or CONNECT xxxx or NO CARRIER
	2	Ignore dial tone. If busy tone detected, return BUSY. Return CONNECT xxxx
	3	Return NO DIAL TONE, BUSY, CONNECT xxxx, or NO CARRIER

&Dn Register	Parameter	DTR action
	<b>n</b>	<b>(Mapped to S24 register)</b>
	0	Ignore DTR signal
	1	Go to command state when on to off transition occurs
	2	Hang up and go to command state when on to off transition occurs

&Gn Register	Parameter	Guard Tone action
	<b>n</b>	<b>(Mapped to S23 register)</b>
	0	Disabled
	1	Enabled 550Hz
	2	Enabled 1800Hz

&Tn Register	Parameter	Test function
	<b>n</b>	<b>(Mapped to S21 register)</b>
	0	Terminate test
	1	Reserved
	2	Reserved
	3	Local digital loopback
	4	Enable remote request for digital loopback
	5	Disable remote request for digital loopback
	6	Request remote digital loopback & initiate

### 1.6.5 General Description of AT Commands

Supported AT commands are listed in section 1.6.4. Valid commands will generate an 'OK' result code (see section 1.6.6) and invalid commands will be rejected with an 'ERROR' result code, when command echoing and word result codes are enabled. The CMX866 will send a <LF> character directly after a <CR> character to ensure compatibility with external  $\mu$ Controllers. Any commands which are not fully implemented will return the result code 'NYI' (Not Yet Implemented). AT commands should not be sent to the on-chip  $\mu$ Controller until the previous result code (if enabled) has been received.

Each command line (except for A/ and the escape sequence) must begin with the AT prefix and be terminated with a carriage return <CR>. The CMX866 waits to receive a complete AT command line before processing it. Embedded spaces are ignored and the case (upper or lower) of characters including the 'AT' does not matter. The command line must not exceed 48 characters (excluding the 'AT' characters). The CMX866 will ignore the command line and return an 'ERROR' result code if the line is not terminated correctly.

All characters in the AT command, including the 'AT' and <CR> terminator are echoed (if E1 is set) by the DE8661 in the order in which they are sent by the external  $\mu$ Controller.

If when entering an AT command, no command or register name suffix is supplied, a suffix of zero is assumed. If when changing a register value, no value is supplied a value of zero or an empty string is assumed, i.e. `ATS0=<CR>` is equivalent to `ATS0=0<CR>`.

Receipt of a back space will cause the DE8661 to send a "backspace, space, backspace" sequence of characters to the external  $\mu$ Controller, to allow any terminal which may be connected to the latter to clear its screen of the last character. Also the last character received will be discarded unless the last characters received were 'AT', ie the 'AT' is never deleted.

The escape sequence '+++ ' (with Guard Time = 1s [see S12 register] before and after the sequence) will cause the DE8661 to enter AT Command mode from Data Transfer mode and to return an 'OK' response.

A detailed description of AT commands and S-Registers can be found in the CMX866 Data Sheet, available from the CML website.

### 1.6.6 Modem Result Codes

<i>Numeric Response (Decimal)</i>	<i>Alpha Response</i>	
00	OK	
01	CONNECT	
02	RING	
03	NO CARRIER	
04	ERROR	
05	NO DIAL TONE	
06	BUSY	
07	CONNECT 2400	
08	CONNECT 1200	
09	DUAL TONE DETECT	
10	CONNECT 300	
11	CONNECT 1200/75	
12	CONNECT 75/1200	
13	CONNECT 1200/150	
14	CONNECT 150/1200	
15	NYI	(Not Yet Implemented)

### 1.6.7 Terminal Emulator

If using a terminal emulator to control the DE8661, 'HyperTerminal', which is supplied with the Windows 95/NT installations, is suitable for this purpose.

#### HyperTerminal Setup

Emulation VT100

ASCII Character set

ASCII Receiving:

Wrap lines that exceed terminal width.

COM Port Settings:

Bits per second	9600
Data bits	8
Parity	None
Stop bits	1
Flow Control	Hardware

Some terminal emulators have been found not to support full hardware flow control when transferring text files. This could result in data loss when using this facility. If this problem is experienced users should try using a different terminal emulator.

To ensure successful negotiation and data transfer between the DE8661 and third party modems, users should ensure their third party modem is configured to the correct protocol (see third party AT command documentation).

Note, any sudden loss of the 2-wire line during data transfer will result in loss of carrier and therefore the demonstration board will hang up and display the NO CARRIER message. However, due to the lost carrier to hang up delay (S10), a short burst of corrupt characters (noise generated) will be observed on the HyperTerminal window before the NO CARRIER message is displayed. These corrupt characters can sometimes match control characters and therefore modify HyperTerminal's behaviour. The user is advised to restart HyperTerminal if this happens.

## 1.7 Performance Specification

### 1.7.1 Electrical Performance

#### 1.7.1.1 Absolute Maximum Ratings

Exceeding these maximum ratings can result in damage to the DE8661.

	Min.	Max.	Units
Supply ( $V_{DD} - V_{SS}$ )	-0.3	7.0	V
Voltage on any connector pin to $V_{SS}$	-0.3	$V_{DD} + 0.3$	V
Current into or out of any socket modem connector pin other than $V_{DD}$ , $V_{SS}$ , TIP and RING	-20	+20	mA

#### 1.7.1.2 Operating Limits

Correct operation of the DE8661 outside these limits is not implied.

	Notes	Min.	Max.	Units
Supply ( $V_{DD} - V_{SS}$ )		2.7	5.5	V

#### 1.7.1.3 Operating Characteristics

For the following conditions unless otherwise specified:

Evaluation Device Xtal Frequency = 11.0592MHz  $\pm$ 0.01% (100ppm)  
 $V_{DD}$  = 3.0V or 5.0V,  $T_{amb}$  = +25°C.

	Notes	Min.	Typ.	Max.	Units
<b>DC Parameters</b>					
$I_{DD}$ (socket modem alone - idle)			10		mA
$I_{DD}$ (demonstration board - idle)	1		18		mA

**Notes:** 1. Hook LED off



CML does not assume any responsibility for the use of any circuitry described. No IPR or circuit patent licences are implied. CML reserves the right at any time without notice to change the said circuitry and any part of this product specification. Evaluation kits and demonstration boards are supplied for the sole purpose of demonstrating the operation of CML products and are supplied without warranty. They are intended for use in a laboratory environment only and are not for re-sale, end-use or incorporation into other equipments. Operation of these kits and boards outside a laboratory environment is not permitted within the European Community. All software/firmware is supplied "as is" and is without warranty. It forms part of the product supplied and is licensed for use only with this product, for the purpose of demonstrating the operation of CML products. Whilst all reasonable efforts are made to ensure that software/firmware contained in this product is virus free, CML accepts no responsibility whatsoever for any contamination which results from using this product and the onus for checking that the software/firmware is virus free is placed on the purchaser of this evaluation kit or development board.

**[www.cmlmicro.com](http://www.cmlmicro.com)**

**For FAQs see:** [www.cmlmicro.com/products/faqs/](http://www.cmlmicro.com/products/faqs/)

**For a full data sheet listing see:** [www.cmlmicro.com/products/datasheets/download.htm](http://www.cmlmicro.com/products/datasheets/download.htm)

**For detailed application notes:** [www.cmlmicro.com/products/applications/](http://www.cmlmicro.com/products/applications/)

 <b>CML Microcircuits (UK) Ltd</b>	 <b>CML Microcircuits (USA) Inc.</b>	 <b>CML Microcircuits (Singapore) Pte Ltd</b>	
Oval Park, Langford, Maldon, Essex, CM9 6WG - England.  Tel: +44 (0)1621 875500 Fax: +44 (0)1621 875600  Sales: <a href="mailto:sales@cmlmicro.com">sales@cmlmicro.com</a>  Technical Support: <a href="mailto:techsupport@cmlmicro.com">techsupport@cmlmicro.com</a>	4800 Bethania Station Road, Winston-Salem, NC 27105 - USA.  Tel: +1 336 744 5050, 800 638 5577 Fax: +1 336 744 5054  Sales: <a href="mailto:us.sales@cmlmicro.com">us.sales@cmlmicro.com</a>  Technical Support: <a href="mailto:us.techsupport@cmlmicro.com">us.techsupport@cmlmicro.com</a>	No 2 Kallang Pudding Road, #09 - 05/06 Mactech Industrial Building, Singapore 349307  Tel: +65 6745 0426 Fax: +65 6745 2917  Sales: <a href="mailto:sg.sales@cmlmicro.com">sg.sales@cmlmicro.com</a>  Technical Support: <a href="mailto:sg.techsupport@cmlmicro.com">sg.techsupport@cmlmicro.com</a>	No. 218, Tian Mu Road West, Tower 1, Unit 1008, Shanghai Kerry Everbright City, Zhabei, Shanghai 200070, China.  Tel: +86 21 6317 4107 +86 21 6317 8916 Fax: +86 21 6317 0243  Sales: <a href="mailto:cn.sales@cmlmicro.com.cn">cn.sales@cmlmicro.com.cn</a>  Technical Support: <a href="mailto:sg.techsupport@cmlmicro.com">sg.techsupport@cmlmicro.com</a>