

Features

- Diffused Junction
- Fast Switching for High Efficiency
- High Current Capability and Low Forward Voltage Drop
- Surge Overload Rating to 50A Peak
- Low Reverse Leakage Current
- **Lead Free Finish, RoHS Compliant (Note 4)**

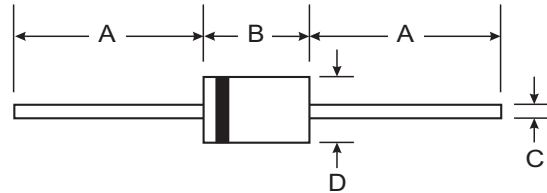

Mechanical Data

- Case: DO-41, DO-15
- Case Material: Molded Plastic. UL Flammability Classification Rating 94V-0
- Moisture Sensitivity: Level 1 per J-STD-020C
- Terminals: Finish - Bright Tin. Plated Leads Solderable per MIL-STD-202, Method 208
- Polarity: Cathode Band
- Ordering Information: See Last Page
- Marking: Type Number
- DO-41 Weight: 0.3 grams (approximate)
- DO-15 Weight: 0.4 grams (approximate)

Dim	DO-41 Plastic		DO-15	
	Min	Max	Min	Max
A	25.40	—	25.40	—
B	4.06	5.21	5.50	7.62
C	0.71	0.864	0.686	0.889
D	2.00	2.72	2.60	3.60
All Dimensions in mm				

“S” Suffix Designates DO-41 Package
No Suffix Designates DO-15 Package

Maximum Ratings and Electrical Characteristics @ T_A = 25°C unless otherwise specified

Single phase, half wave, 60Hz, resistive or inductive load.
For capacitive load, derate current by 20%.

Characteristic	Symbol	PR 1501/S	PR 1502/S	PR 1503/S	PR 1504/S	PR 1505/S	Unit
Peak Repetitive Reverse Voltage Working Peak Reverse Voltage DC Blocking Voltage	V _{RRM} V _{RWM} V _R	50	100	200	400	600	V
RMS Reverse Voltage	V _{R(RMS)}	35	70	140	280	420	V
Average Rectified Output Current (Note 1) @ T _A = 50°C	I _O	1.5					A
Non-Repetitive Peak Forward Surge Current 8.3ms Single half sine-wave Superimposed on Rated Load (JEDEC Method)	I _{FSM}	50					A
Forward Voltage @ I _F = 1.5A	V _{FM}	1.2					V
Peak Reverse Current @ T _A = 25°C at Rated DC Blocking Voltage @ T _A = 100°C	I _{RM}	5.0 100					μA
Reverse Recovery Time (Note 3)	t _{rr}	150				250	ns
Typical Junction Capacitance (Note 2)	C _j	20				10	pF
Typical Thermal Resistance Junction to Ambient	R _{θJA}	35					K/W
Operating and Storage Temperature Range	T _j , T _{STG}	-65 to +150					°C

- Notes:
1. Valid provided that leads are maintained at ambient temperature at a distance of 9.5mm from the case.
 2. Measured at 1.0MHz and applied reverse voltage of 4.0V DC.
 3. Measured with I_F = 0.5A, I_R = 1.0A, I_{rr} = 0.25A. See figure 5.
 4. RoHS revision 13.2.2003. Glass and High Temperature Solder Exemptions Applied, see EU Directive Annex Notes 5 and 7.

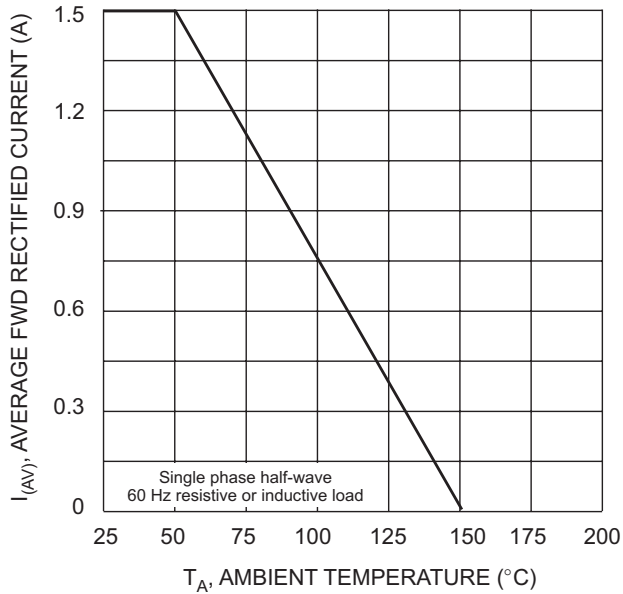

Fig. 1 Forward Derating Curve

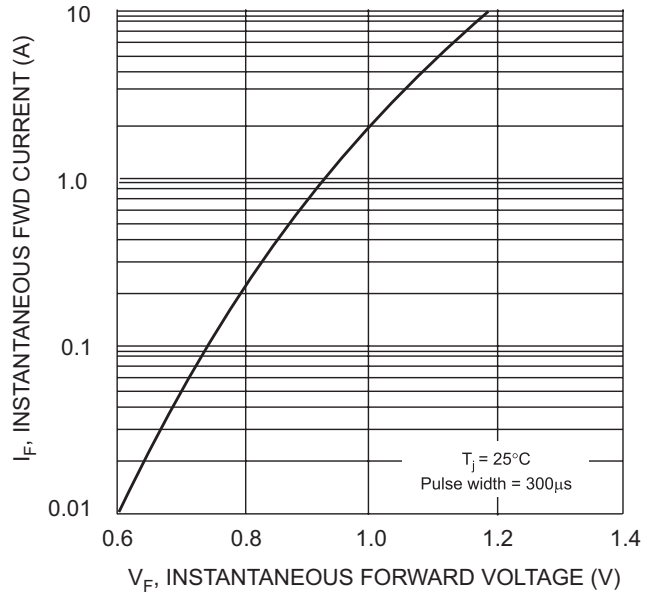

Fig. 2 Typical Forward Characteristics

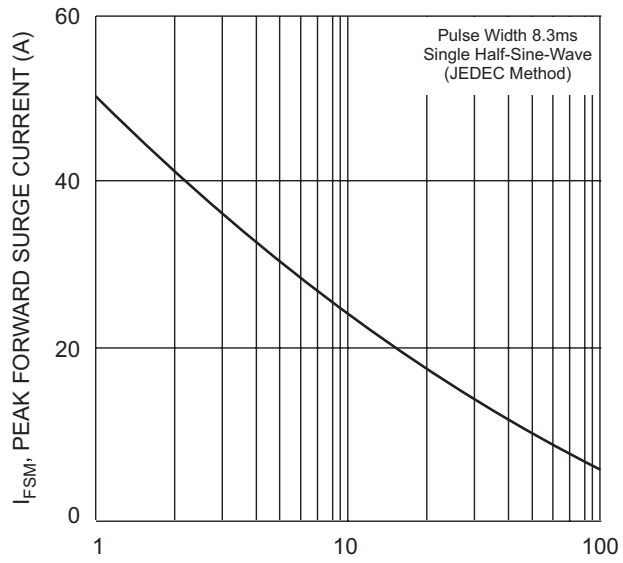

Fig. 3 Peak Forward Surge Current

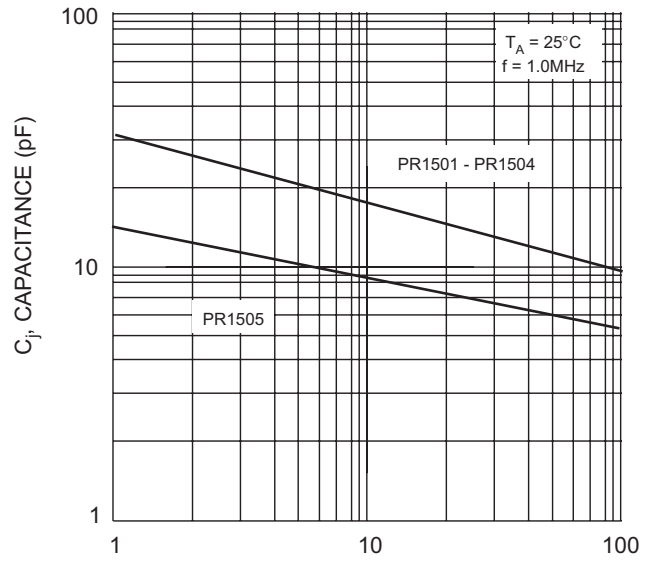
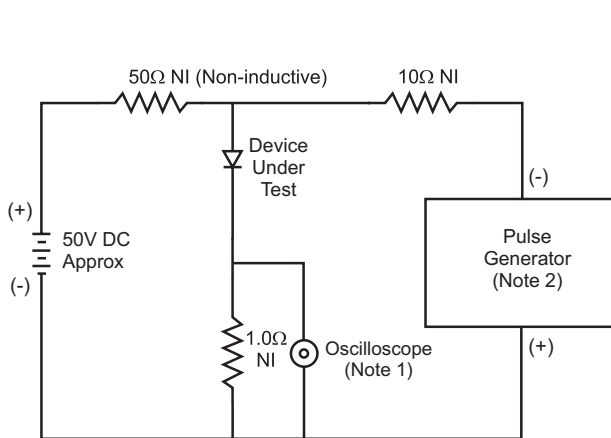
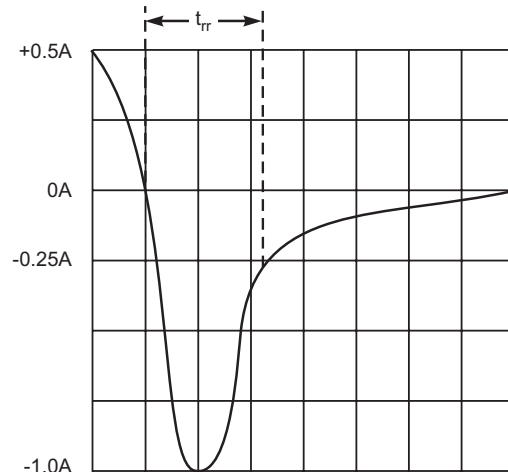

Fig. 4 Typical Junction Capacitance



- Notes:
1. Rise Time = 7.0ns max. Input Impedance = 1.0MΩ, 22pF.
 2. Rise Time = 10ns max. Input Impedance = 50Ω.



Set time base for 50/100 ns/cm

Fig. 5 Reverse Recovery Time Characteristic and Test Circuit

Ordering Information (Note 5)

Device	Packaging	Shipping
PR1501S-A	DO-41	5K/Ammo Pack
PR1501S-B	DO-41	1K/Bulk
PR1501S-T	DO-41	5K/Tape & Reel, 13-inch
PR1502S-A	DO-41	5K/Ammo Pack
PR1502S-B	DO-41	1K/Bulk
PR1502S-T	DO-41	5K/Tape & Reel, 13-inch
PR1503S-A	DO-41	5K/Ammo Pack
PR1503S-B	DO-41	1K/Bulk
PR1503S-T	DO-41	5K/Tape & Reel, 13-inch
PR1504S-A	DO-41	5K/Ammo Pack
PR1504S-B	DO-41	1K/Bulk
PR1504S-T	DO-41	5K/Tape & Reel, 13-inch
PR1505S-A	DO-41	5K/Ammo Pack
PR1505S-B	DO-41	1K/Bulk
PR1505S-T	DO-41	5K/Tape & Reel, 13-inch
PR1501-B	DO-15	1K/Bulk
PR1501-T	DO-15	4K/Tape & Reel, 13-inch
PR1502-B	DO-15	1K/Bulk
PR1502-T	DO-15	4K/Tape & Reel, 13-inch
PR1503-B	DO-15	1K/Bulk
PR1503-T	DO-15	4K/Tape & Reel, 13-inch
PR1504-B	DO-15	1K/Bulk
PR1504-T	DO-15	4K/Tape & Reel, 13-inch
PR1505-B	DO-15	1K/Bulk
PR1505-T	DO-15	4K/Tape & Reel, 13-inch

Notes: 5. For packaging details, visit our website at <http://www.diodes.com/datasheets/ap02008.pdf>