

## FEATURES

- **Input Voltage Range: 2.4V to 6V**
- **Fixed Output Voltages: 1.8V  $\pm$ 4%, 2V  $\pm$ 4%**
- **Output Current: Up to 100mA**
- **No Inductors**
- **Typical Efficiency 25% Higher than LDOs**
- **Low Operating Current: 25 $\mu$ A**
- **Low Shutdown Current: 5 $\mu$ A**
- 600kHz Switching Frequency
- Shutdown Disconnects Load from  $V_{IN}$
- Soft-Start Limits Inrush Current at Turn-On
- Short-Circuit and Overtemperature Protected
- Available in 8-Pin MSOP and SO Packages

## APPLICATIONS

- Cellular Phones
- Handheld Computers
- Smart Card Readers
- Low Power DSP Supplies
- Portable Electronic Equipment
- Handheld Medical Instruments

## DESCRIPTION

The LTC<sup>®</sup>1503-1.8/LTC1503-2 are switched capacitor step-down DC/DC converters that produce a regulated output from a 2.4V to 6V input. The parts use switched capacitor fractional conversion to achieve high efficiency over the entire input range. No inductors are required. Internal circuitry controls the step-down conversion ratio to optimize efficiency as the input voltage and load conditions vary. Typical efficiency is 25% higher than that of a low dropout (LDO) linear regulator.

Regulation is achieved by sensing the output voltage and enabling the internal switching network as needed to maintain a fixed output voltage. This method of regulation enables the parts to achieve high efficiency at extremely light loads. Low operating current (25 $\mu$ A with no load, 5 $\mu$ A in shutdown) and low external parts count (two 1 $\mu$ F flying capacitors and two 10 $\mu$ F bypass capacitors) make the LTC1503-1.8/LTC1503-2 ideally suited for space constrained battery-powered applications. The parts are fully short-circuit and overtemperature protected.

The LTC1503-1.8/LTC1503-2 are available in 8-pin MSOP and SO packages.

 LTC and LT are registered trademarks of Linear Technology Corporation.

## TYPICAL APPLICATION

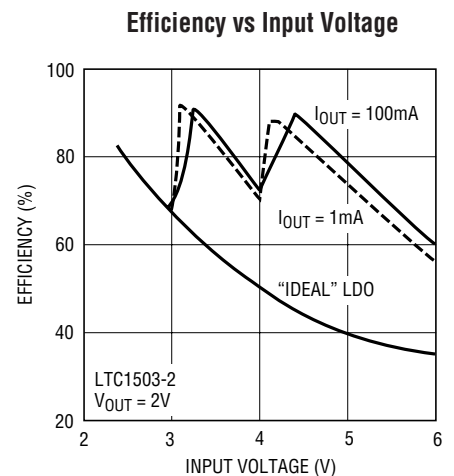
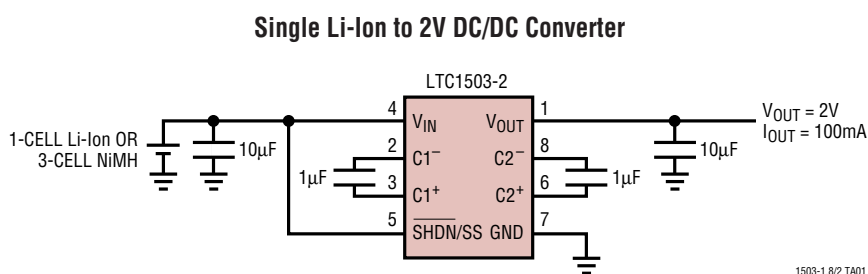

# LTC1503-1.8/LTC1503-2

## ABSOLUTE MAXIMUM RATINGS (Note 1)

$V_{IN}$ , $C1^+$ , $C1^-$ , $C2^+$ , $C2^-$ to GND .....	-0.3V to 6.5V	Industrial Temperature Range .....	-40°C to 85°C
$\overline{SHDN/SS}$ to GND .....	-0.3V to ( $V_{IN} + 0.3V$ )	Specified Temperature Range (Note 2) ...	-40°C to 85°C
$V_{OUT}$ Short-Circuit Duration .....	Indefinite	Storage Temperature Range .....	-65°C to 150°C
Commercial Temperature Range .....	-40°C to 85°C	Lead Temperature (Soldering, 10 sec) .....	300°C

## PACKAGE/ORDER INFORMATION

<p>MS8 PACKAGE 8-LEAD PLASTIC MSOP <math>T_{JMAX} = 125^{\circ}C</math>, <math>\theta_{JA} = 200^{\circ}C/W</math></p>	ORDER PART NUMBER	<p>S8 PACKAGE 8-LEAD PLASTIC SO <math>T_{JMAX} = 125^{\circ}C</math>, <math>\theta_{JA} = 150^{\circ}C/W</math></p>	ORDER PART NUMBER
	LTC1503CMS8-1.8 LTC1503CMS8-2		LTC1503CS8-1.8 LTC1503CS8-2 LTC1503IS8-1.8 LTC1503IS8-2
	MS8 PART MARKING		S8 PART MARKING
	LTFX LTHN		150318 503118 15032 150312

Consult factory for Military grade parts.

## ELECTRICAL CHARACTERISTICS

The ● denotes specifications which apply over the full operating temperature range, otherwise specifications are at  $T_A = 25^{\circ}C$ .  
 $V_{IN} = V_{IN(MIN)}$  to  $V_{IN(MAX)}$ ,  $C1 = C2 = 1\mu F$ ,  $C_{IN} = C_{OUT} = 10\mu F$  unless otherwise noted.

PARAMETER	CONDITIONS	MIN	TYP	MAX	UNITS
$V_{IN}$ Operating Voltage		● 2.4		6	V
$V_{OUT}$	LTC1503-1.8, $0mA < I_{OUT} < 100mA$	● 1.728	1.8	1.872	V
	LTC1503-2, $0mA < I_{OUT} < 100mA$	● 1.920	2.0	2.080	V
$V_{IN}$ Operating Current	$I_{OUT} = 0mA$	●	25	50	$\mu A$
$V_{IN}$ Shutdown Current	$\overline{SHDN/SS} = 0V$	●	5	10	$\mu A$
Output Ripple Voltage	LTC1503-X, $V_{IN} = 3.6V$ , $I_{OUT} = 100mA$		25		mV <sub>p-p</sub>
Efficiency	LTC1503-2, $V_{IN} = 3.6V$ , $I_{OUT} = 100mA$		82.9		%
Switching Frequency	Oscillator Free Running		600		kHz
$\overline{SHDN/SS}$ Input Threshold		● 0.2	0.35	0.5	V
$\overline{SHDN/SS}$ Input Current	$V_{\overline{SHDN/SS}} = 0V$ (Note 3)	● -3.5	-2	-1	$\mu A$
	$V_{\overline{SHDN/SS}} = V_{IN}$	● -1		1	$\mu A$
$V_{OUT}$ Short-Circuit Current	$V_{OUT} = 0V$ (Note 4)	● 8	22	50	mA
$V_{OUT}$ Turn-On Time	$C_{SS} = 0nF$ , $V_{IN} = 3.6V$ , $C_{OUT} = 10\mu F$ $C_{SS} = 10nF$		0.1		ms
			8		ms

**Note 1:** Absolute Maximum Ratings are those values beyond which the life of a device may be impaired.

**Note 2:** The LTC1503C is guaranteed to meet specified performance from 0°C to 70°C and is designed, characterized and expected to meet these extended temperature limits, but are not tested at -40°C and 85°C. The LTC1503I is guaranteed to meet the extended temperature limits.

**Note 3:** Currents flowing into the device are positive polarity. Currents flowing out of the device are negative polarity.

**Note 4:** When  $V_{OUT}$  is less than 150mV,  $I_{OUT}$  is limited to much less than the maximum rated output current to prevent damage to the output devices.

# TYPICAL PERFORMANCE CHARACTERISTICS

**LTC1503-X Input Operating Current vs Input Voltage**

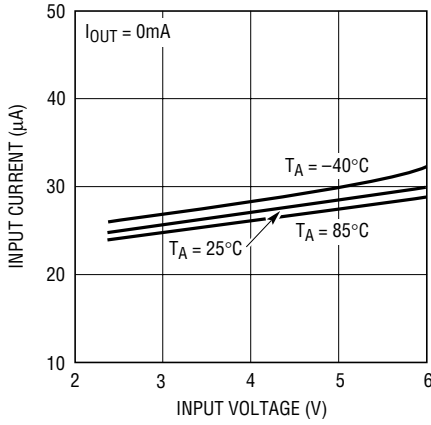

1503 G01

**LTC1503-X Input Shutdown Current vs Input Voltage**

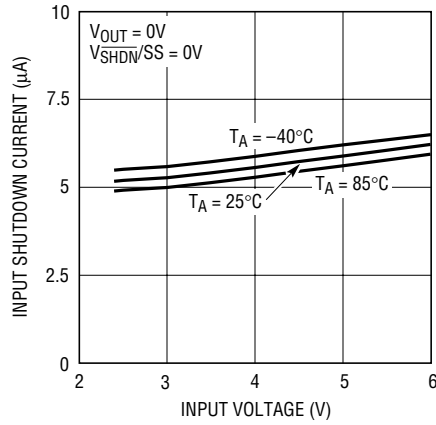

1503-1.8/2 TA02

**LTC1503-1.8 Output Voltage vs Input Voltage**

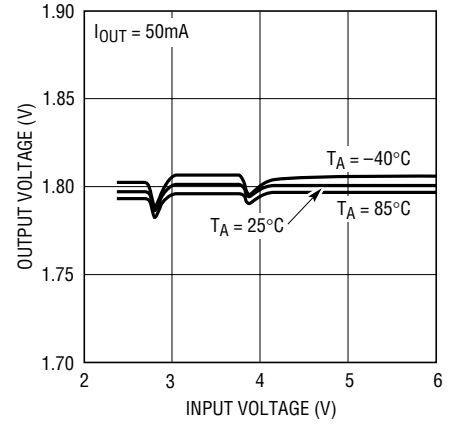

1503-1.8/2 G03

**LTC1503-2 Output Voltage vs Input Voltage**

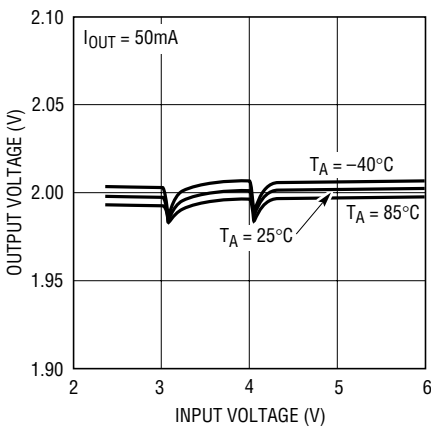

1503 G03

**LTC1503-1.8 Efficiency vs Input Voltage**

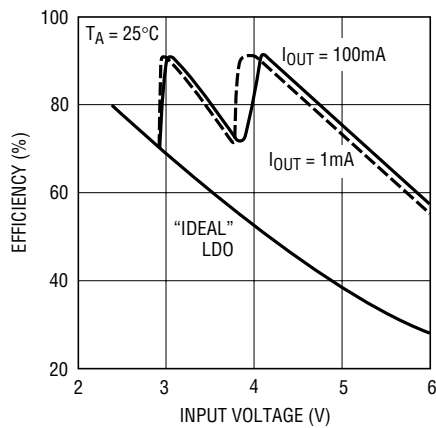

1503-1.8/2 G05

**LTC1503-1.8 Efficiency vs Output Current**

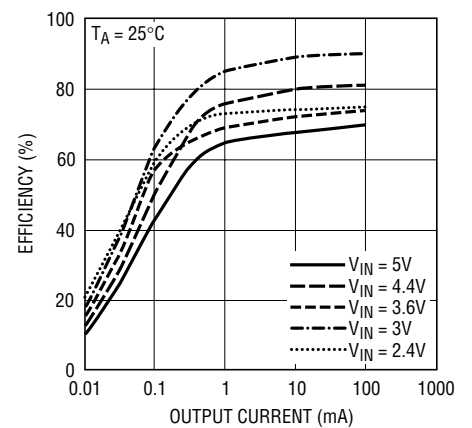

1503-1.8/2 G06

**LTC1503-2 Efficiency vs Output Current**

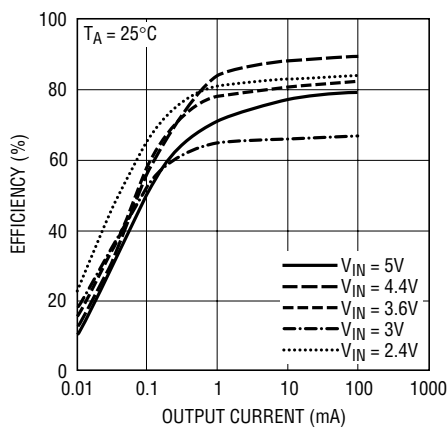

1503-1.8/2 G07

**LTC1503-1.8 Output Voltage vs Output Current**

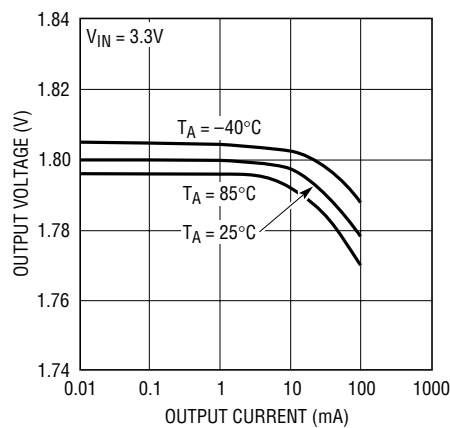

1503-1.8/2 G08

**LTC1503-2 Output Voltage vs Output Current**

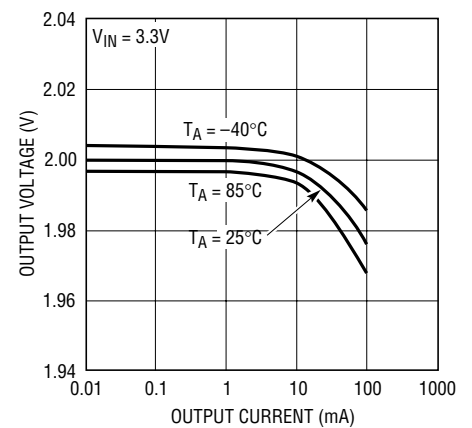

1503-1.8/2 G09

## TYPICAL PERFORMANCE CHARACTERISTICS

**LTC1503-X Output Short-Circuit Current vs Input Voltage**

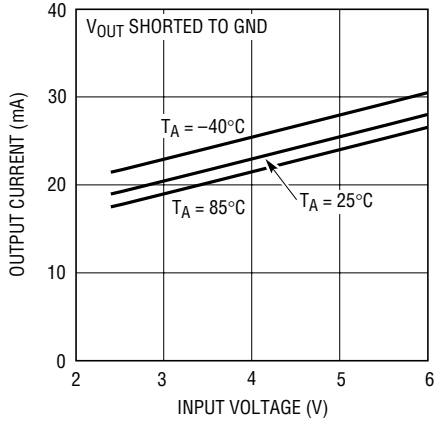

1503-1.8/2 G10

**LTC1503-X Start-Up Time vs Soft-Start Capacitor**

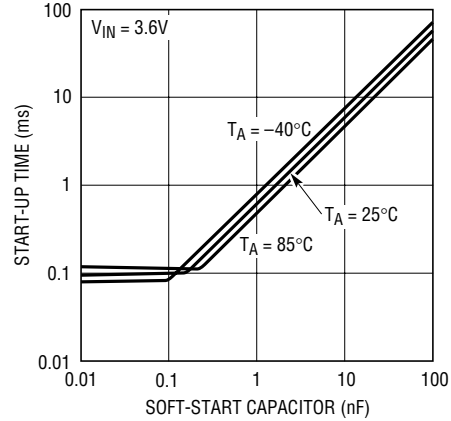

1503-1.8/2 G10

**Output Load Transient Response (LTC1503-1.8, 1mA to 100mA Step)**

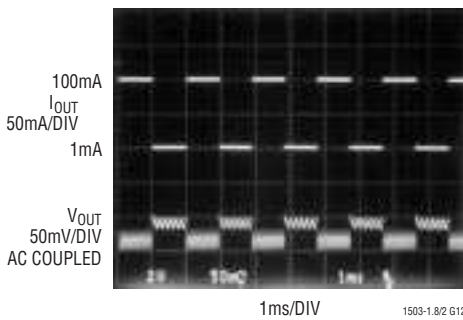

1503-1.8/2 G12

**Output Ripple,  $C_{OUT} = 10\mu\text{F}$**

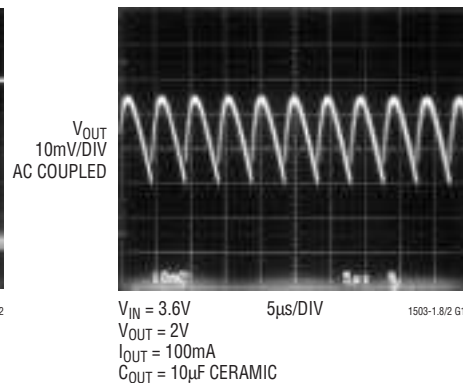

1503-1.8/2 G13

**Output Ripple,  $C_{OUT} = 22\mu\text{F}$**

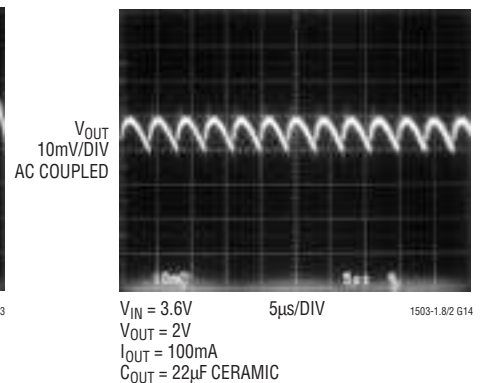

1503-1.8/2 G14

## PIN FUNCTIONS

**$V_{OUT}$  (Pin 1):** Regulated Output Voltage.  $V_{OUT}$  is disconnected from  $V_{IN}$  during shutdown. Bypass  $V_{OUT}$  to ground with a  $\geq 10\mu\text{F}$  low ESR capacitor.

**$C1^-$  (Pin 2):** Flying Capacitor One Negative Terminal.

**$C1^+$  (Pin 3):** Flying Capacitor One Positive Terminal.

**$V_{IN}$  (Pin 4):** Input Voltage.  $V_{IN}$  may be between 2.4V and 6V. Bypass  $V_{IN}$  to ground with a  $\geq 10\mu\text{F}$  low ESR capacitor.

**$\overline{\text{SHDN/SS}}$  (Pin 5):** Shutdown/Soft-Start Control. The pin is designed to be driven with an external open-drain

output. Holding the  $\overline{\text{SHDN/SS}}$  pin below 0.25V will force the part into shutdown mode. An internal pull-up current of 2 $\mu\text{A}$  will force the  $\overline{\text{SHDN/SS}}$  voltage to climb to  $V_{IN}$  once the device driving the pin is forced into a Hi-Z state. To limit inrush current on start-up, connect a capacitor between the  $\overline{\text{SHDN/SS}}$  pin and ground. Capacitance on the  $\overline{\text{SHDN/SS}}$  pin will limit the  $dV/dt$  of the pin during turn-on which, in turn, will limit the  $dV/dt$  of  $V_{OUT}$ . By selecting an appropriate soft-start capacitor for a known output capacitor, the user can control the inrush current during

## PIN FUNCTIONS

turn-on (see Applications Information). If neither of the two functions are desired, the pin may be floated or tied to  $V_{IN}$ .

**C2<sup>+</sup> (Pin 6):** Flying Capacitor Two Positive Terminal.

**GND (Pin 7):** Ground. Connect to a ground plane for best performance.

**C2<sup>-</sup> (Pin 8):** Flying Capacitor Two Negative Terminal.

## BLOCK DIAGRAM

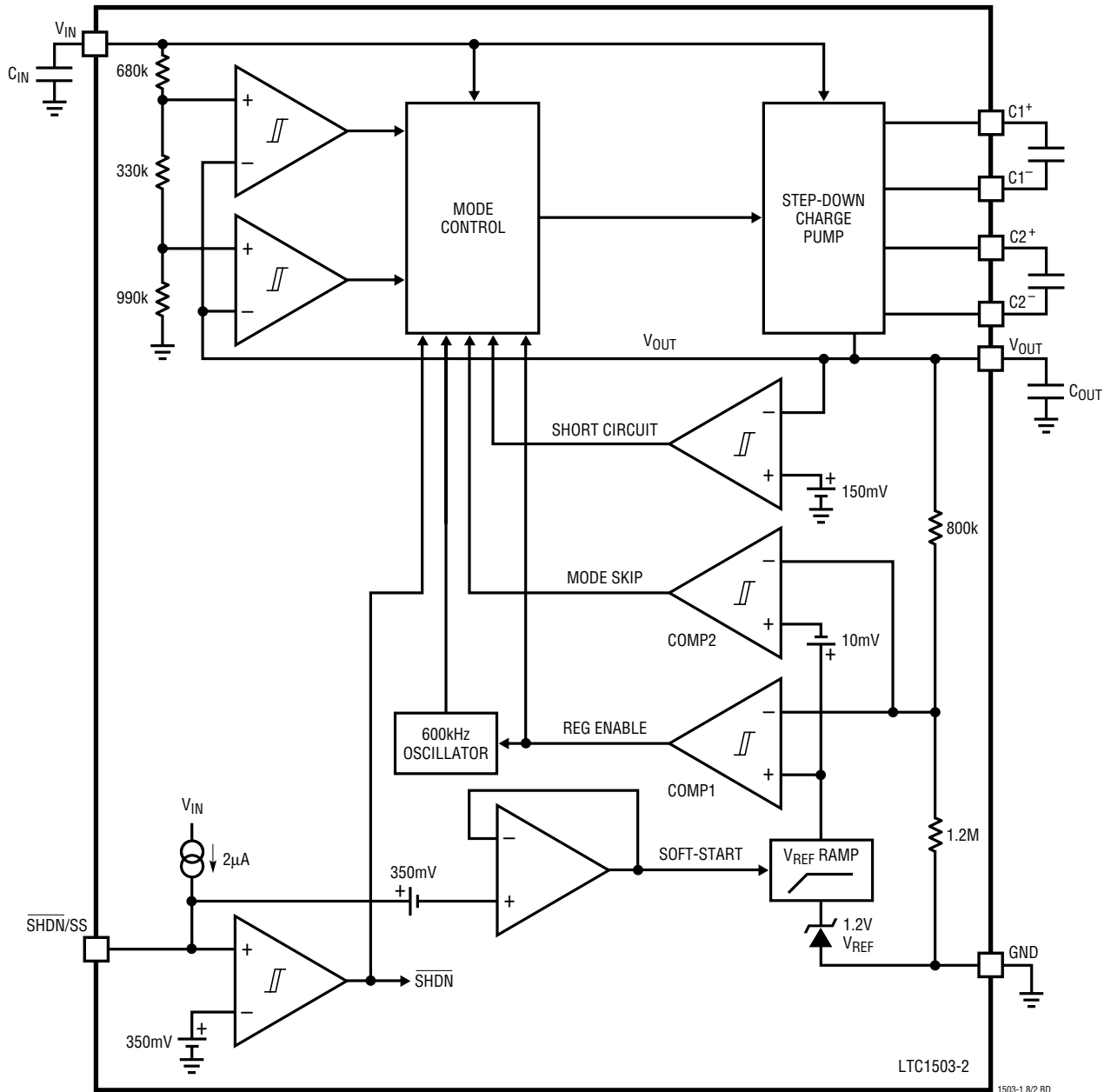

## APPLICATIONS INFORMATION

### General Operation

The two most common methods for providing regulated step-down DC/DC conversion are linear DC/DC conversion (used by LDOs) and inductor-based DC/DC conversion. Linear regulation provides low cost and low complexity, but the conversion efficiency is poor since all of the load current must come directly from  $V_{IN}$ . Inductor-based step-down conversion provides the highest efficiency, but the solution cost and circuit complexity are much higher. The LTC1503-X provides the efficiency advantages associated with inductor-based circuits as well as the cost and simplicity advantages of an inductorless converter.

The LTC1503-X is a switched capacitor step-down DC/DC converter. The part uses an internal switch network and fractional conversion ratios to achieve high efficiency over widely varying  $V_{IN}$  and output load conditions. Internal control circuitry selects the appropriate step-down conversion ratio based on  $V_{IN}$ ,  $V_{OUT}$  and load conditions to optimize efficiency. The part has three possible step-down modes: 2-to-1, 3-to-2 or 1-to-1 (gated switch) step-down mode. Only two external flying caps are needed to operate in all three modes. 2-to-1 mode is chosen when  $V_{IN}$  is greater than two times the desired  $V_{OUT}$ . 3-to-2 mode is chosen when  $V_{IN}$  is greater than 1.5 times  $V_{OUT}$  but less than 2 times  $V_{OUT}$ . 1-to-1 mode is chosen when  $V_{IN}$  falls below 1.5 times  $V_{OUT}$ . An internal mode skip function will switch the step-down ratio as needed to maintain output regulation under heavy load conditions.

Regulation is achieved by sensing the divided down output voltage and enabling the charge pump as needed to boost the output back into regulation. This method of regulation allows the LTC1503-X to achieve high efficiency at very light loads. The part has shutdown capability as well as user controlled inrush current limiting. In addition, the part can withstand an indefinite short-circuit condition on  $V_{OUT}$  and is also overtemperature protected.

### Step-Down Charge Pump Operation

Figure 1a shows the charge pump switch configuration that is used for 2-to-1 step down. When the charge pump is enabled in this mode, a two phase nonoverlapping clock generates the switch control signals. On phase one of the clock, flying capacitor C1 is connected through switches

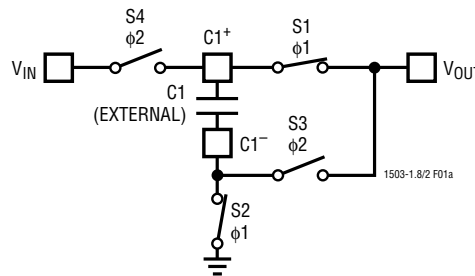

Figure 1a. Step-Down Charge Pump in 2-to-1 Mode

S1 and S2 across  $V_{OUT}$ . If the voltage on C1 is greater than the voltage on  $C_{OUT}$ , charge is transferred from C1 onto  $C_{OUT}$ . On phase two, the top plate of C1 is connected to  $V_{IN}$  and the bottom plate is connected to  $V_{OUT}$ . If the voltage across C1 is less than  $V_{IN}/2$  during phase two, charge will be transferred from C1 onto  $C_{OUT}$  thereby boosting the voltage on  $C_{OUT}$  and raising the voltage across C1. Thus, in 2-to-1 mode, charge transfer from C1 onto  $C_{OUT}$  occurs on both phases of the clock, and the voltage on  $C_{OUT}$  is driven towards  $1/2V_{IN}$  until the output is back in regulation. Since charge current is sourced from ground on phase one of the clock, current multiplication is realized with respect to  $V_{IN}$ , i.e.,  $I_{V_{OUT}}$  equals approximately  $2 \cdot I_{V_{IN}}$ . This results in significant efficiency improvement relative to a linear regulator.

The 3-to-2 conversion mode also uses a nonoverlapping clock for switch control but requires two flying capacitors and a total of seven switches (see Figure 1b). On phase one, C1 and C2 are connected in series across  $V_{OUT}$ . If the sum of the voltages across C1 and C2 is greater than  $V_{OUT}$ , charge is transferred from the flying caps onto  $C_{OUT}$  thereby reducing the average voltage on the flying caps and raising the voltage on the output capacitor. On phase two, the two flying capacitors are connected on parallel between  $V_{IN}$  and  $V_{OUT}$ . Since the average voltage across the two capacitors during phase one is  $V_{OUT}/2$ , charge will be transferred from  $V_{IN}$  to  $V_{OUT}$  through the two flying caps if  $V_{IN}$  minus  $V_{OUT}/2$  is greater than  $V_{OUT}$ . In this manner, charge is again transferred from the flying caps to the output on both phases of the clock, and the voltage on  $C_{OUT}$  is driven towards  $(2/3)V_{IN}$  until the part is back in regulation. As in 2-to-1 mode, charge current is sourced from ground on phase one of the clock which results in increased power efficiency.  $I_{V_{OUT}}$  in 3-to-2 mode equals approximately  $(3/2)I_{V_{IN}}$ .

## APPLICATIONS INFORMATION

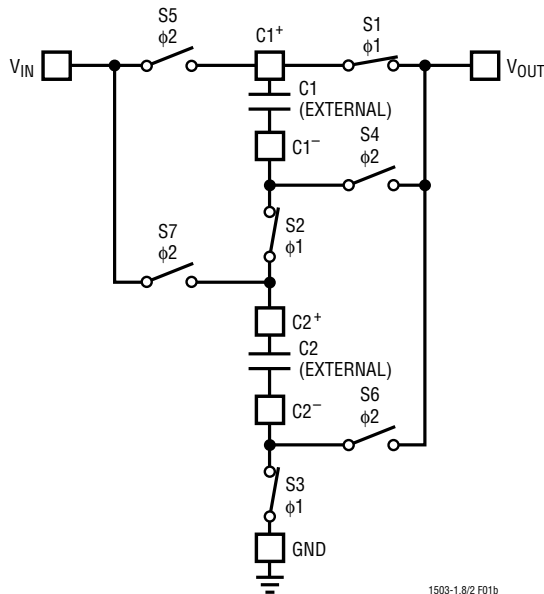

Figure 1b. Step-Down Charge Pump in 3-to-2 Mode

In 1-to-1 mode, switch S1 and S2 are connected in series between  $V_{IN}$  and  $V_{OUT}$  as needed to boost  $V_{OUT}$  back into regulation (see Figure 1c). The REG ENABLE signal from the main comparator (COMP1) controls switches S1 and S2 directly. Since all of the  $V_{OUT}$  current is sourced from  $V_{IN}$ , the efficiency in 1-to-1 mode is approximately equal to that of a linear regulator.

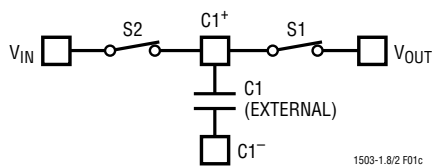

Figure 1c. Step-Down Charge Pump in 1-to-1 Mode

### Mode Selection and Mode Skipping

The optimal step-down conversion mode is chosen based on  $V_{IN}$  to  $V_{OUT}$  differential voltage and output load conditions. Two internal comparators are used to select the default step-down mode based on the  $V_{IN}$  and  $V_{OUT}$  voltage. A separate comparator (COMP2) is used to sense a droop on  $V_{OUT}$  due to a heavy output load and force the charge pump to skip to a higher output current mode to

maintain regulation. This will only occur as  $V_{IN}/V_{OUT}$  nears a 3-to-2 or 1-to-1 transition point. For example, under light load conditions, the LTC1503-X can operate in 2-to-1 mode when  $V_{IN}$  equals 4.1V with greater than 90% efficiency. However, when the load is increased, the part can no longer supply enough output current in 2-to-1 mode to maintain regulation. This causes  $V_{OUT}$  to droop below the regulation point until COMP2 trips and forces the part to skip from 2-to-1 mode to 3-to-2 mode. The COMP2 threshold is about 17mV ( $V_{OUT}$  referred) below the main comparator regulation point. Hysteresis in COMP2 will force the part to transition in and out of mode skipping. This will result in a slight  $V_{OUT}$  decrease of approximately 20mV under mode skipping conditions.

### Shutdown/Soft-Start Operation

The  $\overline{\text{SHDN/SS}}$  pin is used to implement both low current shutdown and soft-start. The soft-start feature limits inrush currents when the regulator is initially powered up or taken out of shutdown. Forcing a voltage lower than 0.35V (typ) will put the part into shutdown mode. Shutdown mode disables all control circuitry and forces the charge pump  $V_{OUT}$  into a high impedance state. A 2 $\mu$ A pull-up current on the  $\overline{\text{SHDN/SS}}$  pin will force the part into active mode if the pin is left floating or is driven with an open-drain output that is in a high impedance state. If the pin is not driven with an open-drain device, it must be forced to a logic high voltage of 2.2V (min) to ensure proper  $V_{OUT}$  regulation. The  $\overline{\text{SHDN/SS}}$  pin should not be driven to a voltage higher than  $V_{IN}$ .

To implement soft-start, the  $\overline{\text{SHDN/SS}}$  pin must be driven with an open-drain device and a capacitor must be connected from the  $\overline{\text{SHDN/SS}}$  pin to GND. Once the open-drain device is turned off, a 2 $\mu$ A pull-up current will begin charging the external SS capacitor and force the voltage on the pin to ramp towards  $V_{IN}$ . As soon as the  $\overline{\text{SHDN}}$  threshold is reached (0.35V typ), the internal reference voltage which controls the  $V_{OUT}$  regulation point will follow the ramp voltage on the  $\overline{\text{SHDN/SS}}$  pin (minus a 0.35V offset to account for the  $\overline{\text{SHDN}}$  threshold) until the reference reaches its final band gap voltage. This occurs when the voltage on the  $\overline{\text{SHDN/SS}}$  pin reaches

## APPLICATIONS INFORMATION

approximately 1.9V. Since the ramp rate on the  $\overline{\text{SHDN/SS}}$  pin controls the ramp rate on  $V_{\text{OUT}}$ , the average inrush current can be controlled through selection of  $C_{\text{SS}}$  and  $C_{\text{OUT}}$ . For example, a 4.7nF capacitor on  $\overline{\text{SHDN/SS}}$  results in a 4ms ramp time from 0.35V to 1.9V on the pin. If  $C_{\text{OUT}}$  is 10 $\mu\text{F}$ , the 4ms  $V_{\text{REF}}$  ramp time results in an average  $C_{\text{OUT}}$  charge current of only 5mA (see Figure 2c).

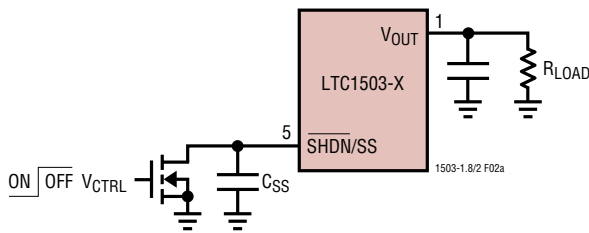

(a)

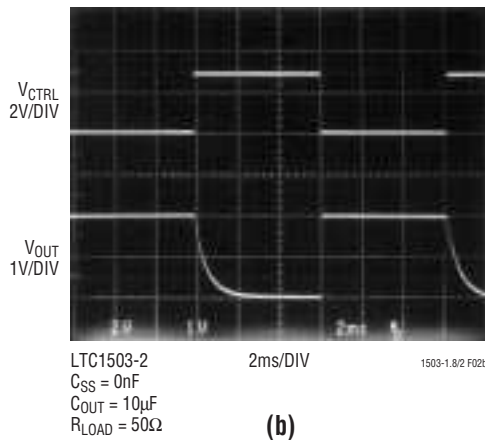

(b)

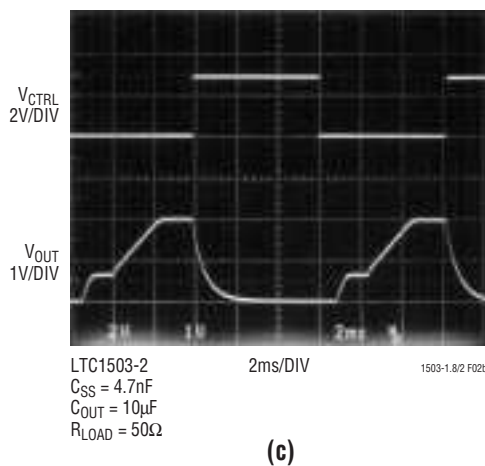

(c)

Figure 2. Shutdown/Soft-Start Operation

### Capacitor Selection

For best performance, it is recommended that low ESR capacitors be used for  $C_{\text{IN}}$  and  $C_{\text{OUT}}$  to reduce noise and ripple. If the ESR of the output capacitor is too high ( $>0.5\Omega$ ), both efficiency and output load regulation may be degraded. The  $C_{\text{IN}}$  and  $C_{\text{OUT}}$  capacitors should be either ceramic or tantalum and should be 10 $\mu\text{F}$  or greater. If the input source impedance is very low ( $<0.5\Omega$ ),  $C_{\text{IN}}$  may not be needed. Ceramic capacitors are recommended for the flying caps C1 and C2 with values of 0.47 $\mu\text{F}$  to 2.2 $\mu\text{F}$ . Smaller values may be used in low output current applications (e.g.,  $I_{\text{OUT}} < 10\text{mA}$ ). For best performance choose the same capacitance value for both C1 and C2.

### Output Ripple

Normal LTC1503-X operation produces voltage ripple on the  $V_{\text{OUT}}$  pin. Output voltage ripple is required for the parts to regulate. Low frequency ripple exists due to the hysteresis in the sense comparator and propagation delays in the charge pump enable/disable circuits. High frequency ripple is also present mainly from the ESR (equivalent series resistance) in the output capacitor. Typical output ripple ( $V_{\text{IN}} = 3.6\text{V}$ ) under maximum load is 25mV peak-to-peak with a low ESR 10 $\mu\text{F}$  output capacitor.

The magnitude of ripple voltage depends on several factors. High input voltages increase the output ripple since more charge is delivered to  $C_{\text{OUT}}$  per charging cycle. Large output current load and/or a small output capacitor ( $<10\mu\text{F}$ ) results in higher ripple due to higher output voltage  $dV/dt$ . High ESR capacitors ( $\text{ESR} > 0.5\Omega$ ) on the output pin cause high frequency voltage spikes on  $V_{\text{OUT}}$  with every clock cycle.

There are several ways to reduce the output voltage ripple (see Figure 3). A larger  $C_{\text{OUT}}$  capacitor (22 $\mu\text{F}$  or greater) will reduce both the low and high frequency ripple due to the lower  $C_{\text{OUT}}$  charging and discharging  $dV/dt$  and the lower ESR typically found with higher value (larger case size) capacitors. A low ESR ceramic output capacitor will minimize the high frequency ripple, but will not reduce the low frequency ripple unless a high capacitance value is chosen. A reasonable compromise is to use a 10 $\mu\text{F}$  to 22 $\mu\text{F}$  tantalum capacitor in parallel with a 1 $\mu\text{F}$  to 3.3 $\mu\text{F}$  ceramic

## APPLICATIONS INFORMATION

capacitor on  $V_{OUT}$  to reduce both the low and high frequency ripple. An RC filter may also be used to reduce high frequency voltage spikes.

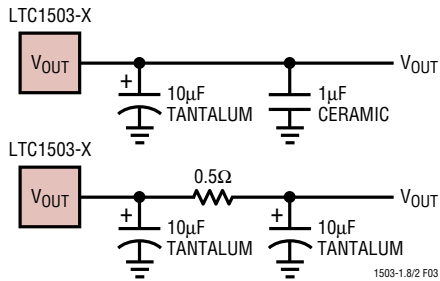

Figure 3. Output Ripple Reduction Techniques

### Protection Features

The LTC1503-X contains both thermal shutdown and short-circuit protection features. The charge pump will shut down when the junction temperature reaches approximately 150°C and will resume operation once the junction temperature has dropped back to 125°C. The part will limit output current to 20mA (typ) when a short-circuit condition ( $V_{OUT} < 150\text{mV}$ ) exists to prevent damage to the internal switches. During start-up, the 20mA current limit

is disabled once  $V_{OUT}$  reaches 0.7V (typ). The part can survive an indefinite short from  $V_{OUT}$  to GND.

### Layout Considerations

For best regulation and noise performance, careful board layout is required. Improper bypassing and grounding may lead to poor load regulation and output ripple performance. All capacitors, especially  $C_{IN}$  and  $C_{OUT}$ , must be as close as possible to the  $V_{IN}$  and  $V_{OUT}$  pins. Connecting the GND pin and all bypass capacitors to an uninterrupted ground plane is also advised. See Figure 4 for recommended component placement and grounding.

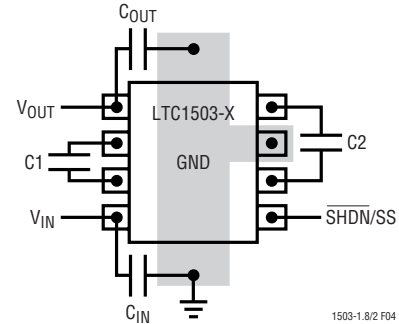
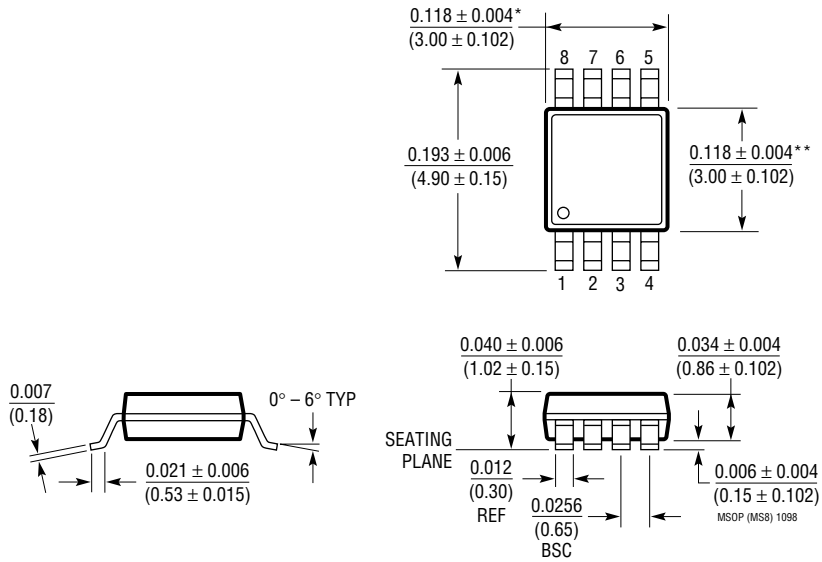

Figure 4. Recommended Component Placement and Grounding

**PACKAGE DESCRIPTION** Dimensions in inches (millimeters) unless otherwise noted.

**MS8 Package**  
**8-Lead Plastic MSOP**  
 (LTC DWG # 05-08-1660)



\* DIMENSION DOES NOT INCLUDE MOLD FLASH, PROTRUSIONS OR GATE BURRS. MOLD FLASH, PROTRUSIONS OR GATE BURRS SHALL NOT EXCEED 0.006" (0.152mm) PER SIDE

\*\* DIMENSION DOES NOT INCLUDE INTERLEAD FLASH OR PROTRUSIONS. INTERLEAD FLASH OR PROTRUSIONS SHALL NOT EXCEED 0.006" (0.152mm) PER SIDE

**PACKAGE DESCRIPTION** Dimensions in inches (millimeters) unless otherwise noted.

**S8 Package**  
**8-Lead Plastic Small Outline (Narrow 0.150)**  
 (LTC DWG # 05-08-1610)

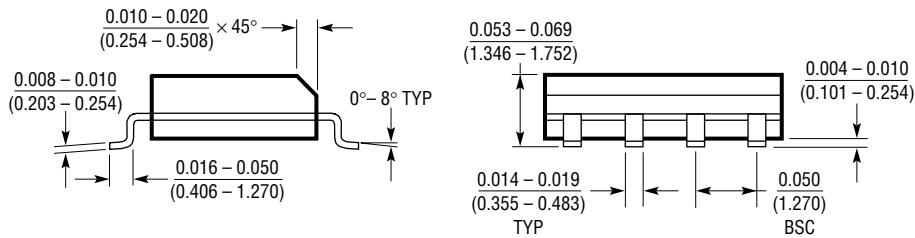
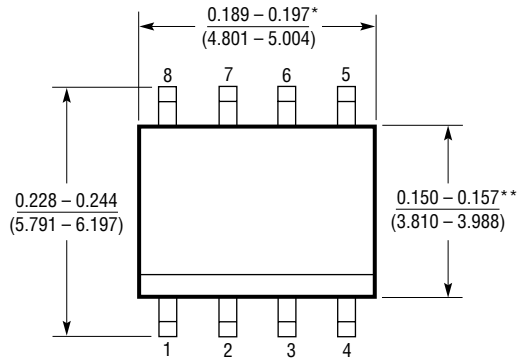

\*DIMENSION DOES NOT INCLUDE MOLD FLASH. MOLD FLASH SHALL NOT EXCEED 0.006" (0.152mm) PER SIDE  
 \*\*DIMENSION DOES NOT INCLUDE INTERLEAD FLASH. INTERLEAD FLASH SHALL NOT EXCEED 0.010" (0.254mm) PER SIDE

SO8 1298

## TYPICAL APPLICATION

DC/DC Converter with Shutdown and Soft-Start

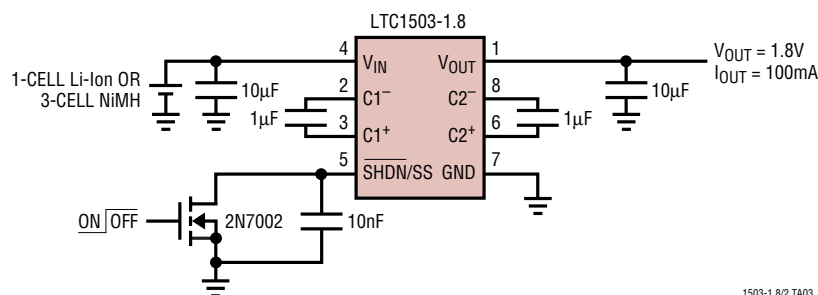

1503-1.8/2 TA03

## RELATED PARTS

PART NUMBER	DESCRIPTION	COMMENTS
LTC1474/LTC1475	Low Quiescent Current Step-Down DC/DC Converter	$I_{OUT}$ to 250mA, $I_Q = 10\mu A$ ; 8-Lead MSOP
LTC1502-3.3	Single Cell to 3.3V Quadrupler Charge Pump	$V_{IN} = 0.9V$ to 1.8V, $I_{OUT} = 10mA$ ; $I_Q = 40\mu A$
LTC1514/LTC1515	Micropower, Regulated 5V Step-Up/Step-Down Charge Pump DC/DC Converters	2V to 10V Input Range; Up to 50mA Output Current; Short-Circuit and Overtemperature Protected
LTC1555/LTC1556	SIM Power Supply and Level Translator	Step-Up/Step-Down Charge Pump Generates 5V or 3V
LTC1627	Monolithic Synchronous Buck Step-Down Switching Regulator	2.65V to 8.5V Input Range; $V_{OUT}$ from 0.8V, $I_{OUT}$ to 500mA; Low Dropout Operation; 100% Duty Cycle
LTC1754-3.3	3.3V Charge Pump with Shutdown in SOT-23	50mA Output Current, $I_{CC} = 13\mu A$
LTC1754-5	5V Charge Pump with Shutdown in SOT-23	50mA Output Current, $I_{CC} = 13\mu A$