

High Efficiency USB Power Manager with Boost, Buck-Boost and Dual Bucks

DESCRIPTION

The LTC[®]3586/LTC3586-1 are highly integrated power management and battery charger ICs for Li-Ion/Polymer battery applications. They include a high efficiency current limited switching PowerPath manager with automatic load prioritization, battery charger, ideal diode, and four synchronous switching regulators (two bucks, one buck-boost and one boost). Designed specifically for USB applications, the LTC3586/LTC3586-1's switching power manager automatically limits input current to a maximum of either 100mA or 500mA for USB applications or 1A for adapter-powered applications.

Unlike linear chargers, the LTC3586/LTC3586-1 switching architecture transmits nearly all of the power available from the USB port to the load with minimal loss and heat which eases thermal constraints in small places. The two buck regulators can provide up to 400mA each, the buck-boost can deliver 1A, and the boost delivers at least 800mA.

The LTC3586/LTC3586-1 are available in a low profile (0.75mm) 38-pin 4mm × 6mm QFN package.

LT, LT, LTC and LTM are registered trademarks of Linear Technology Corporation. PowerPath and Bat-Track are trademarks of Linear Technology Corporation. All other trademarks are the property of their respective owners. Protected by U.S. Patents including 6522118, 6404251.

FEATURES

Power Manager

- High Efficiency Switching PowerPath™ Controller with Bat-Track™ Adaptive Output Control and “Instant-On” Operation
- Programmable USB or Wall Current Limit (100mA/500mA/1A)
- Full Featured Li-Ion/Polymer Battery Charger with Float Voltage of 4.1V (LTC3586-1) or 4.2V (LTC3586) with 1.5A Maximum Charge Current
- Internal 180mΩ Ideal Diode Plus External Ideal Diode Controller Powers Load in Battery Mode
- <30µA No-Load Quiescent Current when Powered from BAT
- Dual High Efficiency Buck DC/DCs (400mA I_{OUT})
- High Efficiency Buck-Boost DC/DC (1A I_{OUT})
- High Efficiency Boost DC/DC (800mA I_{OUT})
- Compact (4mm × 6mm × 0.75mm) 38-Pin QFN Package

APPLICATIONS

- Digital Still Cameras
- HDD-Based MP3 Players, PDAs, GPS, PMPs
- Other USB-Based Handheld Products

TYPICAL APPLICATION

High Efficiency PowerPath Manager, Dual Buck, Buck-Boost and Boost

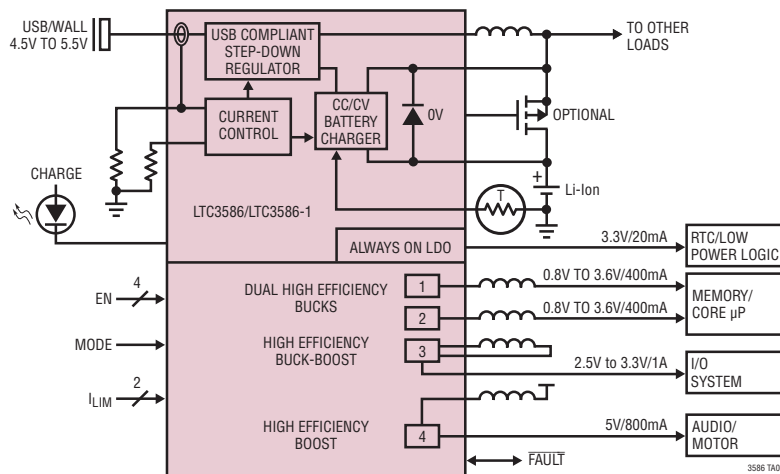

Battery Charge Current vs Battery Voltage (LTC3586)

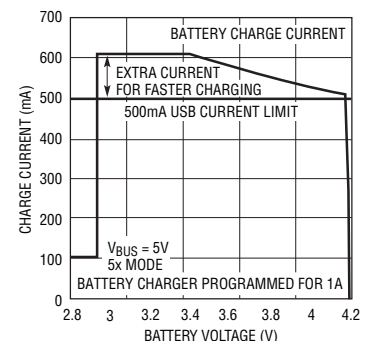

LTC3586/LTC3586-1

ABSOLUTE MAXIMUM RATINGS

(Notes 1, 5)

V_{BUS} (Transient) $t < 1\text{ms}$, Duty Cycle $< 1\%$	-0.3V to 7V
V_{IN1} , V_{IN2} , V_{IN3} , V_{IN4} , V_{BUS} (Static), BAT, NTC, $\overline{\text{CHRG}}$, $\overline{\text{FAULT}}$, I_{LIM0} , I_{LIM1} , EN3, EN4, MODE, FB4, V_{OUT4}	-0.3V to 6V
FB1	-0.3V to Lesser of 6V and ($V_{IN1} + 0.3\text{V}$)
FB2	-0.3V to Lesser of 6V and ($V_{IN2} + 0.3\text{V}$)
FB3, V_{C3}	-0.3V to Lesser of 6V and ($V_{IN3} + 0.3\text{V}$)
EN1, EN2	-0.3V to Lesser of 6V and Max (V_{BUS} , V_{OUT} , BAT) + 0.3V
I_{CLPROG}	3mA
$I_{\overline{\text{FAULT}}}$, $I_{\overline{\text{CHRG}}}$	50mA
I_{PROG}	2mA
I_{LDO3V3}	30mA
I_{SW1} , I_{SW2}	600mA
I_{SW} , I_{BAT} , I_{VOUT}	2A
I_{SWAB3} , I_{SWCD3} , I_{SW4} , I_{VOUT3}	2.5A
Operating Temperature Range (Note 2)....	-40°C to 85°C
Junction Temperature (Note 3)	125°C
Storage Temperature Range	-65°C to 125°C

PIN CONFIGURATION

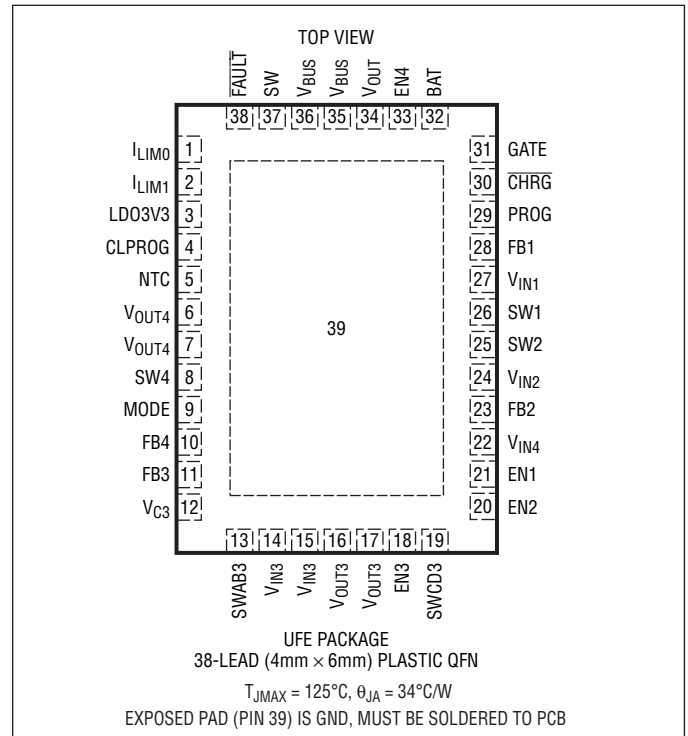

ORDER INFORMATION

LEAD FREE FINISH	TAPE AND REEL	PART MARKING	PACKAGE DESCRIPTION	TEMPERATURE RANGE
LTC3586EUF#PBF	LTC3586EUF#TRPBF	3586	38-Lead (4mm × 6mm) Plastic QFN	-40°C to 85°C
LTC3586EUF-1#PBF	LTC3586EUF-1#TRPBF	35861	38-Lead (4mm × 6mm) Plastic QFN	-40°C to 85°C

Consult LTC Marketing for parts specified with wider operating temperature ranges.

Consult LTC Marketing for information on non-standard lead based finish parts.

For more information on lead free part marking, go to: <http://www.linear.com/leadfree/>

For more information on tape and reel specifications, go to: <http://www.linear.com/tapeandree/>

ELECTRICAL CHARACTERISTICS The ● denotes the specifications which apply over the full operating temperature range, otherwise specifications are at $T_A = 25^{\circ}\text{C}$. $V_{BUS} = 5\text{V}$, BAT = 3.8V, $V_{IN1} = V_{IN2} = V_{IN3} = V_{IN4} = V_{OUT3} = 3.8\text{V}$, $V_{OUT4} = 5\text{V}$, $R_{PROG} = 1\text{k}$, $R_{CLPROG} = 3.01\text{k}$, unless otherwise noted.

SYMBOL	PARAMETER	CONDITIONS	MIN	TYP	MAX	UNITS	
PowerPath Switching Regulator							
V_{BUS}	Input Supply Voltage		4.35		5.5	V	
I_{BUSLIM}	Total Input Current	1x Mode, $V_{OUT} = \text{BAT}$ 5x Mode, $V_{OUT} = \text{BAT}$ 10x Mode, $V_{OUT} = \text{BAT}$ Suspend Mode, $V_{OUT} = \text{BAT}$	● ● ● ●	87 436 800 0.31	95 460 860 0.38	100 500 1000 0.50	mA mA mA mA
I_{VBUSQ}	V_{BUS} Quiescent Current	1x Mode, $I_{VOUT} = 0\text{mA}$ 5x Mode, $I_{VOUT} = 0\text{mA}$ 10x Mode, $I_{VOUT} = 0\text{mA}$ Suspend Mode, $I_{VOUT} = 0\text{mA}$			7 15 15 0.044		mA mA mA mA

3586fb

ELECTRICAL CHARACTERISTICS The ● denotes the specifications which apply over the full operating temperature range, otherwise specifications are at $T_A = 25^\circ\text{C}$. $V_{\text{BUS}} = 5\text{V}$, $\text{BAT} = 3.8\text{V}$, $V_{\text{IN1}} = V_{\text{IN2}} = V_{\text{IN3}} = V_{\text{IN4}} = V_{\text{OUT3}} = 3.8\text{V}$, $V_{\text{OUT4}} = 5\text{V}$, $R_{\text{PROG}} = 1\text{k}$, $R_{\text{CLPROG}} = 3.01\text{k}$, unless otherwise noted.

SYMBOL	PARAMETER	CONDITIONS	MIN	TYP	MAX	UNITS
h_{CLPROG} (Note 4)	Ratio of Measured V_{BUS} Current to CLPROG Program Current	1x Mode 5x Mode 10x Mode Suspend Mode		224 1133 2140 9.3		mA/mA mA/mA mA/mA mA/mA
$I_{\text{OUT(POWERPATH)}}$	V_{OUT} Current Available Before Loading BAT	1x Mode, $\text{BAT} = 3.3\text{V}$ 5x Mode, $\text{BAT} = 3.3\text{V}$ 10x Mode, $\text{BAT} = 3.3\text{V}$ Suspend Mode		135 672 1251 0.32		mA mA mA mA
V_{CLPROG}	CLPROG Servo Voltage in Current Limit	1x, 5x, 10x Modes Suspend Mode		1.188 100		V mV
$V_{\text{UVLO_VBUS}}$	V_{BUS} Undervoltage Lockout	Rising Threshold Falling Threshold	3.95	4.30 4.00	4.35	V V
$V_{\text{UVLO_VBUS-BAT}}$	V_{BUS} to BAT Differential Undervoltage Lockout	Rising Threshold Falling Threshold		200 50		mV mV
V_{OUT}	V_{OUT} Voltage	1x, 5x, 10x Modes, $0\text{V} < \text{BAT} < 4.2\text{V}$, $I_{\text{VOUT}} = 0\text{mA}$, Battery Charger Off USB Suspend Mode, $I_{\text{VOUT}} = 250\mu\text{A}$	3.5 4.5	BAT + 0.3 4.6	4.7 4.7	V V
f_{OSC}	Switching Frequency		1.8	2.25	2.7	MHz
$R_{\text{PMOS_POWERPATH}}$	PMOS On-Resistance			0.18		Ω
$R_{\text{NMOS_POWERPATH}}$	NMOS On-Resistance			0.30		Ω
$I_{\text{PEAK_POWERPATH}}$	Peak Switch Current Limit (Note 5)	1x, 5x Modes 10x Mode		2 3		A A

Battery Charger

V_{FLOAT}	BAT Regulated Output Voltage	LTC3586 LTC3586 LTC3586-1 LTC3586-1		4.179 4.165 4.079 4.065	4.200 4.200 4.100 4.100	4.221 4.235 4.121 4.135	V V V V
I_{CHG}	Constant Current Mode Charge Current	$R_{\text{PROG}} = 1\text{k}$ $R_{\text{PROG}} = 5\text{k}$		980 185	1022 204	1065 223	mA mA
I_{BAT}	Battery Drain Current	$V_{\text{BUS}} > V_{\text{UVLO}}$, $I_{\text{VOUT}} = 0\mu\text{A}$ $V_{\text{BUS}} = 0\text{V}$, $I_{\text{VOUT}} = 0\mu\text{A}$ (Ideal Diode Mode)		2	3.5 29	5 41	μA μA
V_{PROG}	PROG Pin Servo Voltage			1.000			V
$V_{\text{PROG_TRKL}}$	PROG Pin Servo Voltage in Trickle Charge	$\text{BAT} < V_{\text{TRKL}}$		0.100			V
$V_{\text{C/10}}$	C/10 Threshold Voltage at PROG			100			mV
h_{PROG}	Ratio of I_{BAT} to PROG Pin Current			1022			mA/mA
I_{TRKL}	Trickle Charge Current	$\text{BAT} < V_{\text{TRKL}}$		100			mA
V_{TRKL}	Trickle Charge Threshold Voltage	BAT Rising	2.7	2.85	3.0		V
ΔV_{TRKL}	Trickle Charge Hysteresis Voltage			130			mV
V_{RECHRG}	Recharge Battery Threshold Voltage	Threshold Voltage Relative to V_{FLOAT}	-75	-100	-125		mV
t_{TERM}	Safety Timer Termination	Timer Starts When $\text{BAT} = V_{\text{FLOAT}}$	3.3	4	5		Hour
t_{BADBAT}	Bad Battery Termination Time	$\text{BAT} < V_{\text{TRKL}}$	0.42	0.5	0.63		Hour
$h_{\text{C/10}}$	End-of-Charge Indication Current Ratio	(Note 6)	0.088	0.1	0.112		mA/mA
V_{CHRG}	CHRG Pin Output Low Voltage	$I_{\text{CHRG}} = 5\text{mA}$		65	100		mV
I_{CHRG}	CHRG Pin Leakage Current	$V_{\text{CHRG}} = 5\text{V}$			1		μA

LTC3586/LTC3586-1

ELECTRICAL CHARACTERISTICS The ● denotes the specifications which apply over the full operating temperature range, otherwise specifications are at $T_A = 25^\circ\text{C}$. $V_{\text{BUS}} = 5\text{V}$, $\text{BAT} = 3.8\text{V}$, $V_{\text{IN}1} = V_{\text{IN}2} = V_{\text{IN}3} = V_{\text{IN}4} = V_{\text{OUT}3} = 3.8\text{V}$, $V_{\text{OUT}4} = 5\text{V}$, $R_{\text{PROG}} = 1\text{k}$, $R_{\text{CLPROG}} = 3.01\text{k}$, unless otherwise noted.

SYMBOL	PARAMETER	CONDITIONS	MIN	TYP	MAX	UNITS
$R_{\text{ON_CHG}}$	Battery Charger Power FET On-Resistance (Between V_{OUT} and BAT)			0.18		Ω
T_{LIM}	Junction Temperature in Constant Temperature Mode			110		$^\circ\text{C}$
NTC						
V_{COLD}	Cold Temperature Fault Threshold Voltage	Rising Threshold Hysteresis	75.0	76.5 1.5	78.0	$\%V_{\text{BUS}}$ $\%V_{\text{BUS}}$
V_{HOT}	Hot Temperature Fault Threshold Voltage	Falling Threshold Hysteresis	33.4	34.9 1.73	36.4	$\%V_{\text{BUS}}$ $\%V_{\text{BUS}}$
V_{DIS}	NTC Disable Threshold Voltage	Falling Threshold Hysteresis	0.7	1.7 50	2.7	$\%V_{\text{BUS}}$ mV
I_{NTC}	NTC Leakage Current	$V_{\text{NTC}} = V_{\text{BUS}} = 5\text{V}$	-50		50	nA
Ideal Diode						
V_{FWD}	Forward Voltage	$V_{\text{BUS}} = 0\text{V}$, $I_{\text{VOUT}} = 10\text{mA}$ $I_{\text{VOUT}} = 10\text{mA}$		2 15		mV mV
R_{DROPOUT}	Internal Diode On-Resistance, Dropout	$V_{\text{BUS}} = 0\text{V}$		0.18		Ω
$I_{\text{MAX_DIODE}}$	Internal Diode Current Limit		1.6			A
Always On 3.3V Supply						
V_{LD03V3}	Regulated Output Voltage	$0\text{mA} < I_{\text{LD03V3}} < 20\text{mA}$	3.1	3.3	3.5	V
$R_{\text{CL_LD03V3}}$	Closed-Loop Output Resistance			4		Ω
$R_{\text{OL_LD03V3}}$	Dropout Output Resistance			23		Ω
Logic Input (EN1, EN2, EN3, EN4, MODE, ILIMO, ILIM1, FAULT)						
V_{IL}	Logic Low Input Voltage				0.4	V
V_{IH}	Logic High Input Voltage		1.2			V
I_{PD}	Pull-Down Current			1		μA
FAULT Output						
V_{FAULT}	FAULT Pin Output Low Voltage	$I_{\text{FAULT}} = 5\text{mA}$		65	100	mV
	FAULT Delay			14		ms
	FBx Voltage Threshold for FAULT (x = 1, 2, 3, 4)			0.736		V
Switching Regulators 1, 2, 3 and 4						
$V_{\text{IN}1,2,3,4}$	Input Supply Voltage		2.7		5.5	V
V_{OUTUVLO}	$V_{\text{OUT UVLO}} - V_{\text{OUT}}$ Falling $V_{\text{OUT UVLO}} - V_{\text{OUT}}$ Rising	$V_{\text{IN}1,2,3,4}$ Connected to V_{OUT} Through Low Impedance. Switching Regulators are Disabled in UVLO	2.5	2.6 2.8	2.9	V V
f_{OSC}	Oscillator Frequency		1.8	2.25	2.7	MHz
$I_{\text{FB}1,2,3,4}$	FBx Input Current	$V_{\text{FB}1,2,3,4} = 0.85\text{V}$	-50		50	nA
$V_{\text{FB}1,2,3,4}$	V_{FBx} Servo Voltage		● 0.78	0.80	0.82	V

ELECTRICAL CHARACTERISTICS The ● denotes the specifications which apply over the full operating temperature range, otherwise specifications are at $T_A = 25^\circ\text{C}$. $V_{\text{BUS}} = 5\text{V}$, $\text{BAT} = 3.8\text{V}$, $V_{\text{IN1}} = V_{\text{IN2}} = V_{\text{IN3}} = V_{\text{IN4}} = V_{\text{OUT3}} = 3.8\text{V}$, $V_{\text{OUT4}} = 5\text{V}$, $R_{\text{PROG}} = 1\text{k}$, $R_{\text{CLPROG}} = 3.01\text{k}$, unless otherwise noted.

SYMBOL	PARAMETER	CONDITIONS	MIN	TYP	MAX	UNITS	
Switching Regulators 1 and 2 (Buck)							
$I_{\text{VIN1,2}}$	Pulse-Skip Mode Input Current	$I_{\text{VOUT1,2}} = 0\mu\text{A}$, (Note 7)		225		μA	
	Burst Mode® Input Current	$I_{\text{VOUT1,2}} = 0\mu\text{A}$, (Note 7)		35	60	μA	
	Shutdown Input Current	$I_{\text{VOUT1,2}} = 0\mu\text{A}$, (Note 7)			1	μA	
$I_{\text{LIM1,2}}$	PMOS Switch Current Limit	Pulse-Skip/Burst Mode Operation (Note 5)	600	800	1100	mA	
$R_{\text{P1,2}}$	PMOS $R_{\text{DS(ON)}}$			0.6		Ω	
$R_{\text{N1,2}}$	NMOS $R_{\text{DS(ON)}}$			0.7		Ω	
$D_{1,2}$	Maximum Duty Cycle		100			%	
$R_{\text{SW1,2}}$	SW1,2 Pull-Down in Shutdown			10		$\text{k}\Omega$	
Switching Regulator 3 (Buck-Boost)							
I_{VIN3}	Input Current	PWM Mode, $I_{\text{VOUT3}} = 0\mu\text{A}$		220	400	μA	
		Burst Mode Operation, $I_{\text{VOUT3}} = 0\mu\text{A}$		13	20	μA	
		Shutdown		0	1	μA	
$V_{\text{OUT3(LOW)}}$	Minimum Regulated Output Voltage	For Burst Mode Operation or PWM Mode		2.65	2.75	V	
$V_{\text{OUT3(HIGH)}}$	Maximum Regulated Output Voltage		5.5	5.6		V	
I_{LIMF3}	Forward Current Limit (Switch A)	PWM Mode (Note 5)	●	2	2.5	3	A
$I_{\text{PEAK3(BURST)}}$	Forward Burst Current Limit (Switch A)	Burst Mode Operation	●	200	275	350	mA
$I_{\text{ZERO3(BURST)}}$	Reverse Burst Current Limit (Switch D)	Burst Mode Operation	●	-30	0	30	mA
$I_{\text{MAX3(BURST)}}$	Maximum Deliverable Output Current in Burst Mode Operation	$2.7\text{V} \leq V_{\text{IN3}} \leq 5.5\text{V}$, $2.75\text{V} \leq V_{\text{OUT3}} \leq 5.5\text{V}$ (Note 8)		50		mA	
$R_{\text{DS(ON)P}}$	PMOS $R_{\text{DS(ON)}}$	Switches A, D		0.22		Ω	
$R_{\text{DS(ON)N}}$	NMOS $R_{\text{DS(ON)}}$	Switches B, C		0.17		Ω	
$I_{\text{LEAK(P)}}$	PMOS Switch Leakage	Switches A, D		-1	1	μA	
$I_{\text{LEAK(N)}}$	NMOS Switch Leakage	Switches B, C		-1	1	μA	
R_{VOUT3}	V_{OUT3} Pull-Down in Shutdown			10		$\text{k}\Omega$	
$D_{\text{BUCK(MAX)}}$	Maximum Buck Duty Cycle	PWM Mode	●	100		%	
$D_{\text{BOOST(MAX)}}$	Maximum Boost Duty Cycle	PWM Mode		75		%	
t_{SS3}	Soft-Start Time			0.5		ms	
Switching Regulator 4 (Boost)							
I_{VIN4}	Input Current	$\text{FB4} > 0.8\text{V}$, $I_{\text{VOUT4}} = 0\mu\text{A}$ Shutdown, $V_{\text{OUT4}} = 0\text{V}$		180	1	μA μA	
I_{VOUT4}	Q-Current Drawn from Boost Output	$\text{FB4} = 0\text{V}$		7.5		mA	
I_{LIMF4}	NMOS Switch Current Limit	(Note 5)	2000	2800		mA	
V_{OUT4}	Output Voltage Adjust Range				5	V	
V_{OV4}	Overvoltage Shutdown		5.1	5.3	5.5	V	
ΔV_{OV4}	Overvoltage Shutdown Hysteresis			0.3		V	

Burst Mode is a registered trademark of Linear Technology Corporation.

LTC3586/LTC3586-1

ELECTRICAL CHARACTERISTICS The ● denotes the specifications which apply over the full operating temperature range, otherwise specifications are at $T_A = 25^\circ\text{C}$. $V_{\text{BUS}} = 5\text{V}$, $\text{BAT} = 3.8\text{V}$, $V_{\text{IN}1} = V_{\text{IN}2} = V_{\text{IN}3} = V_{\text{IN}4} = V_{\text{OUT}3} = 3.8\text{V}$, $V_{\text{OUT}4} = 5\text{V}$, $R_{\text{PROG}} = 1\text{k}$, $R_{\text{CLPROG}} = 3.01\text{k}$, unless otherwise noted.

SYMBOL	PARAMETER	CONDITIONS	MIN	TYP	MAX	UNITS
$R_{\text{DS(ON)P}4}$	PMOS $R_{\text{DS(ON)}}$	Synchronous Switch		0.25		Ω
$R_{\text{DS(ON)N}4}$	NMOS $R_{\text{DS(ON)}}$	Main Switch		0.17		Ω
$I_{\text{LEAK(P)4}}$	PMOS Switch Leakage	Synchronous Switch	-1		1	μA
$I_{\text{LEAK(N)4}}$	NMOS Switch Leakage	Main Switch	-1		1	μA
$R_{\text{VOUT}4}$	$V_{\text{OUT}4}$ Pull-Down in Shutdown			10		$\text{k}\Omega$
$D_{\text{BOOST(MAX)}}$	Maximum Boost Duty Cycle			91	94	%
$t_{\text{SS}4}$	Soft-Start Time			0.375		ms

Note 1: Stresses beyond those listed under Absolute Maximum Ratings may cause permanent damage to the device. Exposure to any Absolute Maximum Rating condition for extended periods may affect device reliability and lifetime.

Note 2: The LTC3586E/LTC3586E-1 are guaranteed to meet performance specifications from 0°C to 85°C . Specifications over the -40°C to 85°C operating temperature range are assured by design, characterization and correlation with statistical process controls.

Note 3: The LTC3586E/LTC3586E-1 include overtemperature protection that is intended to protect the device during momentary overload conditions. Junction temperature will exceed 125°C when overtemperature protection is active. Continuous operation above the specified maximum operating junction temperature may impair device reliability.

Note 4: Total input current is the sum of quiescent current, I_{VBUSQ} , and measured current given by:

$$V_{\text{CLPROG}}/R_{\text{CLPROG}} \cdot (h_{\text{CLPROG}} + 1)$$

Note 5: The current limit features of this part are intended to protect the IC from short term or intermittent fault conditions. Continuous operation above the maximum specified pin current rating may result in device degradation or failure.

Note 6: $h_{\text{C}/10}$ is expressed as a fraction of measured full charge current with indicated PROG resistor.

Note 7: FBx above regulation such that regulator is in sleep. Specification does not include resistive divider current reflected back to V_{INX} .

Note 8: Guaranteed by design.

TYPICAL PERFORMANCE CHARACTERISTIC ($T_A = 25^\circ\text{C}$ unless otherwise noted)

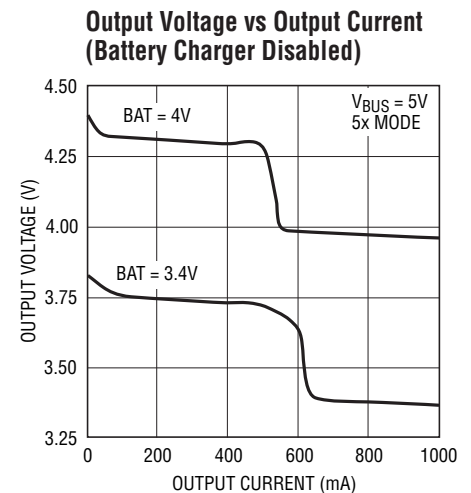
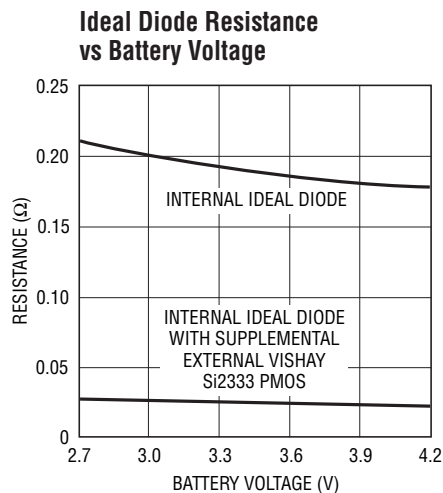
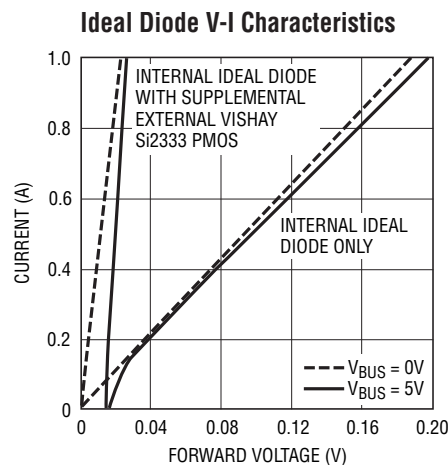

TYPICAL PERFORMANCE CHARACTERISTICS ($T_A = 25^\circ\text{C}$ unless otherwise noted)

USB Limited Battery Charge Current vs Battery Voltage

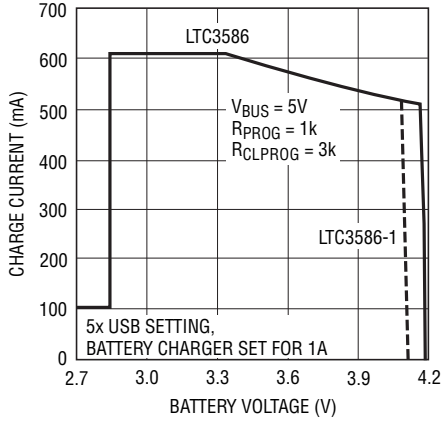

3586 G04

USB Limited Battery Charge Current vs Battery Voltage

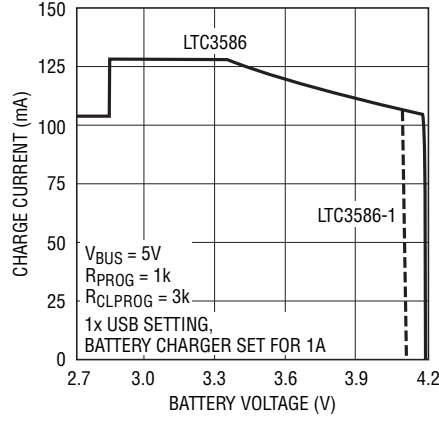

3586 G05

Battery Drain Current vs Battery Voltage

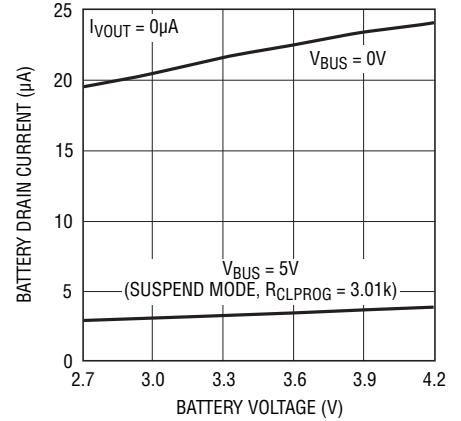

3586 G06

PowerPath Switching Regulator Efficiency vs Output Current

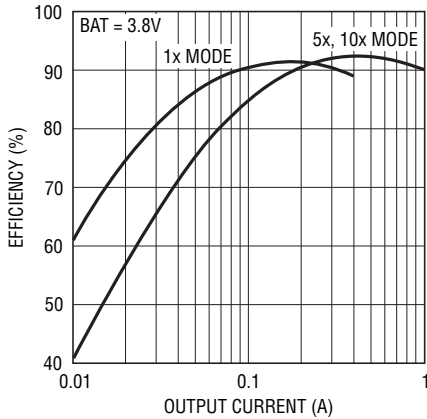

3586 G07

Battery Charging Efficiency vs Battery Voltage with No External Load (P_{BAT}/P_{BUS})

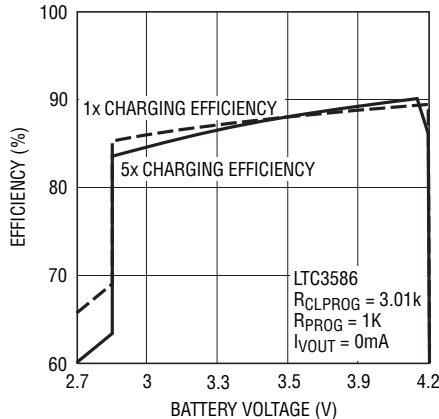

3586 G08

V_{BUS} Current vs V_{BUS} Voltage (Suspend)

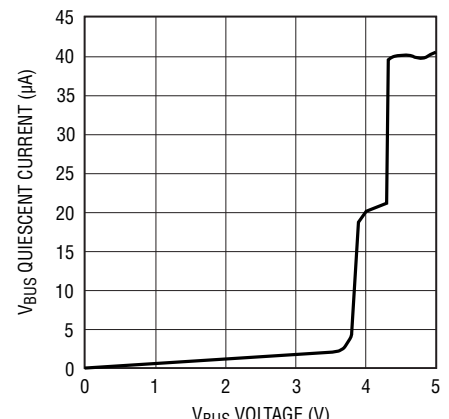

3586 G09

Output Voltage vs Output Current in Suspend

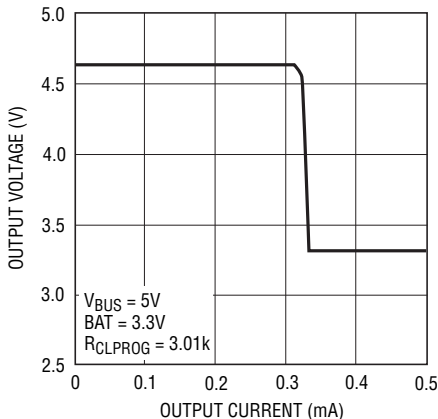

3586 G10

V_{BUS} Current vs Output Current in Suspend

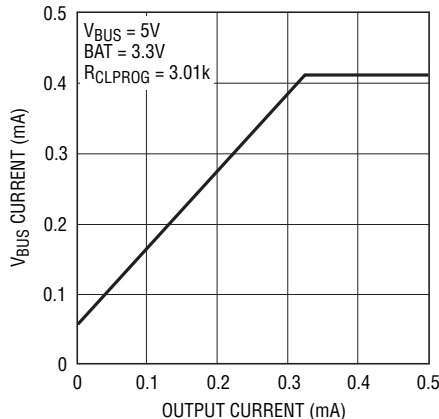

3586 G11

3.3V LDO Output Voltage vs Output Current, $V_{BUS} = 0V$

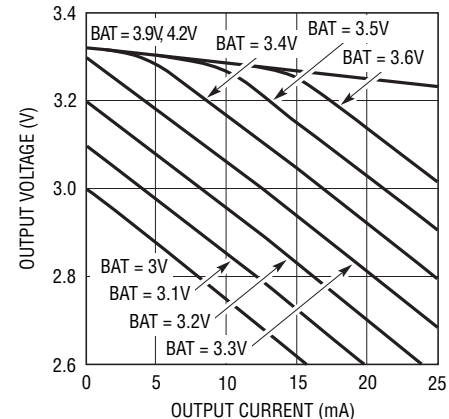

3586 G12

3586fb

TYPICAL PERFORMANCE CHARACTERISTICS (T_A = 25°C unless otherwise noted)

Battery Charge Current vs Temperature

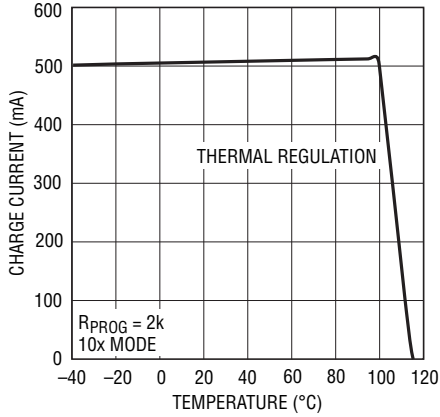

3586 G13

Battery Charger Float Voltage vs Temperature

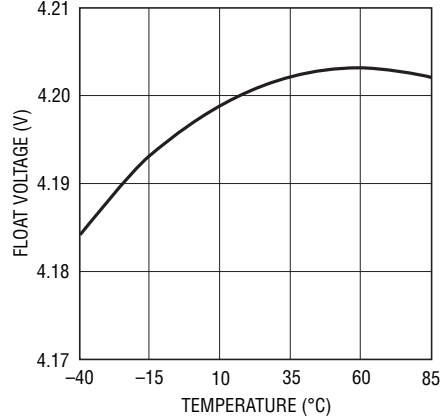

3586 G14

Low-Battery (Instant On) Output Voltage vs Temperature

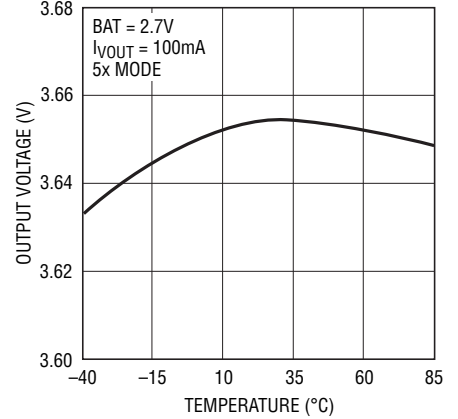

3586 G15

Oscillator Frequency vs Temperature

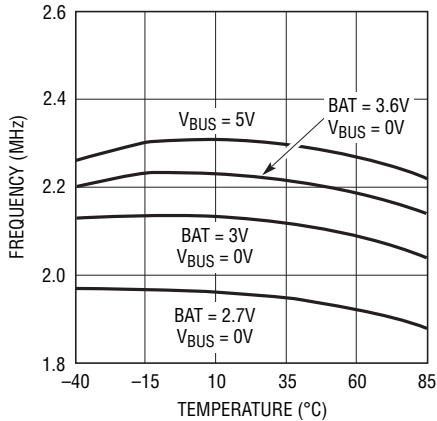

3586 G16

V_{BUS} Quiescent Current vs Temperature

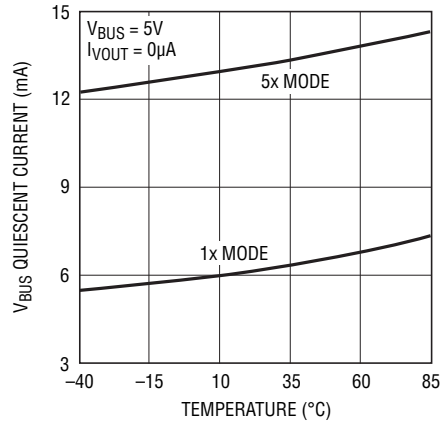

3586 G17

V_{BUS} Quiescent Current in Suspend vs Temperature

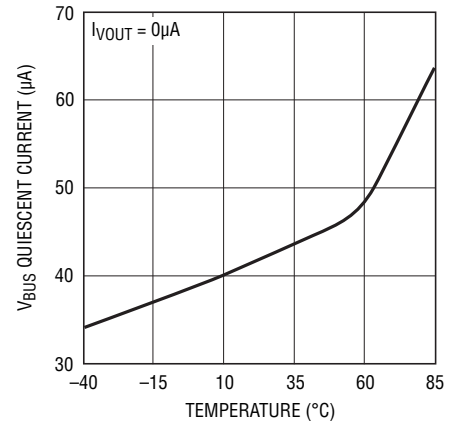

3586 G18

CHRG Pin Current vs Voltage (Pull-Down State)

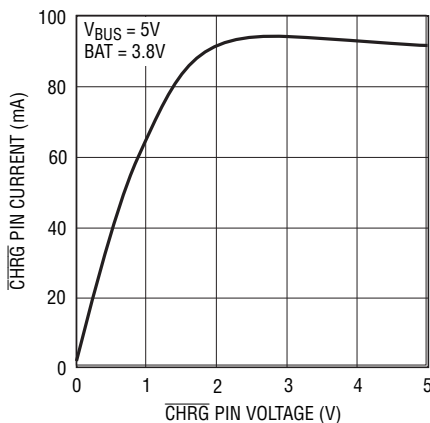

3586 G19

3.3V LDO Step Response (5mA to 15mA)

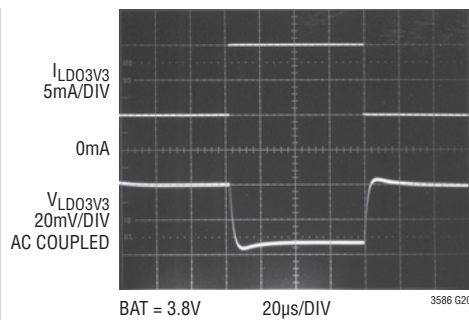

3586 G20

Battery Drain Current vs Temperature

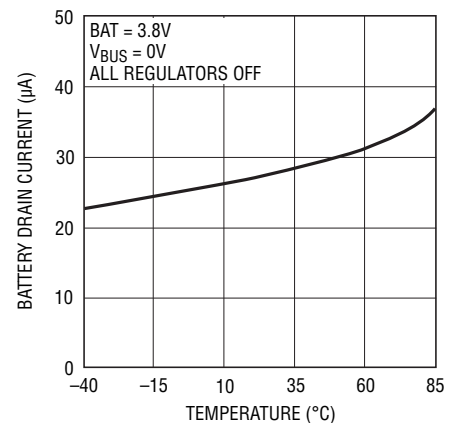

3586 G21

TYPICAL PERFORMANCE CHARACTERISTICS ($T_A = 25^\circ\text{C}$ unless otherwise noted)

Switching Regulators 1, 2 Pulse-Skip Mode Quiescent Currents

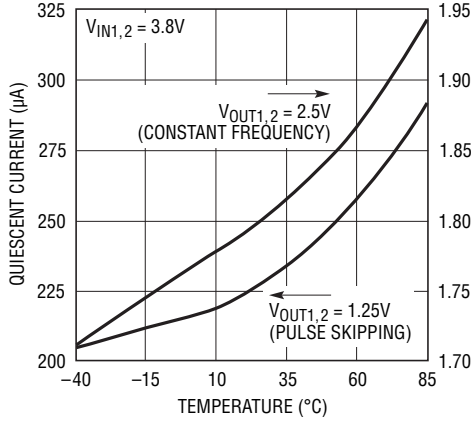

3586 G22

Switching Regulators 1, 2 Pulse-Skip Mode Efficiency

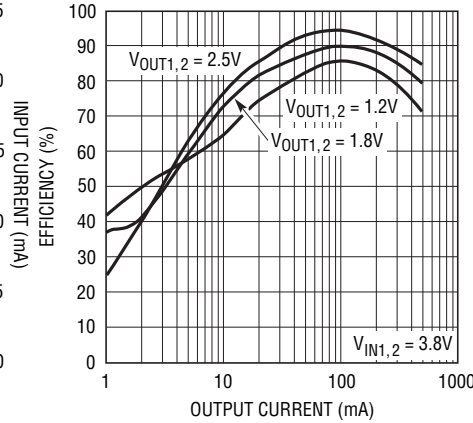

3586 G23

Switching Regulators 1, 2 Burst Mode Efficiency

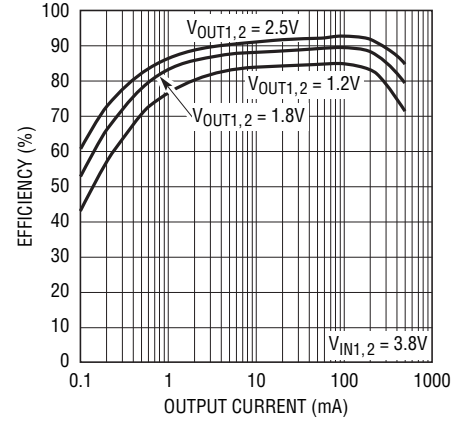

3586 G24

Switching Regulators 1, 2 Load Regulation at $V_{OUT1,2} = 1.2\text{V}$

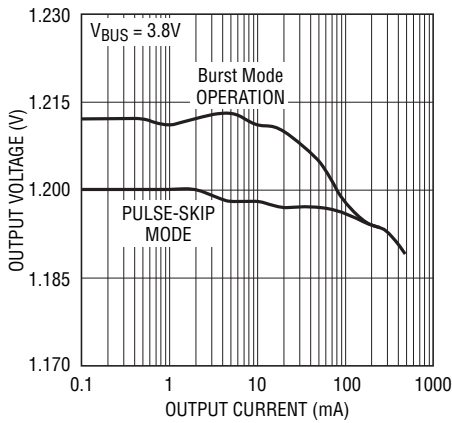

3586 G25

Switching Regulators 1, 2 Load Regulation at $V_{OUT1,2} = 1.8\text{V}$

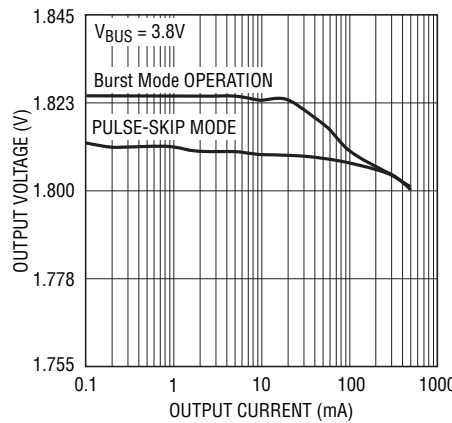

3586 G26

Switching Regulators 1, 2 Load Regulation at $V_{OUT1,2} = 2.5\text{V}$

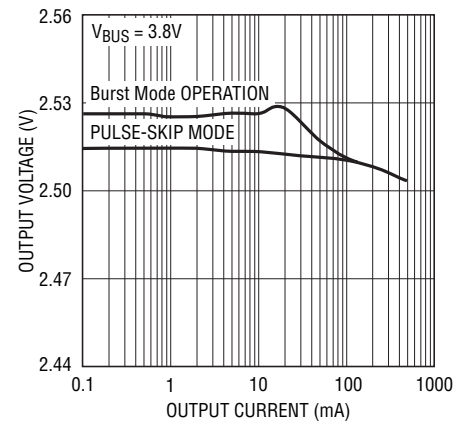

3586 G27

Buck-Boost Regulator Efficiency vs I_{LOAD}

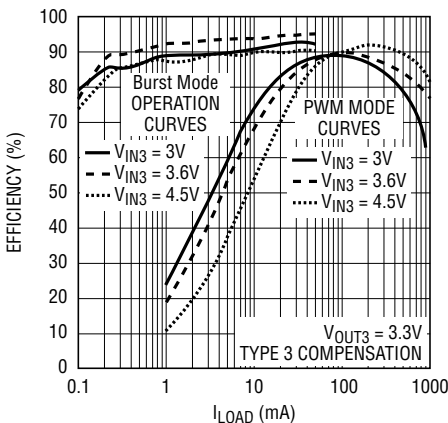

3586 G28

$R_{DS(ON)}$ For Buck-Boost Regulator

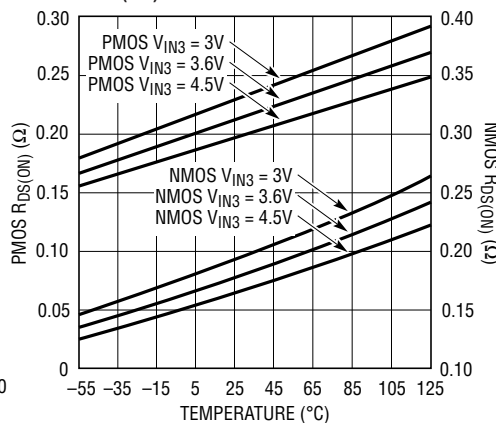

3586 G29

Buck-Boost Regulator Forward Current Limit

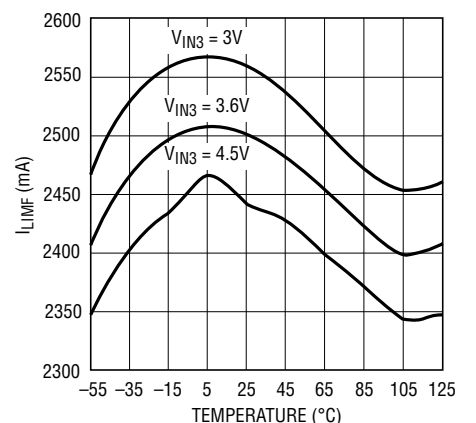

3586 G30

TYPICAL PERFORMANCE CHARACTERISTICS (T_A = 25°C unless otherwise noted.)

Buck-Boost Regulator Burst Mode Operation Quiescent Current

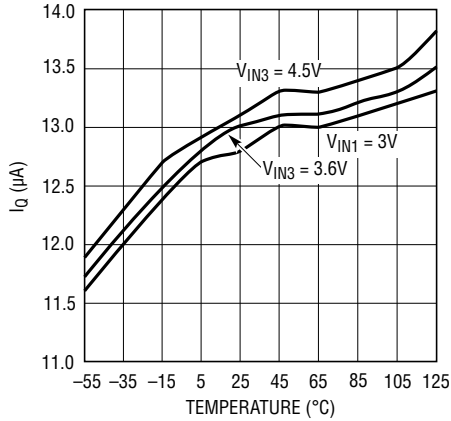

3586 G31

Reduction in Current Deliverability at Low V_{IN3}

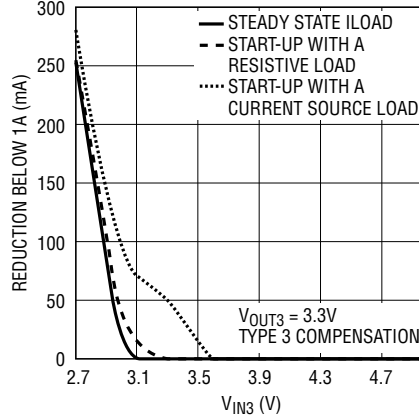

3586 G32

Buck-Boost Step Response

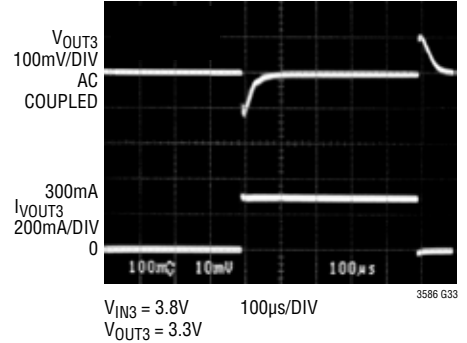

3586 G33

Boost Efficiency ($V_{IN4} = 3.8V$)

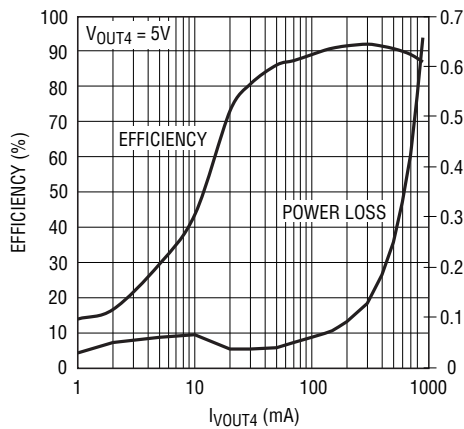

3586 G23

Boost Efficiency vs V_{IN4}

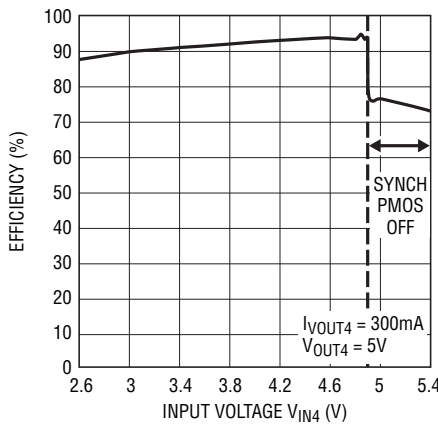

3586 G35

Boost Output Voltage vs Temperature

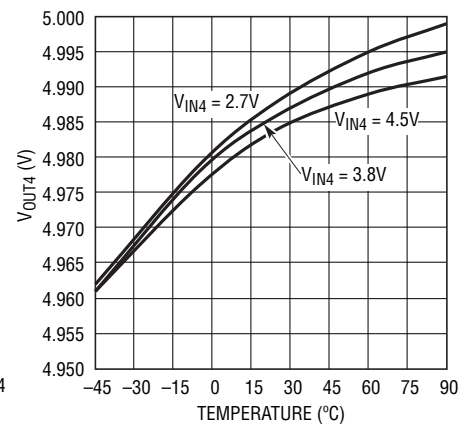

3586 G36

Maximum Deliverable Boost Output Current

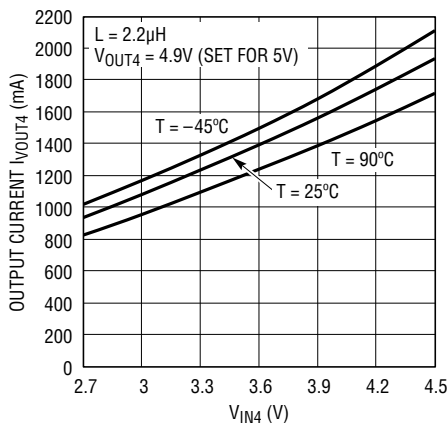

3586 G37

Maximum Boost Duty Cycle vs V_{IN4}

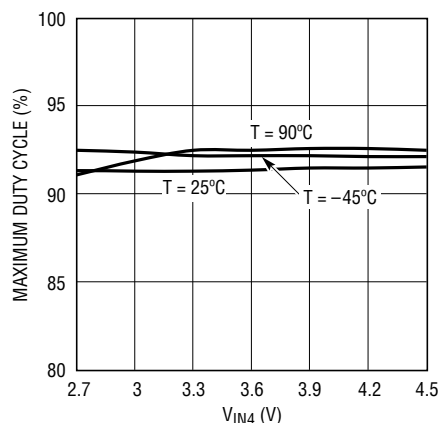

3586 G38

Boost Step Response (50mA to 300mA)

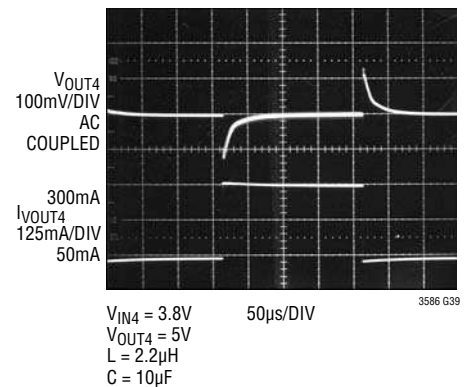

3586 G39

3586fb

PIN FUNCTIONS

I_{LIM0}, I_{LIM1} (Pins 1, 2): Logic Inputs. I_{LIM0} and I_{LIM1} control the current limit of the PowerPath switching regulator. See Table 1.

Table 1. USB Current Limit Settings

(I _{LIM1})	(I _{LIM0})	USB SETTING
0	0	1x Mode (USB 100mA Limit)
0	1	10x Mode (Wall 1A Limit)
1	0	Suspend
1	1	5x Mode (USB 500mA Limit)

LDO3V3 (Pin 3): 3.3V LDO Output Pin. This pin provides a regulated always-on 3.3V supply voltage. LDO3V3 gets its power from V_{OUT}. It may be used for light loads such as a watch dog microprocessor or real time clock. A 1μF capacitor is required from LDO3V3 to ground. If the LDO3V3 output is not used it should be disabled by connecting it to V_{OUT}.

CLPROG (Pin 4): USB Current Limit Program and Monitor Pin. A resistor from CLPROG to ground determines the upper limit of the current drawn from the V_{BUS} pin. A fraction of the V_{BUS} current is sent to the CLPROG pin when the synchronous switch of the PowerPath switching regulator is on. The switching regulator delivers power until the CLPROG pin reaches 1.188V. Several V_{BUS} current limit settings are available via user input which will typically correspond to the 500mA and 100mA USB specifications. A multilayer ceramic averaging capacitor is required at CLPROG for filtering.

NTC (Pin 5): Input to the Thermistor Monitoring Circuits. The NTC pin connects to a battery's thermistor to determine if the battery is too hot or too cold to charge. If the battery's temperature is out of range, charging is paused until it re-enters the valid range. A low drift bias resistor is required from V_{BUS} to NTC and a thermistor is required from NTC to ground. If the NTC function is not desired, the NTC pin should be grounded.

V_{OUT4} (Pins 6, 7): Power Output for the (Boost) Switching Regulator 4. A 10μF MLCC capacitor should be placed as close to the pins as possible.

SW4 (Pin 8): Switch Node for the (Boost) Switching Regulator 4. An external inductor connects between this pin and V_{IN4}.

MODE (Pin 9): Digital Input. The MODE pin controls different modes of operation for the switching regulators according to Table 2.

Table 2. Switching Regulators Mode

Mode	REGULATION MODE		
	Buck	Buck-Boost	Boost
0	Pulse-Skip	PWM	Pulse-Skip
1	Burst	Burst	Pulse-Skip

FB4 (Pin 10): Feedback Input for the (Boost) Switching Regulator 4. When the control loop is complete, the voltage on this pin serves to 0.8V.

FB3 (Pin 11): Feedback Input for (Buck-Boost) Switching Regulator 3. When regulator 3's control loop is complete, this pin serves to 0.8V.

V_{C3} (Pin 12): Output of the Error Amplifier and Voltage Compensation Node for (Buck-Boost) Switching Regulator 3. External Type I or Type III compensation (to FB3) connects to this pin. See the Applications Information section for selecting buck-boost compensation components.

SWAB3 (Pin 13): Switch Node for (Buck-Boost) Switching Regulator 3. Connected to Internal Power Switches A and B. An external inductor connects between this node and SWCD3.

V_{IN3} (Pins 14, 15): Power Input for (Buck-Boost) Switching Regulator 3. These pins will generally be connected to V_{OUT}. A 1μF MLCC capacitor is recommended on these pins.

V_{OUT3} (Pins 16, 17): Output Voltage for (Buck-Boost) Switching Regulator 3.

EN3 (Pin 18): Digital Input. This input enables the buck-boost switching regulator 3.

SWCD3 (Pin 19): Switch Node for (Buck-Boost) Switching Regulator 3 Connected to Internal Power Switches C and D. An external inductor connects between this node and SWAB3.

PIN FUNCTIONS

EN2 (Pin 20): Digital Input. This input enables the buck switching regulator 2.

EN1 (Pin 21): Digital Input. This input enables the buck switching regulator 1.

V_{IN4} (Pin 22): Power Input for Switching Regulator 4 (Boost). This pin will generally be connected to V_{OUT}. A 1μF MLCC capacitor is recommended on this pin.

FB2 (Pin 23): Feedback Input for (Buck) Switching Regulator 2. When regulator 2's control loop is complete, this pin serves to 0.8V.

V_{IN2} (Pin 24): Power Input for (Buck) Switching Regulator 2. This pin will generally be connected to V_{OUT}. A 1μF MLCC capacitor is recommended on this pin.

SW2 (Pin 25): Power Transmission Pin for (Buck) Switching Regulator 2.

SW1 (Pin 26): Power Transmission Pin for (Buck) Switching Regulator 1.

V_{IN1} (Pin 27): Power Input for (Buck) Switching Regulator 1. This pin will generally be connected to V_{OUT}. A 1μF MLCC capacitor is recommended on this pin.

FB1 (Pin 28): Feedback Input for (Buck) Switching Regulator 1. When regulator 1's control loop is complete, this pin serves to 0.8V.

PROG (Pin 29): Charge Current Program and Charge Current Monitor Pin. Connecting a resistor from PROG to ground programs the charge current. If sufficient input power is available in constant-current mode, this pin serves to 1V. The voltage on this pin always represents the actual charge current.

CHRG (Pin 30): Open-Drain Charge Status Output. The CHRG pin indicates the status of the battery charger. Four possible states are represented by $\overline{\text{CHRG}}$: charging, not charging, unresponsive battery and battery temperature out of range. CHRG is modulated at 35kHz and switches between a low and a high duty cycle for easy recognition by either humans or microprocessors. See Table 3. CHRG requires a pull-up resistor and/or LED to provide indication.

GATE (Pin 31): Analog Output. This pin controls the gate of an optional external P-channel MOSFET transistor used to supplement the ideal diode between V_{OUT} and BAT. The external ideal diode operates in parallel with the internal ideal diode. The source of the P-channel MOSFET should be connected to V_{OUT} and the drain should be connected to BAT. If the external ideal diode FET is not used, GATE should be left floating.

BAT (Pin 32): Single Cell Li-Ion Battery Pin. Depending on available V_{BUS} power, a Li-Ion battery on BAT will either deliver power to V_{OUT} through the ideal diode or be charged from V_{OUT} via the battery charger.

EN4 (Pin 33): Digital Input. This input enables the boost switching regulator 4.

V_{OUT} (Pin 34): Output Voltage of the Switching PowerPath Controller and Input Voltage of the Battery Charger. The majority of the portable product should be powered from V_{OUT}. The LTC3586/LTC3586-1 will partition the available power between the external load on V_{OUT} and the internal battery charger. Priority is given to the external load and any extra power is used to charge the battery. An ideal diode from BAT to V_{OUT} ensures that V_{OUT} is powered even if the load exceeds the allotted power from V_{BUS} or if the V_{BUS} power source is removed. V_{OUT} should be bypassed with a low impedance ceramic capacitor.

V_{BUS} (Pins 35, 36): Primary Input Power Pin. These pins deliver power to V_{OUT} via the SW pin by drawing controlled current from a DC source such as a USB port or wall adapter.

SW (Pin 37): Power Transmission Pin for the USB Power Path. The SW pin delivers power from V_{BUS} to V_{OUT} via the buck switching regulator. A 3.3μH inductor should be connected from SW to V_{OUT}.

$\overline{\text{FAULT}}$ (Pin 38): Bi-directional input/output (open-drain) used to alert or receive information from other power management ICs regarding an electrical fault.

GND (Exposed Pad Pin 39): Ground. The exposed pad should be connected to a continuous ground plane on the second layer of the printed circuit board by several vias directly under the LTC3586/LTC3586-1.

OPERATION

Introduction

The LTC3586/LTC3586-1 are highly integrated power management ICs which include a high efficiency switch mode PowerPath controller, a battery charger, an ideal diode, an always-on LDO, two 400mA buck switching regulators, a 1A buck-boost switching regulator, and an 800mA boost switching regulator. All of the regulators can be independently controlled via ENABLE pins.

Designed specifically for USB applications, the PowerPath controller incorporates a precision average input current buck switching regulator to make maximum use of the allowable USB power. Because power is conserved, the LTC3586/LTC3586-1 allow the load current on V_{OUT} to exceed the current drawn by the USB port without exceeding the USB load specifications.

The PowerPath switching regulator and battery charger communicate to ensure that the input current never violates the USB specifications.

The ideal diode from BAT to V_{OUT} guarantees that ample power is always available to V_{OUT} even if there is insufficient or absent power at V_{BUS} .

An always-on LDO provides a regulated 3.3V from available power at V_{OUT} . Drawing very little quiescent current, this LDO will be on at all times and can be used to supply up to 20mA.

Along with constant frequency PWM mode, the buck and the buck-boost switching regulators have a low power burst mode setting for significantly reduced quiescent current under light load conditions.

High Efficiency Switching PowerPath Controller

Whenever V_{BUS} is available and the PowerPath switching regulator is enabled, power is delivered from V_{BUS} to V_{OUT} via SW. V_{OUT} drives the combination of the external load (including switching regulators 1, 2, 3 and 4) and the battery charger.

If the combined load does not exceed the PowerPath switching regulator's programmed input current limit, V_{OUT} will track 0.3V above the battery (Bat-Track). By keeping

the voltage across the battery charger low, efficiency is optimized because power lost to the linear battery charger is minimized. Power available to the external load is therefore optimized.

If the combined load at V_{OUT} is large enough to cause the switching PowerPath supply to reach the programmed input current limit, the battery charger will reduce its charge current by that amount necessary to enable the external load to be satisfied. Even if the battery charge current is set to exceed the allowable USB current, the USB specification will not be violated. The PowerPath switching regulator will limit the average input current so that the USB specification is never violated. Furthermore, load current at V_{OUT} will always be prioritized and only excess available power will be used to charge the battery.

If the voltage at BAT is below 3.3V, or the battery is not present, and the load requirement does not cause the PowerPath switching regulator to exceed the USB specification, V_{OUT} will regulate at 3.6V, as shown in Figure 1. This "instant-on" feature will allow a portable product to run immediately when power is applied without waiting for the battery to charge. If the load exceeds the current limit at V_{BUS} , V_{OUT} will range between the no-load voltage and slightly below the battery voltage, indicated by the shaded region of Figure 1.

For very low-battery voltages, the battery charger acts like a load and, due to limited input power, its current will tend to pull V_{OUT} below the 3.6V "instant-on" voltage. To prevent V_{OUT} from falling below this level, an undervoltage circuit automatically detects that V_{OUT} is falling and reduces the battery charge as needed. This reduction ensures that load current and output voltages are always prioritized while allowing as much battery charge current as possible. See Over-Programming the Battery Charger in Applications Information Section.

The power delivered from V_{BUS} to V_{OUT} is controlled by a 2.25MHz constant-frequency buck switching regulator. To meet the USB maximum load specification, the switching regulator includes a control loop which ensures that the average input current is below the level programmed at CLPROG.

OPERATION

The current at CLPROG is a fraction (h_{CLPROG}^{-1}) of the V_{BUS} current. When a programming resistor and an averaging capacitor are connected from CLPROG to GND, the voltage on CLPROG represents the average input current of the PowerPath switching regulator. When the input current approaches the programmed limit, CLPROG reaches V_{CLPROG} , 1.188V and power out is held constant. The input current limit is programmed by the I_{LIM0} and I_{LIM1} pins to limit average input current to one of several possible settings as well as be deactivated (USB Suspend). The input current limit will be set by the V_{CLPROG} servo voltage and the resistor on CLPROG according to the following expression:

$$I_{VBUS} = I_{VBUSQ} + \frac{V_{CLPROG}}{R_{CLPROG}} \cdot (h_{CLPROG} + 1)$$

Figure 1 shows the range of possible voltages at V_{OUT} as a function of battery voltage.

Ideal Diode from BAT to V_{OUT}

The LTC3586/LTC3586-1 have an internal ideal diode as well as a controller for an optional external ideal diode. The ideal diode controller is always on and will respond quickly whenever V_{OUT} drops below BAT.

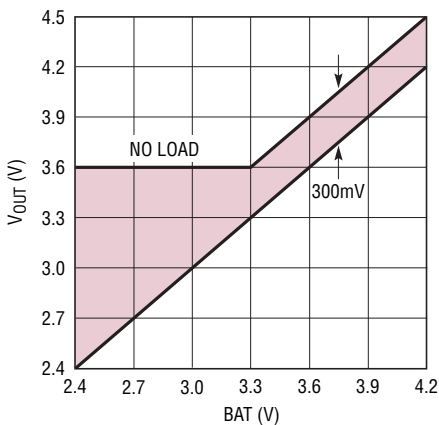

3586 F01

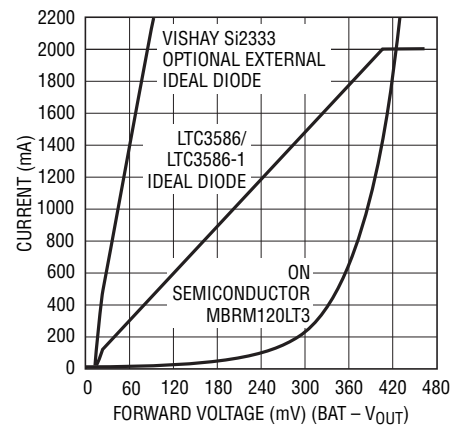
Figure 1. V_{OUT} vs BAT

3586 F02

Figure 2. Ideal Diode Operation

If the load current increases beyond the power allowed from the switching regulator, additional power will be pulled from the battery via the ideal diode. Furthermore, if power to V_{BUS} (USB or wall power) is removed, then all of the application power will be provided by the battery via the ideal diode. The transition from input power to battery power at V_{OUT} will be quick enough to allow only the 10 μ F capacitor to keep V_{OUT} from drooping. The ideal diode consists of a precision amplifier that enables a large on-chip P-channel MOSFET transistor whenever the voltage at V_{OUT} is approximately 15mV (V_{FWD}) below the voltage at BAT. The resistance of the internal ideal diode is approximately 180m Ω . If this is sufficient for the application, then no external components are necessary. However, if more conductance is needed, an external P-channel MOSFET transistor can be added from BAT to V_{OUT} . See Figure 2.

When an external P-channel MOSFET transistor is present, the GATE pin of the LTC3586/LTC3586-1 drive its gate for automatic ideal diode control. The source of the external P-channel MOSFET should be connected to V_{OUT} and the drain should be connected to BAT. Capable of driving a 1nF load, the GATE pin can control an external P-channel MOSFET transistor having an on-resistance of 40m Ω or lower.

OPERATION

Suspend LDO

If the LTC3586/LTC3586-1 are configured for USB suspend mode, the switching regulator is disabled and the suspend LDO provides power to the V_{OUT} pin (presuming there is power available to V_{BUS}). This LDO will prevent the battery from running down when the portable product has access to a suspended USB port. Regulating at 4.6V, this LDO only becomes active when the switching converter is disabled (Suspended). To remain compliant with the USB specification, the input to the LDO is current limited so that it will not exceed the 500 μ A low power suspend specification. If the load on V_{OUT} exceeds the suspend current limit, the additional current will come from the battery via the ideal diode.

3.3V Always-On Supply

The LTC3586/LTC3586-1 include a low quiescent current low dropout regulator that is always powered. This LDO can be used to provide power to a system pushbutton controller, standby microcontroller or real-time clock. Designed to deliver up to 20mA, the always-on LDO requires at least a 1 μ F low impedance ceramic bypass capacitor for compensation. The LDO is powered from V_{OUT} , and therefore will enter dropout at loads less than 20mA as V_{OUT} falls near 3.3V. If the LDO3V3 output is not used, it should be disabled by connecting it to V_{OUT} .

V_{BUS} Undervoltage Lockout (UVLO)

An internal undervoltage lockout circuit monitors V_{BUS} and keeps the PowerPath switching regulator off until V_{BUS} rises above 4.30V and is about 200mV above the battery voltage. Hysteresis on the UVLO turns off the regulator if V_{BUS} drops below 4.00V or to within 50mV of BAT. When this happens, system power at V_{OUT} will be drawn from the battery via the ideal diode.

Battery Charger

The LTC3586/LTC3586-1 include a constant-current/constant-voltage battery charger with automatic recharge, automatic termination by safety timer, low voltage trickle charging, bad cell detection and thermistor sensor input for out-of-temperature charge pausing.

Battery Preconditioning

When a battery charge cycle begins, the battery charger first determines if the battery is deeply discharged. If the battery voltage is below V_{TRKL} , typically 2.85V, an automatic trickle charge feature sets the battery charge current to 10% of the programmed value. If the low voltage persists for more than 1/2 hour, the battery charger automatically terminates and indicates via the CHRG pin that the battery was unresponsive.

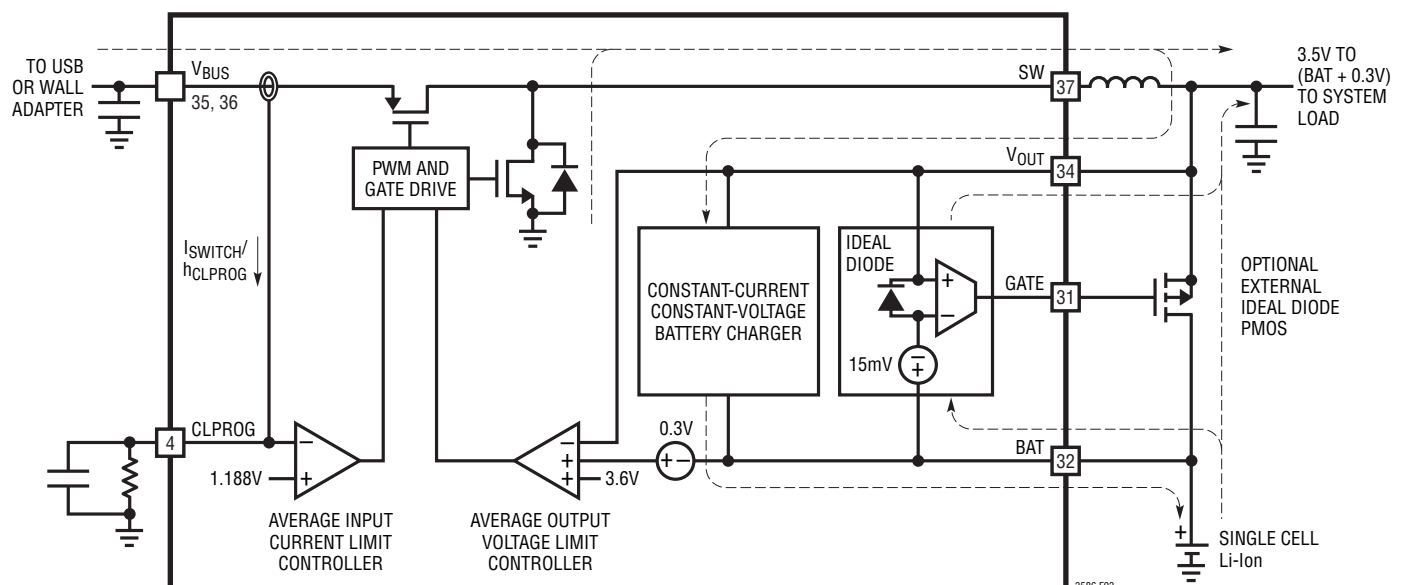

Figure 3. PowerPath Block Diagram

3586fb

OPERATION

Once the battery voltage is above 2.85V, the battery charger begins charging in full power constant-current mode. The current delivered to the battery will try to reach $1022V/R_{PROG}$. Depending on available input power and external load conditions, the battery charger may or may not be able to charge at the full programmed rate. The external load will always be prioritized over the battery charge current. The USB current limit programming will always be observed and only additional power will be available to charge the battery. When system loads are light, battery charge current will be maximized.

Charge Termination

The battery charger has a built-in safety timer. When the voltage on the battery reaches the pre-programmed float voltage, the battery charger will regulate the battery voltage and the charge current will decrease naturally. Once the battery charger detects that the battery has reached the float voltage, the four hour safety timer is started. After the safety timer expires, charging of the battery will discontinue and no more current will be delivered.

Automatic Recharge

After the battery charger terminates, it will remain off drawing only microamperes of current from the battery. If the portable product remains in this state long enough, the battery will eventually self discharge. To ensure that the battery is always topped off, a charge cycle will automatically begin when the battery voltage falls below the recharge threshold which is typically 100mV less than the charger's float voltage. In the event that the safety timer is running when the battery voltage falls below the recharge threshold, it will reset back to zero. To prevent brief excursions below the recharge threshold from resetting the safety timer, the battery voltage must be below the recharge threshold for more than 1.3ms. The charge cycle and safety timer will also restart if the V_{BUS} UVLO cycles low and then high (e.g., V_{BUS} is removed and then replaced).

Charge Current

The charge current is programmed using a single resistor from PROG to ground. $1/1022$ th of the battery charge current is sent to PROG which will attempt to servo to 1.000V. Thus, the battery charge current will try to reach 1022 times the current in the PROG pin. The program resistor and the charge current are calculated using the following equations:

$$R_{PROG} = \frac{1022V}{I_{CHG}}, I_{CHG} = \frac{1022V}{R_{PROG}}$$

In either the constant-current or constant-voltage charging modes, the voltage at the PROG pin will be proportional to the actual charge current delivered to the battery. Therefore, the actual charge current can be determined at any time by monitoring the PROG pin voltage and using the following equation:

$$I_{BAT} = \frac{V_{PROG}}{R_{PROG}} \cdot 1022$$

In many cases, the actual battery charge current, I_{BAT} , will be lower than I_{CHG} due to limited input power available and prioritization with the system load drawn from V_{OUT} .

Charge Status Indication

The \overline{CHRG} pin indicates the status of the battery charger. Four possible states are represented by \overline{CHRG} which include charging, not charging, unresponsive battery, and battery temperature out of range.

The signal at the \overline{CHRG} pin can be easily recognized as one of the above four states by either a human or a microprocessor. An open-drain output, the \overline{CHRG} pin can drive an indicator LED through a current limiting resistor for human interfacing or simply a pull-up resistor for microprocessor interfacing.

OPERATION

To make the $\overline{\text{CHRG}}$ pin easily recognized by both humans and microprocessors, the pin is either LOW for charging, HIGH for not charging, or it is switched at high frequency (35kHz) to indicate the two possible faults, unresponsive battery and battery temperature out of range.

When charging begins, $\overline{\text{CHRG}}$ is pulled low and remains low for the duration of a normal charge cycle. When charging is complete, i.e., the BAT pin reaches the float voltage and the charge current has dropped to one tenth of the programmed value, the $\overline{\text{CHRG}}$ pin is released (Hi-Z). If a fault occurs, the pin is switched at 35kHz. While switching, its duty cycle is modulated between a high and low value at a very low frequency. The low and high duty cycles are disparate enough to make an LED appear to be on or off thus giving the appearance of “blinking”. Each of the two faults has its own unique “blink” rate for human recognition as well as two unique duty cycles for machine recognition.

The $\overline{\text{CHRG}}$ pin does not respond to the C/10 threshold if the LTC3586/LTC3586-1 are in V_{BUS} current limit. This prevents false end-of-charge indications due to insufficient power available to the battery charger.

Table 3 illustrates the four possible states of the $\overline{\text{CHRG}}$ pin when the battery charger is active.

Table 3. $\overline{\text{CHRG}}$ Signal

STATUS	FREQUENCY	MODULATION (BLINK) FREQUENCY	DUTY CYCLES
Charging	0Hz	0Hz (Lo-Z)	100%
Not Charging	0Hz	0Hz (Hi-Z)	0%
NTC Fault	35kHz	1.5Hz at 50%	6.25% to 93.75%
Bad Battery	35kHz	6.1Hz at 50%	12.5% to 87.5%

An NTC fault is represented by a 35kHz pulse train whose duty cycle varies between 6.25% and 93.75% at a 1.5Hz rate. A human will easily recognize the 1.5Hz rate as a “slow” blinking which indicates the out-of-range battery temperature while a microprocessor will be able to decode either the 6.25% or 93.75% duty cycles as an NTC fault.

If a battery is found to be unresponsive to charging (i.e., its voltage remains below 2.85V for 1/2 hour), the $\overline{\text{CHRG}}$ pin gives the battery fault indication. For this fault, a human would easily recognize the frantic 6.1Hz “fast” blink of the LED while a microprocessor would be able to decode either the 12.5% or 87.5% duty cycles as a bad battery fault.

Note that the LTC3586/LTC3586-1 are 3-terminal PowerPath products where system load is always prioritized over battery charging. Due to excessive system load, there may not be sufficient power to charge the battery beyond the trickle charge threshold voltage within the bad battery timeout period. In this case, the battery charger will falsely indicate a bad battery. System software may then reduce the load and reset the battery charger to try again.

Although very improbable, it is possible that a duty cycle reading could be taken at the bright-dim transition (low duty cycle to high duty cycle). When this happens the duty cycle reading will be precisely 50%. If the duty cycle reading is 50%, system software should disqualify it and take a new duty cycle reading.

NTC Thermistor

The battery temperature is measured by placing a negative temperature coefficient (NTC) thermistor close to the battery pack.

To use this feature, connect the NTC thermistor, R_{NTC} , between the NTC pin and ground and a resistor, R_{NOM} , from V_{BUS} to the NTC pin. R_{NOM} should be a 1% resistor with a value equal to the value of the chosen NTC thermistor at 25°C (R25). A 100k thermistor is recommended since thermistor current is not measured by the LTC3586/LTC3586-1 and will have to be budgeted for USB compliance.

The LTC3586/LTC3586-1 will pause charging when the resistance of the NTC thermistor drops to 0.54 times the value of R25 or approximately 54k. For Vishay “Curve 1” thermistor, this corresponds to approximately 40°C. If the battery charger is in constant voltage (float) mode, the safety timer also pauses until the thermistor indicates a return to a valid temperature. As the temperature drops, the resistance of the NTC thermistor rises. The LTC3586/LTC3586-1 are also designed to pause charging when the value of the NTC thermistor increases to 3.25 times the value of R25. For Vishay “Curve 1” this resistance, 325k, corresponds to approximately 0°C. The hot and cold comparators each have approximately 3°C of hysteresis to prevent oscillation about the trip point. Grounding the NTC pin disables the NTC charge pausing function.

OPERATION

Thermal Regulation

To optimize charging time, an internal thermal feedback loop may automatically decrease the programmed charge current. This will occur if the die temperature rises to approximately 110°C. Thermal regulation protects the LTC3586/LTC3586-1 from excessive temperature due to high power operation or high ambient thermal conditions and allows the user to push the limits of the power handling capability with a given circuit board design without risk of damaging the LTC3586/LTC3586-1 or external components. The benefit of the LTC3586/LTC3586-1 thermal regulation loop is that charge current can be set according to actual conditions rather than worst-case conditions with the assurance that the battery charger will automatically reduce the current in worst-case conditions.

A flow chart of battery charger operation can be seen in Figure 4.

Low Supply Operation

The LTC3586/LTC3586-1 incorporate an undervoltage lockout circuit on V_{OUT} which shuts down all four general purpose switching regulators when V_{OUT} drops below $V_{OUTUVLO}$. This UVLO prevents unstable operation.

\overline{FAULT} Pin

\overline{FAULT} is a bi-directional pin with an open-drain output used to indicate a fault condition on any of the general purpose regulators. If any of the four regulators are enabled, and their corresponding FB pin voltage does not rise to within 8% of the internal reference voltage (0.8V) within 14ms, a fault condition will be reported by \overline{FAULT} going low. This, in turn, will disable all of the regulators. Alternatively, the regulators can be all disabled simultaneously by driving \overline{FAULT} low externally. This fault condition can be cleared only if all of the ENABLE inputs are pulled low for at least 3.6 μ s. Since \overline{FAULT} is an open-drain output, it requires a pull-up resistor to the input voltage of the monitoring microprocessor or another appropriate power source such as LD03V3.

If any of the ENABLE pins is tied high during start-up, the \overline{FAULT} pin can erroneously report a fault condition. To avoid such an event, the ENABLE pins should be tied high through a lowpass filter (comprised of a 1k resistor

and a 0.1 μ F capacitor) to the same power source to which \overline{FAULT} pin is pulled up.

General Purpose Buck Switching Regulators

The LTC3586/LTC3586-1 contain two 2.25MHz constant-frequency current mode buck switching regulators. Each buck regulator can provide up to 400mA of output current. Both buck regulators can be programmed for a minimum output voltage of 0.8V and can be used to power a microcontroller core, microcontroller I/O, memory, disk drive or other logic circuitry. Both buck converters support 100% duty cycle operation (low dropout mode) when their input voltage drops very close to their output voltage. To suit a variety of applications, selectable mode functions can be used to trade-off noise for efficiency. Two modes are available to control the operation of the LTC3586/LTC3586-1's buck regulators. At moderate to heavy loads, the pulse-skip mode provides the least noise switching solution. At lighter loads, Burst Mode operation may be selected. The buck regulators include soft-start to limit inrush current when powering on, short-circuit current protection and switch node slew limiting circuitry to reduce radiated EMI. No external compensation components are required. The operating mode of the buck regulators can be set by the MODE pin. The buck converters can be individually enabled by the EN1 and EN2 pins. Both buck regulators have a fixed feedback servo voltage of 800mV. The buck regulator input supplies V_{IN1} and V_{IN2} will generally be connected to the system load pin V_{OUT} .

Buck Regulator Output Voltage Programming

Both buck regulators can be programmed for output voltages greater than 0.8V. The output voltage for each buck regulator is programmed using a resistor divider from the buck regulator output connected to the feedback pins (FB1 and FB2) such that:

$$V_{OUTX} = V_{FBX} \left(\frac{R1}{R2} + 1 \right)$$

where V_{FB} is fixed at 0.8V and $X = 1, 2$. See Figure 4.

Typical values for R1 are in the range of 40k to 1M. The capacitor C_{FB} cancels the pole created by feedback resistors

OPERATION

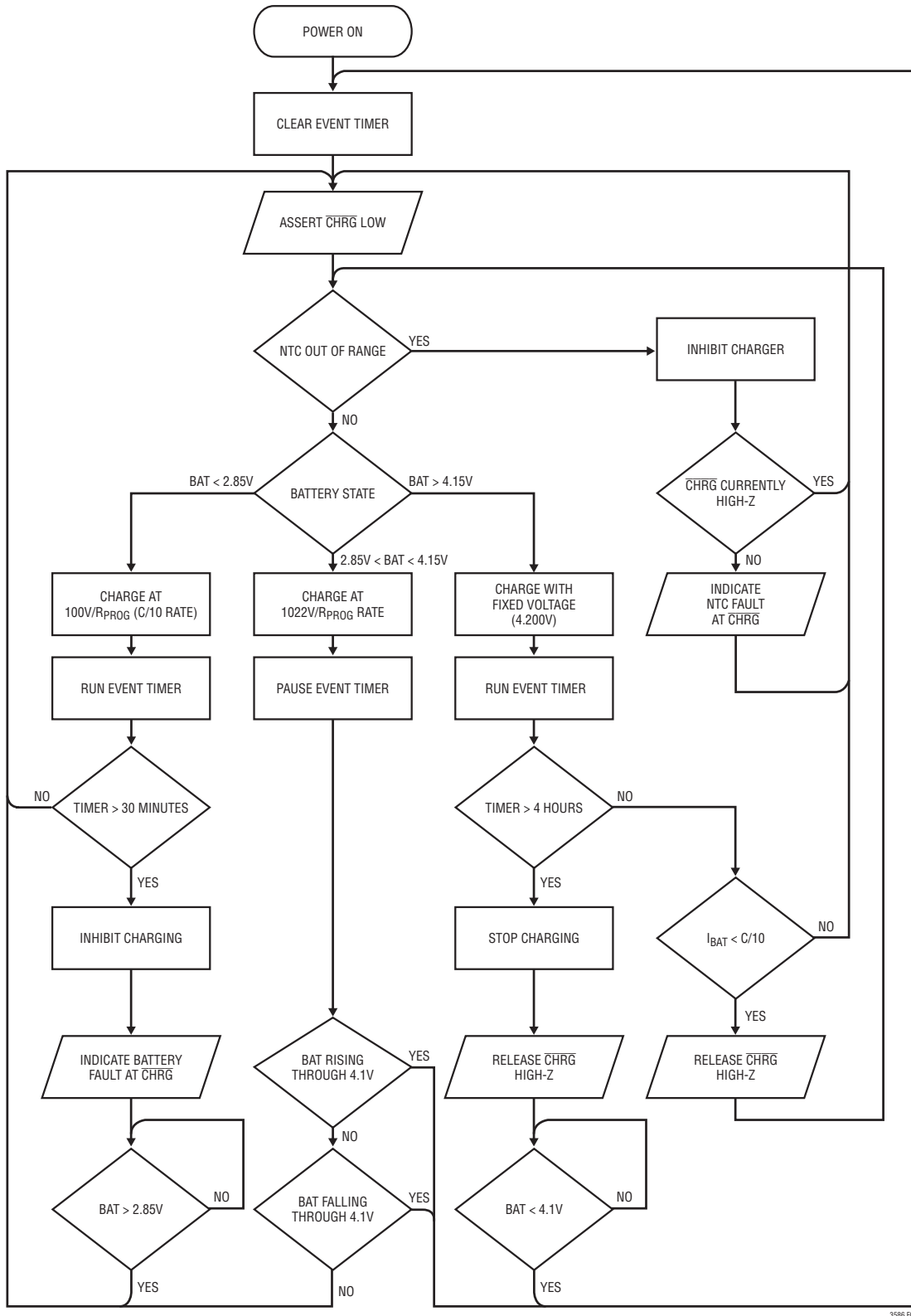

Figure 4. Flow Chart for Battery Charger Operation (LTC3586)

3586 F04

OPERATION

Buck Regulator Dropout Operation

It is possible for a buck regulator's input voltage, V_{INX} , to approach its programmed output voltage (e.g., a battery voltage of 3.4V with a programmed output voltage of 3.3V). When this happens, the PMOS switch duty cycle increases until it is turned on continuously at 100%. In this dropout condition, the respective output voltage equals the buck regulator's input voltage minus the voltage drops across the internal P-channel MOSFET and the inductor.

Buck Regulator Soft-Start Operation

Soft-start is accomplished by gradually increasing the peak inductor current for each buck regulator over a 500 μ s period. This allows each output to rise slowly, helping minimize the battery in-rush current. A soft-start cycle occurs whenever a given buck regulator is enabled, or after a fault condition has occurred (thermal shutdown or UVLO). A soft-start cycle is not triggered by changing operating modes. This allows seamless output operation when transitioning between modes.

Buck Regulator Switching Slew Rate Control

The buck regulators contain new patent pending circuitry to limit the slew rate of the switch node (SW1 and SW2). This new circuitry is designed to transition the switch node over a period of a couple of nanoseconds, significantly reducing radiated EMI and conducted supply noise.

BUCK-BOOST DC/DC SWITCHING REGULATOR

The LTC3586/LTC3586-1 contain a 2.25MHz constant-frequency voltage-mode buck-boost switching regulator. The regulator provides up to 1A of output load current. The buck-boost can be programmed to a minimum output voltage of 2.5V and can be used to power a microcontroller core, microcontroller I/O, memory, disk drive, or other logic circuitry. The converter is enabled by pulling EN3 high. To suit a variety of applications, a selectable mode function allows the user to trade-off noise for efficiency. Two modes are available to control the operation of the LTC3586/LTC3586-1's buck-boost regulator. At moderate to heavy loads, the constant frequency PWM mode provides the least noise switching solution. At lighter loads Burst Mode operation may be selected. The

output voltage is programmed by a user-supplied resistive divider returned to FB3. An error amplifier compares the divided output voltage with a reference and adjusts the compensation voltage accordingly until the FB3 pin has stabilized to the reference voltage (0.8V). The buck-boost regulator includes a soft-start to limit inrush current and voltage overshoot when powering on, short-circuit current protection, and switch node slew limiting circuitry for reduced radiated EMI.

Input Current Limit

The input current limit comparator will shut the input PMOS switch off once current exceeds 2.5A (typical). The 2.5A input current limit also protects against a grounded V_{OUT3} node.

Output Overvoltage Protection

If the FB3 node were inadvertently shorted to ground, then the output would increase indefinitely with the maximum current that could be sourced from V_{IN3} . The LTC3586/LTC3586-1 protect against this by shutting off the input PMOS if the output voltage exceeds 5.6V (typical).

Low Output Voltage Operation

When the output voltage is below 2.65V (typical) during start-up, Burst Mode operation is disabled and switch D is turned off (allowing forward current through the well diode and limiting reverse current to 0mA).

Buck-Boost Regulator PWM Operating Mode

In PWM mode the voltage seen at FB3 is compared to the reference voltage (0.8V). From the FB3 voltage an error amplifier generates an error signal seen at V_{C3} . This error signal commands PWM waveforms that modulate switches A, B, C, and D. Switches A and B operate synchronously as do switches C and D. If V_{IN3} is significantly greater than the programmed V_{OUT3} , then the converter will operate in buck mode. In this case switches A and B will be modulated, with switch D always on (and switch C always off), to step-down the input voltage to the programmed output. If V_{IN3} is significantly less than the programmed V_{OUT3} , then the converter will operate in boost mode. In this case switches C and D are modulated, with switch A

OPERATION

always on (and switch B always off), to step-up the input voltage to the programmed output. If V_{IN3} is close to the programmed V_{OUT3} , then the converter will operate in 4-switch mode. In this case the switches sequence through the pattern of AD, AC, BD to either step the input voltage up or down to the programmed output.

Buck-Boost Regulator Burst-Mode Operation

In Burst Mode operation, the buck-boost regulator uses a hysteretic FB3 voltage algorithm to control the output voltage. By limiting FET switching and using a hysteretic control loop, switching losses are greatly reduced. In this mode output current is limited to 50mA typical. While operating in Burst Mode operation, the output capacitor is charged to a voltage slightly higher than the regulation point. The buck-boost converter then goes into a sleep state, during which the output capacitor provides the load current. The output capacitor is charged by charging the inductor until the input current reaches 250mA typical and then discharging the inductor until the reverse current reaches 0mA typical. This process is repeated until the feedback voltage has charged to 6mV above the regulation point. In the sleep state, most of the regulator's circuitry is powered down, helping to conserve battery power. When the feedback voltage drops 6mV below the regulation point, the switching regulator circuitry is powered on and another burst cycle begins. The duration for which the regulator sleeps depends on the load current and output capacitor value. The sleep time decreases as the load current increases. The buck-boost regulator will not go to sleep if the current is greater than 50mA, and if the load current increases beyond this point while in Burst Mode operation the output will lose regulation. Burst Mode operation provides a significant improvement in efficiency at light loads at the expense of higher output ripple when compared to PWM mode. For many noise-sensitive systems, Burst Mode operation might be undesirable at certain times (i.e. during a transmit or receive cycle of a wireless device), but highly desirable at others (i.e. when the device is in low power standby mode). The MODE pin is used to enable or disable Burst Mode operation at any time, offering both low noise and low power operation when they are needed.

Buck-Boost Regulator Soft-Start Operation

Soft-start is accomplished by gradually increasing the maximum V_{C3} voltage over a 0.5ms (typical) period. Ramping the V_{C3} voltage limits the duty cycle and thus the V_{OUT3} voltage minimizing output overshoot during startup. A soft-start cycle occurs whenever the buck-boost is enabled, or after a fault condition has occurred (thermal shutdown or UVLO). A soft-start cycle is not triggered by changing operating modes. This allows seamless output operation when transitioning between Burst Mode operation and PWM mode.

SYNCHRONOUS BOOST DC/DC SWITCHING REGULATOR

The LTC3586/LTC3586-1 contain a 2.25MHz constant-frequency current mode synchronous boost switching regulator with true output disconnect feature. The regulator provides at least 800mA of output load current and the output voltage can be programmed up to a maximum of 5V. The converter is enabled by pulling EN4 high. The boost regulator also includes soft-start to limit inrush current and voltage overshoot when powering on, short circuit current protection and switch node slew limiting circuitry for reduced radiated EMI.

Error Amp

The boost output voltage is programmed by a user-supplied resistive divider returned to the FB4 pin. An internally compensated error amplifier compares the divided output voltage with an internal 0.8V reference and adjusts the voltage accordingly until FB4 servos to 0.8V.

Current Limit

Lossless current sensing converts the NMOS switch current signal to a voltage to be summed with the internal slope compensation signal. The summed signal is then compared to the error amplifier output to provide a peak current control command for the peak comparator. Peak switch current is limited to 2.4A independent of output voltage.

OPERATION

Zero Current Comparator

The zero current comparator monitors the inductor current to the output and shuts off the synchronous rectifier once the current drops to approximately 65mA. This prevents the inductor current from reversing in polarity thereby improving efficiency at light loads.

Antiringing Control

The antiringing control circuitry prevents high frequency ringing of the SW pin as the inductor current goes to zero in discontinuous mode. The damping of the resonant circuit formed by L and C_{SW} (capacitance of the SW4 pin) is achieved internally by switching a 150 Ω resistor across the inductor.

PMOS Synchronous Rectifier

To prevent the inductor current from running away, the PMOS synchronous rectifier is only enabled when $V_{OUT} > (V_{IN} + 130mV)$.

Output Disconnect and Inrush Limiting

The LTC3586/LTC3586-1 boost converter is designed to allow true output disconnect by eliminating body diode conduction of the internal PMOS rectifier. This allows V_{OUT} to go to zero volts during shutdown, drawing zero current from the input source. It also allows for inrush current limiting at start-up, minimizing surge currents seen by the input supply. Note that to obtain the advantage of output disconnect, there must not be an external Schottky diode connected between the SW4 and V_{OUT4} pin.

Short Circuit Protection

Unlike most boost converters, the LTC3586/LTC3586-1 boost converter allows its output to be short-circuited due to the output disconnect feature. It incorporates

internal features such as current limit foldback and thermal shutdown for protection from an excessive overload or short circuit.

$V_{IN} > V_{OUT}$ Operation

The LTC3586/LTC3586-1 boost converter will maintain voltage regulation even if the input voltage is above the output voltage. This is achieved by terminating the switching of the synchronous PMOS and applying V_{IN4} statically on its gate. This ensures that the slope of the inductor current will reverse during the time when current is flowing to the output. Since the PMOS no longer acts as a low impedance switch in this mode, there will be more power dissipation within the IC. This will cause a sharp drop in the efficiency (see Typical Performance Characteristics, Boost Efficiency vs V_{IN4}). The maximum output current should be limited in order to maintain an acceptable junction temperature.

Boost Soft-Start

The LTC3586/LTC3586-1 boost converter provides soft-start by slowly ramping the peak inductor current from zero to a maximum of 2.4A in about 500 μ s. Ramping the peak inductor current limits transient inrush currents during start-up. A soft-start cycle occurs whenever the boost is enabled, or after a fault condition has occurred (thermal shutdown or UVLO).

Boost Overvoltage Protection

If the FB4 node were inadvertently shorted to ground, then the boost converter output would increase indefinitely with the maximum current that could be sourced from V_{IN4} . The LTC3586/LTC3586-1 protects against this by shutting off the main switch if the output voltage exceeds 5.3V.

APPLICATIONS INFORMATION

PowerPath CONTROLLER APPLICATIONS SECTION

CLPROG Resistor and Capacitor

As described in the High Efficiency Switching PowerPath Controller section, the resistor on the CLPROG pin determines the average input current limit when the switching regulator is set to either the 1x mode (USB 100mA), the 5x mode (USB 500mA) or the 10x mode. The input current will be comprised of two components, the current that is used to drive V_{OUT} and the quiescent current of the switching regulator. To ensure that the USB specification is strictly met, both components of input current should be considered. The Electrical Characteristics table gives the worst-case values for quiescent currents in either setting as well as current limit programming accuracy. To get as close to the 500mA or 100mA specifications as possible, a 1% resistor should be used. Recall that $I_{VBUS} = I_{VBUSQ} + V_{CLPROG}/R_{CLPPROG} \cdot (h_{CLPROG} + 1)$.

An averaging capacitor is required in parallel with the CLPROG resistor so that the switching regulator can determine the average input current. This network also provides the dominant pole for the feedback loop when current limit is reached. To ensure stability, the capacitor on CLPROG should be 0.1 μ F.

Choosing the PowerPath Inductor

Because the input voltage range and output voltage range of the power path switching regulator are both fairly narrow, the LTC3586/LTC3586-1 are designed for a specific inductance value of 3.3 μ H. Some inductors which may be suitable for this application are listed in Table 4.

Table 4. Recommended Inductors for PowerPath Controller

INDUCTOR TYPE	L (μ H)	MAX I_{DC} (A)	MAX DCR (Ω)	SIZE IN mm (L \times W \times H)	MANUFACTURER
LPS4018	3.3	2.2	0.08	3.9 \times 3.9 \times 1.7	Coilcraft www.coilcraft.com
D53LC	3.3	2.26	0.034	5 \times 5 \times 3	Toko
DB318C	3.3	1.55	0.070	3.8 \times 3.8 \times 1.8	www.toko.com
WE-TPC Type M1	3.3	1.95	0.065	4.8 \times 4.8 \times 1.8	Würth Elektronik www.we-online.com
CDRH6D12	3.3	2.2	0.0625	6.7 \times 6.7 \times 1.5	Sumida
CDRH6D38	3.3	3.5	0.020	7 \times 7 \times 4	www.sumida.com

V_{BUS} and V_{OUT} Bypass Capacitors

The style and value of capacitors used with the LTC3586/LTC3586-1 determine several important parameters such as regulator control-loop stability and input voltage ripple. Because the LTC3586/LTC3586-1 use a buck switching power supply from V_{BUS} to V_{OUT} , its input current waveform contains high frequency components. It is strongly recommended that a low equivalent series resistance (ESR) multilayer ceramic capacitor be used to bypass V_{BUS} . Tantalum and aluminum capacitors are not recommended because of their high ESR. The value of the capacitor on V_{BUS} directly controls the amount of input ripple for a given load current. Increasing the size of this capacitor will reduce the input ripple.

To prevent large V_{OUT} voltage steps during transient load conditions, it is also recommended that a ceramic capacitor be used to bypass V_{OUT} . The output capacitor is used in the compensation of the switching regulator. At least 4 μ F of actual capacitance with low ESR are required on V_{OUT} . Additional capacitance will improve load transient performance and stability.

Multilayer ceramic chip capacitors typically have exceptional ESR performance. MLCCs combined with a tight board layout and an unbroken ground plane will yield very good performance and low EMI emissions.

There are several types of ceramic capacitors available each having considerably different characteristics. For example, X7R ceramic capacitors have the best voltage and temperature stability. X5R ceramic capacitors have apparently higher packing density but poorer performance over their rated voltage and temperature ranges. Y5V ceramic capacitors have the highest packing density, but must be used with caution, because of their extreme non-linear characteristic of capacitance versus voltage. The actual in-circuit capacitance of a ceramic capacitor should be measured with a small AC signal as is expected in-circuit. Many vendors specify the capacitance versus voltage with a 1V RMS AC test signal and as a result overstate the capacitance that the capacitor will present in the application. Using similar operating conditions as the application, the user must measure or request from the vendor the actual capacitance to determine if the selected capacitor meets the minimum capacitance that the application requires.

3586fb

APPLICATIONS INFORMATION

Over-Programming the Battery Charger

The USB high power specification allows for up to 2.5W to be drawn from the USB port (5V • 500mA). The PowerPath switching regulator transforms the voltage at V_{BUS} to just above the voltage at BAT with high efficiency, while limiting power to less than the amount programmed at CLPROG. In some cases the battery charger may be programmed (with the PROG pin) to deliver the maximum safe charging current without regard to the USB specifications. If there is insufficient current available to charge the battery at the programmed rate, the PowerPath regulator will reduce charge current until the system load on V_{OUT} is satisfied and the V_{BUS} current limit is satisfied. Programming the battery charger for more current than is available will not cause the average input current limit to be violated. It will merely allow the battery charger to make use of all available power to charge the battery as quickly as possible, and with minimal power dissipation within the battery charger.

Alternate NTC Thermistors and Biasing

The LTC3586/LTC3586-1 provide temperature qualified charging if a grounded thermistor and a bias resistor are connected to NTC. By using a bias resistor whose value is equal to the room temperature resistance of the thermistor (R25) the upper and lower temperatures are pre-programmed to approximately 40°C and 0°C, respectively (assuming a Vishay “Curve 1” thermistor).

The upper and lower temperature thresholds can be adjusted by either a modification of the bias resistor value or by adding a second adjustment resistor to the circuit. If only the bias resistor is adjusted, then either the upper or the lower threshold can be modified but not both. The other trip point will be determined by the characteristics of the thermistor. Using the bias resistor in addition to an adjustment resistor, both the upper and the lower temperature trip points can be independently programmed with the constraint that the difference between the upper and lower temperature thresholds cannot decrease. Examples of each technique are given below.

NTC thermistors have temperature characteristics which are indicated on resistance-temperature conversion tables.

The Vishay-Dale thermistor NTHS0603N011-N1003F, used in the following examples, has a nominal value of 100k and follows the Vishay “Curve 1” resistance-temperature characteristic.

In the explanation below, the following notation is used.

R25 = Value of the Thermistor at 25°C

$R_{NTC|COLD}$ = Value of thermistor at the cold trip point

$R_{NTC|HOT}$ = Value of the thermistor at the hot trip point

r_{COLD} = Ratio of $R_{NTC|COLD}$ to R25

r_{HOT} = Ratio of $R_{NTC|COLD}$ to R25

R_{NOM} = Primary thermistor bias resistor (see Figure 6a)

R1 = Optional temperature range adjustment resistor (see Figure 6b)

The trip points for the LTC3586/LTC3586-1's temperature qualification are internally programmed at $0.349 \cdot V_{BUS}$ for the hot threshold and $0.765 \cdot V_{BUS}$ for the cold threshold. Therefore, the hot trip point is set when:

$$\frac{R_{NTC|HOT}}{R_{NOM} + R_{NTC|HOT}} \cdot V_{BUS} = 0.349 \cdot V_{BUS}$$

and the cold trip point is set when:

$$\frac{R_{NTC|COLD}}{R_{NOM} + R_{NTC|COLD}} \cdot V_{BUS} = 0.765 \cdot V_{BUS}$$

Solving these equations for $R_{NTC|COLD}$ and $R_{NTC|HOT}$ results in the following:

$$R_{NTC|HOT} = 0.536 \cdot R_{NOM}$$

and

$$R_{NTC|COLD} = 3.25 \cdot R_{NOM}$$

By setting R_{NOM} equal to R25, the above equations result in $r_{HOT} = 0.536$ and $r_{COLD} = 3.25$. Referencing these ratios to the Vishay Resistance-Temperature Curve 1 chart gives a hot trip point of about 40°C and a cold trip point of about 0°C. The difference between the hot and cold trip points is approximately 40°C.

APPLICATIONS INFORMATION

By using a bias resistor, R_{NOM} , different in value from R_{25} , the hot and cold trip points can be moved in either direction. The temperature span will change somewhat due to the non-linear behavior of the thermistor. The following equations can be used to easily calculate a new value for the bias resistor:

$$R_{NOM} = \frac{r_{HOT}}{0.536} \cdot R_{25}$$

$$R_{NOM} = \frac{r_{COLD}}{3.25} \cdot R_{25}$$

where r_{HOT} and r_{COLD} are the resistance ratios at the desired hot and cold trip points. Note that these equations are linked. Therefore, only one of the two trip points can be chosen, the other is determined by the default ratios designed in the IC. Consider an example where a 60°C hot trip point is desired.

From the Vishay Curve 1 R-T characteristics, r_{HOT} is 0.2488 at 60°C. Using the above equation, R_{NOM} should be set to 46.4k. With this value of R_{NOM} , the cold trip point is about 16°C. Notice that the span is now 44°C rather than the previous 40°C. This is due to the decrease in

“temperature gain” of the thermistor as absolute temperature increases.

The upper and lower temperature trip points can be independently programmed by using an additional bias resistor as shown in Figure 6b. The following formulas can be used to compute the values of R_{NOM} and $R1$:

$$R_{NOM} = \frac{r_{COLD} - r_{HOT}}{2.714} \cdot R_{25}$$

$$R1 = 0.536 \cdot R_{NOM} - r_{HOT} \cdot R_{25}$$

For example, to set the trip points to 0°C and 45°C with a Vishay Curve 1 thermistor choose:

$$R_{NOM} = \frac{3.266 - 0.4368}{2.714} \cdot 100k = 104.2k$$

the nearest 1% value is 105k:

$$R1 = 0.536 \cdot 105k - 0.4368 \cdot 100k = 12.6k$$

the nearest 1% value is 12.7k. The final circuit is shown in Figure 6b and results in an upper trip point of 45°C and a lower trip point of 0°C.

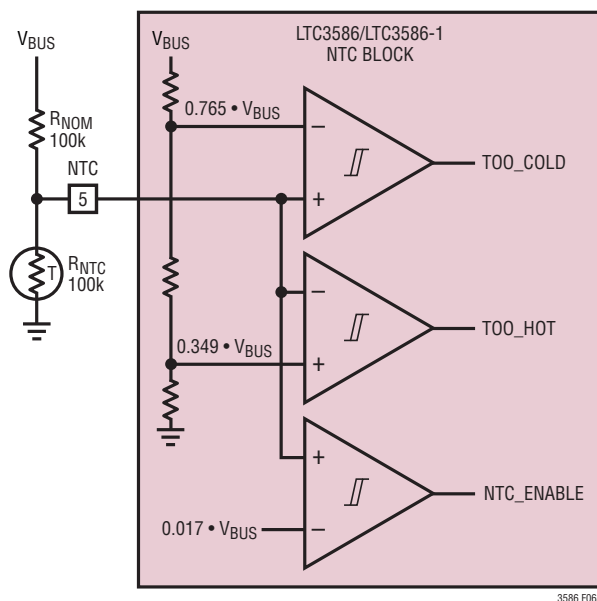

(6a)

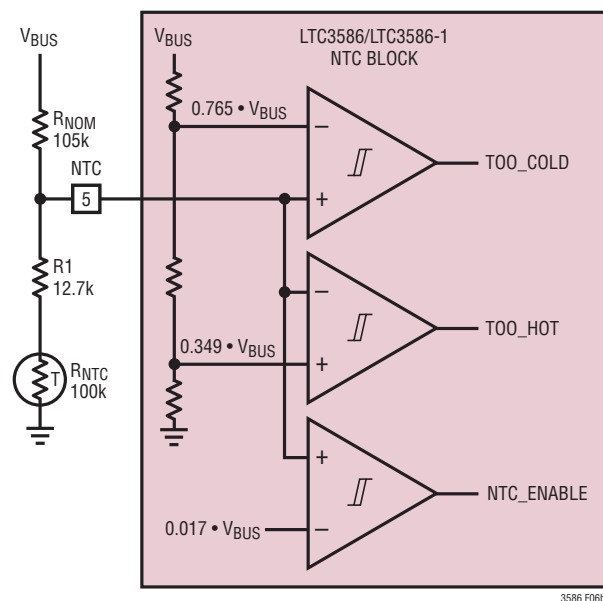

(6b)

Figure 6. NTC Circuits

APPLICATIONS INFORMATION

USB Inrush Limiting

When a USB cable is plugged into a portable product, the inductance of the cable and the high-Q ceramic input capacitor form an L-C resonant circuit. If the cable does not have adequate mutual coupling or if there is not much impedance in the cable, it is possible for the voltage at the input of the product to reach as high as twice the USB voltage (~10V) before it settles out. In fact, due to the high voltage coefficient of many ceramic capacitors, a nonlinearity, the voltage may even exceed twice the USB voltage. To prevent excessive voltage from damaging the LTC3586/LTC3586-1 during a hot insertion, it is best to have a low voltage coefficient capacitor at the V_{BUS} pin to the LTC3586/LTC3586-1. This is achievable by selecting an MLCC capacitor that has a higher voltage rating than that required for the application. For example, a 16V, X5R, 10 μ F capacitor in a 1206 case would be a better choice than a 6.3V, X5R, 10 μ F capacitor in a smaller 0805 case.

Alternatively, the soft connect circuit (Figure 7) can be employed. In this circuit, capacitor C1 holds MP1 off when the cable is first connected. Eventually C1 begins to charge up to the USB input voltage applying increasing gate support to MP1. The long time constant of R1 and C1 prevent the current from building up in the cable too fast thus dampening out any resonant overshoot.

Battery Charger Stability Considerations

The LTC3586/LTC3586-1's battery charger contains both a constant-voltage and a constant-current control loop. The constant-voltage loop is stable without any compensation when a battery is connected with low impedance leads. Excessive lead length, however, may add enough series inductance to require a bypass capacitor of at least 1 μ F from BAT to GND. Furthermore, when the battery is

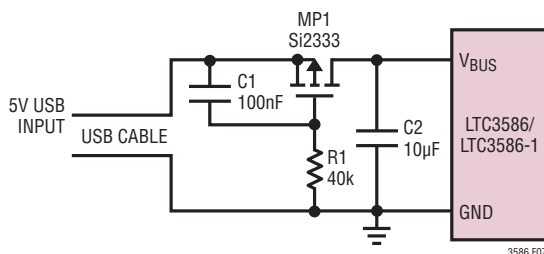

Figure 7. USB Soft Connect Circuit

disconnected, a 4.7 μ F capacitor in series with a 0.2 Ω to 1 Ω resistor from BAT to GND is required to keep ripple voltage low.

High value, low ESR multilayer ceramic chip capacitors reduce the constant-voltage loop phase margin, possibly resulting in instability. Ceramic capacitors up to 22 μ F may be used in parallel with a battery, but larger ceramics should be decoupled with 0.2 Ω to 1 Ω of series resistance.

In constant-current mode, the PROG pin is in the feedback loop rather than the battery voltage. Because of the additional pole created by any PROG pin capacitance, capacitance on this pin must be kept to a minimum. With no additional capacitance on the PROG pin, the battery charger is stable with program resistor values as high as 25k. However, additional capacitance on this node reduces the maximum allowed program resistor. The pole frequency at the PROG pin should be kept above 100kHz. Therefore, if the PROG pin has a parasitic capacitance, C_{PROG} , the following equation should be used to calculate the maximum resistance value for R_{PROG} :

$$R_{PROG} \leq \frac{1}{2\pi \cdot 100\text{kHz} \cdot C_{PROG}}$$

BUCK REGULATOR APPLICATIONS SECTION

Buck Regulator Inductor Selection

Many different sizes and shapes of inductors are available from numerous manufacturers. Choosing the right inductor from such a large selection of devices can be overwhelming, but following a few basic guidelines will make the selection process much simpler.

The buck converters are designed to work with inductors in the range of 2.2 μ H to 10 μ H. For most applications a 4.7 μ H inductor is suggested for both buck regulators.

Larger value inductors reduce ripple current which improves output ripple voltage. Lower value inductors result in higher ripple current and improved transient response time. To maximize efficiency, choose an inductor with a low DC resistance. For a 1.2V output, efficiency is reduced about 2% for 100m Ω series resistance at 400mA load current, and about 2% for 300m Ω series resistance at 100mA

APPLICATIONS INFORMATION

load current. Choose an inductor with a DC current rating at least 1.5 times larger than the maximum load current to ensure that the inductor does not saturate during normal operation. If output short circuit is a possible condition, the inductor should be rated to handle the maximum peak current specified for the buck converters.

Different core materials and shapes will change the size/current and price/current relationship of an inductor. Toroid or shielded pot cores in ferrite or Permalloy materials are small and don't radiate much energy, but generally cost more than powdered iron core inductors with similar electrical characteristics. Inductors that are very thin or have a very small volume typically have much higher core and DCR losses, and will not give the best efficiency. The choice of which style inductor to use often depends more on the price vs size, performance and any radiated EMI requirements than on what the LTC3586/LTC3586-1 require to operate.

The inductor value also has an effect on Burst Mode operations. Lower inductor values will cause the Burst Mode switching frequencies to increase.

Table 5 shows several inductors that work well with the LTC3586/LTC3586-1's buck regulators. These inductors offer a good compromise in current rating, DCR and physical size. Consult each manufacturer for detailed information on their entire selection of inductors.

Table 5. Recommended Inductors for Buck Regulators

INDUCTOR TYPE	L (μH)	MAX I _{DC} (A)	MAX DCR (Ω)	SIZE IN mm (L × W × H)	MANUFACTURER
DE2818C	4.7	1.25	0.072*	3.0 × 2.8 × 1.8	Toko www.toko.com
DE2812C	4.7	1.15	0.13*	3.0 × 2.8 × 1.2	
CDRH3D16	4.7	0.9	0.11	4 × 4 × 1.8	Sumida www.sumida.com
SD3118	4.7	1.3	0.162	3.1 × 3.1 × 1.8	Cooper www.cooperet.com
SD3112	4.7	0.8	0.246	3.1 × 3.1 × 1.2	
LPS3015	4.7	1.1	0.2	3.0 × 3.0 × 1.5	Coilcraft www.coilcraft.com

*Typical DCR

Buck Regulator Input/Output Capacitor Selection

Low ESR (equivalent series resistance) MLCC capacitors should be used at both buck regulator outputs as well as at each buck regulator input supply (V_{IN1} and V_{IN2}). Only X5R or X7R ceramic capacitors should be used because they retain their capacitance over wider voltage and temperature ranges than other ceramic types. A 10μF output capacitor is sufficient for most applications. For good transient response and stability the output capacitor should retain at least 4μF of capacitance over operating temperature and bias voltage. Each buck regulator input supply should be bypassed with a 1μF capacitor. Consult with capacitor manufacturers for detailed information on their selection and specifications of ceramic capacitors. Many manufacturers now offer very thin (<1mm tall) ceramic capacitors ideal for use in height-restricted designs. Table 6 shows a list of several ceramic capacitor manufacturers.

Table 6. Recommended Ceramic Capacitor Manufacturers

AVX	www.avxcorp.com
Murata	www.murata.com
Taiyo Yuden	www.t-yuden.com
Vishay Siliconix	www.vishay.com
TDK	www.tdk.com

BUCK-BOOST REGULATOR APPLICATIONS SECTION

Buck-Boost Regulator Inductor Selection

Inductor selection criteria for the buck-boost are similar to those given for the buck switching regulator. The buck-boost converter is designed to work with inductors in the range of 1μH to 5μH. For most applications a 2.2μH inductor will suffice. Choose an inductor with a DC current rating at least 2 times larger than the maximum load current to ensure that the inductor does not saturate during normal operation. If output short circuit is a possible condition, the inductor should be rated to handle the maximum peak current specified for the buck-boost converter.

Table 7 shows several inductors that work well with the LTC3586/LTC3586-1's buck-boost regulator. These inductors offer a good compromise in current rating, DCR and physical size. Consult each manufacturer for detailed information on their entire selection of inductors.

APPLICATIONS INFORMATION

Table 7. Recommended Inductors for Buck-Boost Regulator

INDUCTOR TYPE	L (μH)	MAX I _{DC} (A)	MAX DCR (Ω)	SIZE IN mm (L × W × H)	MANUFACTURER
LPS4018	3.3 2.2	2.2 2.5	0.08 0.07	3.9 × 3.9 × 1.7 3.9 × 3.9 × 1.7	Coilcraft www.coilcraft.com
D53LC	2.0	3.25	0.02	5.0 × 5.0 × 3.0	Toko www.toko.com
7440430022	2.2	2.5	0.028	4.8 × 4.8 × 2.8	Würth-Elektronik www.we-online.com
CDRH4D22/HP	2.2	2.4	0.044	4.7 × 4.7 × 2.4	Sumida www.sumida.com
SD14	2.0	2.56	0.045	5.2 × 5.2 × 1.45	Cooper www.cooperet.com

Buck-Boost Regulator Input/Output Capacitor Selection

Low ESR ceramic capacitors should be used at both the buck-boost regulator output (V_{OUT3}) as well as the buck-boost regulator input supply (V_{IN3}). Again, only X5R or X7R ceramic capacitors should be used because they retain their capacitance over wider voltage and temperature ranges than other ceramic types. A 22μF output capacitor is sufficient for most applications. The buck-boost regulator input supply should be bypassed with a 2.2μF capacitor. Refer to Table 6 for recommended ceramic capacitor manufacturers.

Buck-Boost Regulator Output Voltage Programming

The buck-boost regulator can be programmed for output voltages greater than 2.75V and less than 5.5V. The full scale output voltage is programmed using a resistor divider from the V_{OUT3} pin connected to the FB3 pin such that:

$$V_{OUT3} = V_{FB3} \left(\frac{R1}{R2} + 1 \right)$$

where V_{FB3} is 0.8V. See Figure 8 or 9.

Closing the Feedback Loop

The LTC3586/LTC3586-1 incorporate voltage mode PWM control. The control to output gain varies with operation region (buck, boost, buck-boost), but is usually no greater than 20. The output filter exhibits a double pole response given by:

$$f_{\text{FILTER_POLE}} = \frac{1}{2 \cdot \pi \cdot \sqrt{L \cdot C_{\text{OUT}}}} \text{ Hz}$$

where C_{OUT} is the output filter capacitor.

The output filter zero is given by:

$$f_{\text{FILTER_ZERO}} = \frac{1}{2 \cdot \pi \cdot R_{\text{ESR}} \cdot C_{\text{OUT}}} \text{ Hz}$$

where R_{ESR} is the capacitor equivalent series resistance.

A troublesome feature in boost mode is the right-half plane zero (RHP), and is given by:

$$f_{\text{RHPZ}} = \frac{V_{\text{IN}}^2}{2 \cdot \pi \cdot I_{\text{OUT}} \cdot L \cdot V_{\text{OUT}}} \text{ Hz}$$

The loop gain is typically rolled off before the RHP zero frequency.

A simple Type I compensation network (as shown in Figure 8) can be incorporated to stabilize the loop but at the cost of reduced bandwidth and slower transient response. To ensure proper phase margin, the loop must cross unity-gain decade before the LC double pole.

The unity-gain frequency of the error amplifier with the Type I compensation is given by:

$$f_{\text{UG}} = \frac{1}{2 \cdot \pi \cdot R1 \cdot CP1} \text{ Hz}$$

Most applications demand an improved transient response to allow a smaller output filter capacitor. To achieve a higher bandwidth, Type III compensation is required. Two zeros are required to compensate for the double-pole response. Type III compensation also reduces any V_{OUT3} overshoot seen during a startup condition.

APPLICATIONS INFORMATION

The compensation network depicted in Figure 9 yields the transfer function:

$$\frac{V_{C3}}{V_{OUT3}} = \frac{R1+R3}{R1 \cdot R3 \cdot C1} \cdot \frac{\left(s + \frac{1}{R2 \cdot C2}\right) \cdot \left(s + \frac{1}{(R1+R3) \cdot C3}\right)}{s \cdot \left(s + \frac{C1+C2}{R2 \cdot C1 \cdot C2}\right) \cdot \left(s + \frac{1}{R3 \cdot C3}\right)}$$

A Type III compensation network attempts to introduce a phase bump at a higher frequency than the LC double pole. This allows the system to cross unity gain after the LC double pole, and achieve a higher bandwidth. While attempting to crossover after the LC double pole, the system must still crossover before the boost right-half plane zero. If unity gain is not reached sufficiently before the right-half plane zero, then the -180° of phase from the LC double pole combined with the -90° of phase from the right-half plane zero will negate the phase bump of the compensator.

The compensator zeros should be placed either before or only slightly after the LC double pole such that their positive phase contributions of the compensation network offset the -180° that occurs at the filter double pole. If they are placed at too low of a frequency, however, they will introduce too much gain to the system and the crossover frequency will be too high. The two high frequency poles should be placed such that the system crosses unity gain during the phase bump introduced by the zeros yet before the boost right-half plane zero and such that the compensator bandwidth is less than the bandwidth of the error amp (typically 900kHz). If the gain of the compensation network is ever greater than the gain of the error amplifier, then the error amplifier no longer acts as an ideal op amp, another pole will be introduced where the gain crossover occurs, and the total compensation gain will not exceed that of the amplifier.

Recommended Type III Compensation Components for a 3.3V output:

R1: 324k

R_{FB}: 105k

C1: 10pF

R2: 15k

C2: 330pF

R3: 121k

C3: 33pF

C_{OUT}: 22μF

L_{OUT}: 2.2μH

BOOST REGULATOR APPLICATIONS SECTION

Boost Regulator Inductor Selection

The boost converter is designed to work with inductors in the range of 1μH to 5μH. For most applications a 2.2μH inductor will suffice. Larger value inductors will allow greater output current capability by reducing the inductor ripple current. However, using too large an inductor may push the right-half-plane zero too far inside and cause loop instability. Lower value inductors result in higher ripple current and improved transient response time. Refer to Table 7 for recommended inductors.

Boost Regulator Input/Output Capacitor Selection

Low ESR (equivalent series resistance) ceramic capacitors should be used at both the boost regulator output (V_{OUT4}) as well as the boost regulator input supply (V_{IN4}). Only X5R or X7R ceramic capacitors should be used because they retain their capacitance over wider voltage and temperature ranges than other ceramic types. At least 10μF of output capacitance at the rated output voltage is required to ensure stability of the boost converter output voltage over the entire temperature and load range. Refer to Table 6 for recommended ceramic capacitor manufacturers.

APPLICATIONS INFORMATION

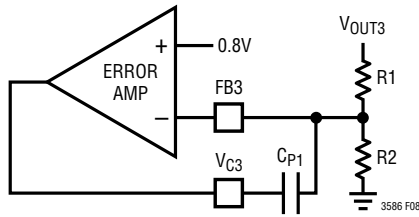

Figure 8. Error Amplifier with Type I Compensation

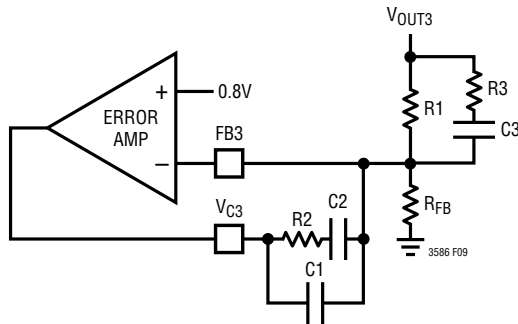

Figure 9. Error Amplifier with Type III Compensation

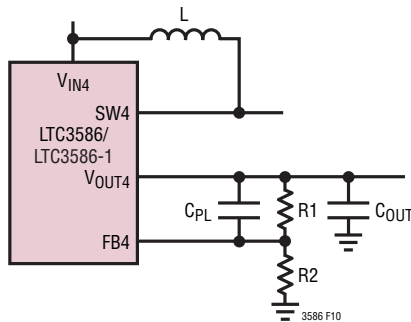

Figure 10. Boost Converter Application Circuit

Boost Regulator Output Voltage Programming

The boost regulator can be programmed for output voltages up to 5V. The output voltage is programmed using a resistor divider from the V_{OUT4} pin connected to the FB4 pin such that:

$$V_{OUT4} = V_{FB4} \left(\frac{R1}{R2} + 1 \right)$$

where V_{FB4} is 0.8V. See Figure 10.

Typical values for R1 are in the range of 40k to 1M. Too small a resistor will result in a large quiescent current in the feedback network and may hurt efficiency at low current. Too large a resistor coupled with the FB4 pin capacitance will create an additional pole which may result in loop instability. If large values are chosen for R1 and R2, a phase-lead capacitor, C_{PL} , across resistor R1 can improve the transient response. Recommended values for C_{PL} are in the range of 2pF to 10pF.

Printed Circuit Board Layout Considerations

In order to be able to deliver maximum current under all conditions, it is critical that the Exposed Pad on the backside of the LTC3586/LTC3586-1 packages be soldered to the PC board ground. Failure to make thermal contact between the Exposed Pad on the backside of the package and the copper board will result in higher thermal resistances.

APPLICATIONS INFORMATION

Furthermore, due to its high frequency switching circuitry, it is imperative that the input capacitors, inductors and output capacitors be as close to the LTC3586/LTC3586-1 as possible and that there be an unbroken ground plane under the LTC3586/LTC3586-1 and all of its external high frequency components. High frequency currents, such as the V_{BUS} , V_{IN1} , V_{IN2} , V_{IN3} , V_{OUT3} , and V_{OUT4} currents on the LTC3586/LTC3586-1, tend to find their way along the ground plane in a myriad of paths ranging from directly back to a mirror path beneath the incident path on the top of the board. If there are slits or cuts in the ground plane due to other traces on that layer, the current will be forced to go around the slits. If high frequency currents are not allowed to flow back through their natural least-area path, excessive voltage will build up and radiated

emissions will occur. There should be a group of vias under the grounded backside of the package leading directly down to an internal ground plane. To minimize parasitic inductance, the ground plane should be on the second layer of the PC board.

The GATE pin for the external ideal diode controller has extremely limited drive current. Care must be taken to minimize leakage to adjacent PC board traces. 100nA of leakage from this pin will introduce an offset to the 15mV ideal diode of approximately 10mV. To minimize leakage, the trace can be guarded on the PC board by surrounding it with V_{OUT} connected metal, which should generally be less than one volt higher than GATE.

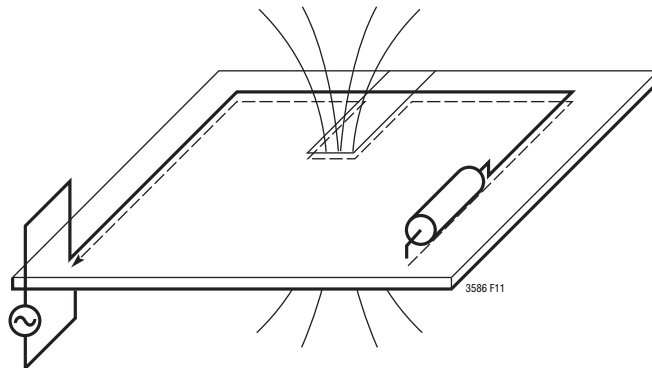

Figure 11. Higher Frequency Ground Currents Follow Their Incident Path. Slits in the Ground Plane Cause High Voltage and Increased Emissions

REVISION HISTORY (Revision history begins at Rev B)

REV	DATE	DESCRIPTION	PAGE NUMBER
B	03/10	Changes to Absolute Maximum Ratings Section	2
		Changes to Electrical Characteristics Section	3, 4, 5
		Changes to Pin Functions	12
		Changes to Related Parts Section	36

