

FEATURES

- **Gain-Bandwidth Product: 45MHz**
- **Slew Rate: 45V/ μ s**
- **Low Supply Current per Amplifier: 4.3mA**
- Input Common Mode Range Includes Both Rails
- Output Swings Rail-to-Rail
- Input Offset Voltage, Rail-to-Rail: 1350 μ V Max
- Input Offset Current: 440nA Max
- Input Bias Current: 2.2 μ A Max
- Open-Loop Gain: 800V/mV Min
- Low Input Noise Voltage: 12nV/ $\sqrt{\text{Hz}}$ Typ
- Low Distortion: -92dBc at 100kHz
- Wide Supply Range: 2.7V to \pm 15V
- Large Output Drive Current: 35mA Min
- Dual in 8-Pin PDIP and SO Packages

APPLICATIONS

- Active Filters
- Rail-to-Rail Buffer Amplifiers
- Driving A/D Converters
- Low Voltage Signal Processing
- Battery-Powered Systems

DESCRIPTION

The LT[®]1632/LT1633 are dual/quad, rail-to-rail input and output op amps with a 45MHz gain-bandwidth product and a 45V/ μ s slew rate.

The LT1632/LT1633 have excellent DC precision over the full range of operation. Input offset voltage is typically less than 400 μ V and the minimum open-loop gain of 0.8 million into a 10k load virtually eliminates all gain error. Common mode rejection is typically 83dB over the full rail-to-rail input range when on a single 5V supply for excellent noninverting performance.

The LT1632/LT1633 maintain their performance for supplies from 2.7V to 36V and are specified at 3V, 5V and \pm 15V supplies. The inputs can be driven beyond the supplies without damage or phase reversal of the output. The output delivers load currents in excess of 35mA.

The LT1632 is available in 8-pin PDIP and SO packages with the standard dual op amp pinout. The LT1633 features the standard quad op amp configuration and is available in a 14-pin plastic SO package. These devices can be used as plug-in replacements for many standard op amps to improve input/output range and performance.

LT, LTC and LT are registered trademarks of Linear Technology Corporation.

TYPICAL APPLICATION

Single Supply, 40dB Gain, 550kHz Instrumentation Amplifier

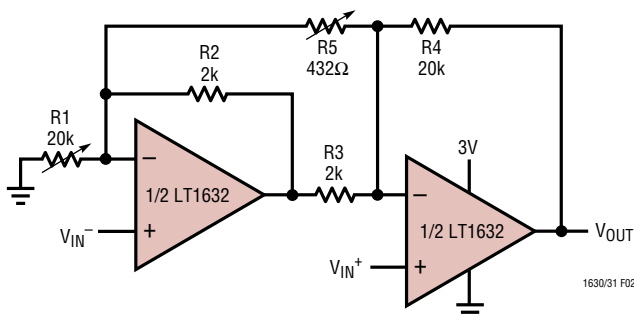

Frequency Response

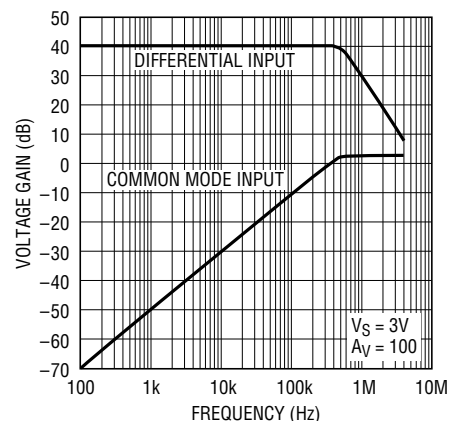

1632/33 TA02

sn1632 16323fs

ABSOLUTE MAXIMUM RATINGS (Note 1)

Total Supply Voltage (V^+ to V^-)	36V	Specified Temperature Range (Note 4)	-40°C to 85°C
Input Current	$\pm 10\text{mA}$	Junction Temperature	150°C
Output Short-Circuit Duration (Note 2)	Continuous	Storage Temperature Range	-65°C to 150°C
Operating Temperature Range	-40°C to 85°C	Lead Temperature (Soldering, 10 sec)	300°C

PACKAGE/ORDER INFORMATION

<p>N8 PACKAGE 8-LEAD PDIP</p> <p>S8 PACKAGE 8-LEAD PLASTIC SO</p> <p>$T_{JMAX} = 150^\circ\text{C}$, $\theta_{JA} = 130^\circ\text{C/W}$ (N8) $T_{JMAX} = 150^\circ\text{C}$, $\theta_{JA} = 190^\circ\text{C/W}$ (S8)</p>	ORDER PART NUMBER	<p>S PACKAGE 14-LEAD PLASTIC SO</p> <p>$T_{JMAX} = 150^\circ\text{C}$, $\theta_{JA} = 150^\circ\text{C/W}$</p>	ORDER PART NUMBER
	LT1632CN8 LT1632CS8 LT1632IN8 LT1632IS8		LT1633CS LT1633IS
	S8 PART MARKING		
	1632 1632I		

Consult factory for Military and Industrial grade parts.

ELECTRICAL CHARACTERISTICS

$T_A = 25^\circ\text{C}$, $V_S = 5\text{V}$, 0V ; $V_S = 3\text{V}$, 0V ; $V_{CM} = V_{OUT} = \text{half supply}$, unless otherwise noted.

SYMBOL	PARAMETER	CONDITIONS	MIN	TYP	MAX	UNITS
V_{OS}	Input Offset Voltage	$V_{CM} = V^+$ $V_{CM} = V^-$		400	1350	μV
				400	1350	μV
ΔV_{OS}	Input Offset Shift	$V_{CM} = V^- \text{ to } V^+$		350	1500	μV
	Input Offset Voltage Match (Channel-to-Channel)	$V_{CM} = V^-, V^+$ (Note 5)		500	2300	μV
I_B	Input Bias Current	$V_{CM} = V^+$ $V_{CM} = V^-$	0	1.15	2.2	μA
			-2.2	-1.15	0	μA
ΔI_B	Input Bias Current Shift	$V_{CM} = V^- \text{ to } V^+$		2.3	4.4	μA
	Input Bias Current Match (Channel-to-Channel)	$V_{CM} = V^+$ (Note 5) $V_{CM} = V^-$ (Note 5)		50	880	nA
I_{OS}	Input Offset Current	$V_{CM} = V^+$ $V_{CM} = V^-$		40	440	nA
				40	440	nA
ΔI_{OS}	Input Offset Current Shift	$V_{CM} = V^- \text{ to } V^+$		80	880	nA
	Input Noise Voltage	0.1Hz to 10Hz		400		nV _{p-p}
e_n	Input Noise Voltage Density	$f = 1\text{kHz}$		12		nV/ $\sqrt{\text{Hz}}$
i_n	Input Noise Current Density	$f = 1\text{kHz}$		1.6		pA/ $\sqrt{\text{Hz}}$
C_{IN}	Input Capacitance			5		pF
A_{VOL}	Large-Signal Voltage Gain	$V_S = 5\text{V}$, $V_O = 300\text{mV to } 4.7\text{V}$, $R_L = 10\text{k}$	450	2000		V/mV
		$V_S = 3\text{V}$, $V_O = 300\text{mV to } 2.7\text{V}$, $R_L = 10\text{k}$	350	1500		V/mV
CMRR	Common Mode Rejection Ratio	$V_S = 5\text{V}$, $V_{CM} = V^- \text{ to } V^+$	70	83		dB
		$V_S = 3\text{V}$, $V_{CM} = V^- \text{ to } V^+$	66	81		dB

ELECTRICAL CHARACTERISTICS

$T_A = 25^\circ\text{C}$, $V_S = 5\text{V}$, 0V ; $V_S = 3\text{V}$, 0V ; $V_{CM} = V_{OUT} = \text{half supply}$, unless otherwise noted.

SYMBOL	PARAMETER	CONDITIONS	MIN	TYP	MAX	UNITS
	CMRR Match (Channel-to-Channel) (Note 5)	$V_S = 5\text{V}$, $V_{CM} = V^- \text{ to } V^+$ $V_S = 3\text{V}$, $V_{CM} = V^- \text{ to } V^+$	65 61	85 82		dB dB
PSRR	Power Supply Rejection Ratio	$V_S = 2.7\text{V to } 12\text{V}$, $V_{CM} = V_O = 0.5\text{V}$	82	100		dB
	PSRR Match (Channel-to-Channel) (Note 5)	$V_S = 2.7\text{V to } 12\text{V}$, $V_{CM} = V_O = 0.5\text{V}$	79	101		dB
	Minimum Supply Voltage (Note 9)	$V_{CM} = V_O = 0.5\text{V}$		2.6	2.7	V
V_{OL}	Output Voltage Swing Low (Note 6)	No Load		15	30	mV
		$I_{SINK} = 0.5\text{mA}$		32	60	mV
		$I_{SINK} = 25\text{mA}$, $V_S = 5\text{V}$		600	1200	mV
		$I_{SINK} = 20\text{mA}$, $V_S = 3\text{V}$		500	1000	mV
V_{OH}	Output Voltage Swing High (Note 6)	No Load		16	40	mV
		$I_{SOURCE} = 0.5\text{mA}$		42	80	mV
		$I_{SOURCE} = 20\text{mA}$, $V_S = 5\text{V}$		910	1800	mV
		$I_{SOURCE} = 15\text{mA}$, $V_S = 3\text{V}$		680	1400	mV
I_{SC}	Short-Circuit Current	$V_S = 5\text{V}$	± 20	± 40		mA
		$V_S = 3\text{V}$	± 15	± 30		mA
I_S	Supply Current per Amplifier			4.3	5.2	mA
GBW	Gain-Bandwidth Product (Note 7)	$f = 100\text{kHz}$	22	45		MHz
SR	Slew Rate (Note 8)	$V_S = 5\text{V}$, $A_V = -1$, $R_L = \text{Open}$, $V_O = 4\text{V}$	13	27		V/ μs
		$V_S = 3\text{V}$, $A_V = -1$, $R_L = \text{Open}$	11	22		V/ μs
t_S	Settling Time	$V_S = 5\text{V}$, $A_V = 1$, $R_L = 1\text{k}$, 0.01% , $V_{STEP} = 2\text{V}$		400		ns

$0^\circ\text{C} < T_A < 70^\circ\text{C}$, $V_S = 5\text{V}$, 0V ; $V_S = 3\text{V}$, 0V ; $V_{CM} = V_{OUT} = \text{half supply}$, unless otherwise noted.

SYMBOL	PARAMETER	CONDITIONS	MIN	TYP	MAX	UNITS
V_{OS}	Input Offset Voltage	$V_{CM} = V^+ - 0.1\text{V}$		600	2000	μV
		$V_{CM} = V^- + 0.2\text{V}$		600	2000	μV
$V_{OS\ TC}$	Input Offset Voltage Drift (Note 3)			8	15	$\mu\text{V}/^\circ\text{C}$
		$V_{CM} = V^+ - 0.1\text{V}$		2.5	7	$\mu\text{V}/^\circ\text{C}$
ΔV_{OS}	Input Offset Voltage Shift	$V_{CM} = V^- + 0.2\text{V to } V^+ - 0.1\text{V}$		400	2300	μV
		Input Offset Voltage Match (Channel-to-Channel)	$V_{CM} = V^- + 0.2\text{V}$, $V^+ - 0.1\text{V}$ (Note 5)		700	3750
I_B	Input Bias Current	$V_{CM} = V^+ - 0.1\text{V}$	0	1.3	2.6	μA
		$V_{CM} = V^- + 0.2\text{V}$	-2.6	-1.3	0	μA
ΔI_B	Input Bias Current Shift	$V_{CM} = V^- + 0.2\text{V to } V^+ - 0.1\text{V}$		2.6	5.2	μA
		Input Bias Current Match (Channel-to-Channel)	$V_{CM} = V^+ - 0.1\text{V}$ (Note 5) $V_{CM} = V^- + 0.2\text{V}$ (Note 5)		50	1040
I_{OS}	Input Offset Current	$V_{CM} = V^+ - 0.1\text{V}$		40	520	nA
		$V_{CM} = V^- + 0.2\text{V}$		40	520	nA
ΔI_{OS}	Input Offset Current Shift	$V_{CM} = V^- + 0.2\text{V to } V^+ - 0.1\text{V}$		80	1040	nA
A_{VOL}	Large-Signal Voltage Gain	$V_S = 5\text{V}$, $V_O = 300\text{mV to } 4.7\text{V}$, $R_L = 10\text{k}$	300	1100		V/mV
		$V_S = 3\text{V}$, $V_O = 300\text{mV to } 2.7\text{V}$, $R_L = 10\text{k}$	200	1000		V/mV
CMRR	Common Mode Rejection Ratio	$V_S = 5\text{V}$, $V_{CM} = V^- + 0.2\text{V to } V^+ - 0.1\text{V}$	67	81		dB
		$V_S = 3\text{V}$, $V_{CM} = V^- + 0.2\text{V to } V^+ - 0.1\text{V}$	61	77		dB
	CMRR Match (Channel-to-Channel) (Note 5)	$V_S = 5\text{V}$, $V_{CM} = V^- + 0.2\text{V to } V^+ - 0.1\text{V}$	62	78		dB
		$V_S = 3\text{V}$, $V_{CM} = V^- + 0.2\text{V to } V^+ - 0.1\text{V}$	57	73		dB
PSRR	Power Supply Rejection Ratio	$V_S = 3\text{V to } 12\text{V}$, $V_{CM} = V_O = 0.5\text{V}$	81	94		dB
	PSRR Match (Channel-to-Channel) (Note 5)	$V_S = 3\text{V to } 12\text{V}$, $V_{CM} = V_O = 0.5\text{V}$	77	95		dB

sn1632 16323fs

ELECTRICAL CHARACTERISTICS

0°C < T_A < 70°C, V_S = 5V, 0V; V_S = 3V, 0V; V_{CM} = V_{OUT} = half supply, unless otherwise noted.

SYMBOL	PARAMETER	CONDITIONS	MIN	TYP	MAX	UNITS
	Minimum Supply Voltage (Note 9)	V _{CM} = V _O = 0.5V		2.6	2.7	V
V _{OL}	Output Voltage Swing Low (Note 6)	No Load		18	40	mV
		I _{SINK} = 0.5mA		37	80	mV
		I _{SINK} = 25mA, V _S = 5V		700	1400	mV
		I _{SINK} = 20mA, V _S = 3V		560	1200	mV
V _{OH}	Output Voltage Swing High (Note 6)	No Load		16	40	mV
		I _{SOURCE} = 0.5mA		50	100	mV
		I _{SOURCE} = 15mA, V _S = 5V		820	1600	mV
		I _{SOURCE} = 10mA, V _S = 3V		550	1100	mV
I _{SC}	Short-Circuit Current	V _S = 5V	±18	±37		mA
		V _S = 3V	±13	±26		mA
I _S	Supply Current per Amplifier			4.9	6.0	mA
GBW	Gain-Bandwidth Product (Note 7)	f = 100kHz	20	41		MHz
SR	Slew Rate (Note 8)	V _S = 5V, A _V = -1, R _L = Open, V _O = 4V	13	26		V/μs
		V _S = 3V, A _V = -1, R _L = Open	10	21		V/μs

-40°C < T_A < 85°C, V_S = 5V, 0V; V_S = 3V, 0V; V_{CM} = V_{OUT} = half supply, unless otherwise noted. (Note 4)

SYMBOL	PARAMETER	CONDITIONS	MIN	TYP	MAX	UNITS
V _{OS}	Input Offset Voltage	V _{CM} = V ⁺ - 0.1V		700	2400	μV
		V _{CM} = V ⁻ + 0.2V		700	2400	μV
V _{OS} TC	Input Offset Voltage Drift (Note 3)	V _{CM} = V ⁺ - 0.1V		8	15	μV/°C
		V _{CM} = V ⁻ + 0.2V		2.5	7	μV/°C
ΔV _{OS}	Input Offset Voltage Shift	V _{CM} = V ⁻ + 0.2V to V ⁺ - 0.1V		475	2500	μV
		V _{CM} = V ⁻ + 0.2V, V ⁺ (Note 5)		750	4000	μV
I _B	Input Bias Current	V _{CM} = V ⁺ - 0.1V	0	1.46	3.0	μA
		V _{CM} = V ⁻ + 0.2V	-3.0	-1.46	0	μA
ΔI _B	Input Bias Current Shift	V _{CM} = V ⁻ + 0.2V to V ⁺ - 0.1V		2.92	6.0	μA
		V _{CM} = V ⁺ - 0.1V (Note 5)		70	1160	nA
	Input Bias Current Match (Channel-to-Channel)	V _{CM} = V ⁻ + 0.2V (Note 5)		70	1160	nA
I _{OS}	Input Offset Current	V _{CM} = V ⁺ - 0.1V		75	580	nA
		V _{CM} = V ⁻ + 0.2V		75	580	nA
ΔI _{OS}	Input Offset Current Shift	V _{CM} = V ⁻ + 0.2V to V ⁺ - 0.1V		50	1160	nA
A _{VOL}	Large-Signal Voltage Gain	V _S = 5V, V _O = 300mV to 4.7V, R _L = 10k	250	1000		V/mV
		V _S = 3V, V _O = 300mV to 2.7V, R _L = 10k	200	800		V/mV
CMRR	Common Mode Rejection Ratio	V _S = 5V, V _{CM} = V ⁻ + 0.2V to V ⁺ - 0.1V	65	80		dB
		V _S = 3V, V _{CM} = V ⁻ + 0.2V to V ⁺ - 0.1V	60	75		dB
	CMRR Match (Channel-to-Channel) (Note 5)	V _S = 5V, V _{CM} = V ⁻ + 0.2V to V ⁺ - 0.1V	62	78		dB
		V _S = 3V, V _{CM} = V ⁻ + 0.2V to V ⁺ - 0.1V	57	73		dB
PSRR	Power Supply Rejection Ratio	V _S = 3V to 12V, V _{CM} = V _O = 0.5V	79	95		dB
		V _S = 3V to 12V, V _{CM} = V _O = 0.5V	75	95		dB
	Minimum Supply Voltage (Note 9)	V _{CM} = V _O = 0.5V		2.6	2.7	V
V _{OL}	Output Voltage Swing Low (Note 6)	No Load		19	40	mV
		I _{SINK} = 0.5mA		39	80	mV
		I _{SINK} = 25mA, V _S = 5V		730	1500	mV
		I _{SINK} = 20mA, V _S = 3V		580	1200	mV

ELECTRICAL CHARACTERISTICS

$-40^{\circ}\text{C} < T_A < 85^{\circ}\text{C}$, $V_S = 5\text{V}, 0\text{V}$; $V_S = 3\text{V}, 0\text{V}$; $V_{CM} = V_{OUT} = \text{half supply}$, unless otherwise noted. (Note 4)

SYMBOL	PARAMETER	CONDITIONS	MIN	TYP	MAX	UNITS
V_{OH}	Output Voltage Swing High (Note 6)	No Load		16	40	mV
		$I_{SOURCE} = 0.5\text{mA}$		55	110	mV
		$I_{SOURCE} = 15\text{mA}$, $V_S = 5\text{V}$		860	1700	mV
		$I_{SOURCE} = 10\text{mA}$, $V_S = 3\text{V}$		580	1200	mV
I_{SC}	Short-Circuit Current	$V_S = 5\text{V}$	± 17	± 36		mA
		$V_S = 3\text{V}$	± 12	± 24		mA
I_S	Supply Current per Amplifier			4.95	6.2	mA
GBW	Gain-Bandwidth Product (Note 7)	$f = 100\text{kHz}$	20	40		MHz
SR	Slew Rate (Note 8)	$V_S = 5\text{V}$, $A_V = -1$, $R_L = \text{Open}$, $V_O = 4\text{V}$	11	22		V/ μs
		$V_S = 3\text{V}$, $A_V = -1$, $R_L = \text{Open}$	9	18		V/ μs

$T_A = 25^{\circ}\text{C}$, $V_S = \pm 15\text{V}$, $V_{CM} = 0\text{V}$, $V_{OUT} = 0\text{V}$, unless otherwise noted.

SYMBOL	PARAMETER	CONDITIONS	MIN	TYP	MAX	UNITS
V_{OS}	Input Offset Voltage	$V_{CM} = V^+$		500	2200	μV
		$V_{CM} = V^-$		500	2200	μV
ΔV_{OS}	Input Offset Voltage Shift	$V_{CM} = V^- \text{ to } V^+$		360	2200	μV
	Input Offset Voltage Match (Channel-to-Channel)	$V_{CM} = V^-, V^+$ (Note 5)		700	3500	μV
I_B	Input Bias Current	$V_{CM} = V^+$	0	1.15	2.2	μA
		$V_{CM} = V^-$	-2.2	-1.15	0	μA
ΔI_B	Input Bias Current Shift	$V_{CM} = V^- \text{ to } V^+$		2.3	4.4	μA
	Input Bias Current Match (Channel-to-Channel)	$V_{CM} = V^+$ (Note 5) $V_{CM} = V^-$ (Note 5)		50	880	nA
I_{OS}	Input Offset Current	$V_{CM} = V^+$		50	440	nA
		$V_{CM} = V^-$		50	440	nA
ΔI_{OS}	Input Offset Current Shift	$V_{CM} = V^- \text{ to } V^+$		36	880	nA
	Input Noise Voltage	0.1Hz to 10Hz		400		nV _{p-p}
e_n	Input Noise Voltage Density	$f = 1\text{kHz}$		12		nV/ $\sqrt{\text{Hz}}$
i_n	Input Noise Current Density	$f = 1\text{kHz}$		1.6		pA/ $\sqrt{\text{Hz}}$
C_{IN}	Input Capacitance	$f = 100\text{kHz}$		3		pF
A_{VOL}	Large-Signal Voltage Gain	$V_O = -14.5\text{V to } 14.5\text{V}$, $R_L = 10\text{k}$	800	5000		V/mV
		$V_O = -10\text{V to } 10\text{V}$, $R_L = 2\text{k}$	400	2500		V/mV
	Channel Separation	$V_O = -10\text{V to } 10\text{V}$, $R_L = 2\text{k}$	110	127		dB
CMRR	Common Mode Rejection Ratio	$V_{CM} = V^- \text{ to } V^+$	82	98		dB
	CMRR Match (Channel-to-Channel) (Note 5)	$V_{CM} = V^- \text{ to } V^+$	80	101		dB
PSRR	Power Supply Rejection Ratio	$V_S = \pm 5\text{V to } \pm 15\text{V}$	82	96		dB
	PSRR Match (Channel-to-Channel) (Note 5)	$V_S = \pm 5\text{V to } \pm 15\text{V}$	80	101		dB
V_{OL}	Output Voltage Swing Low (Note 6)	No Load		16	35	mV
		$I_{SINK} = 5\text{mA}$		150	300	mV
		$I_{SINK} = 25\text{mA}$		600	1200	mV
V_{OH}	Output Voltage Swing High (Note 6)	No Load		16	40	mV
		$I_{SOURCE} = 5\text{mA}$		250	500	mV
		$I_{SOURCE} = 25\text{mA}$		1200	2400	mV

ELECTRICAL CHARACTERISTICS

$T_A = 25^\circ\text{C}$, $V_S = \pm 15\text{V}$, $V_{CM} = 0\text{V}$, $V_{OUT} = 0\text{V}$, unless otherwise noted.

SYMBOL	PARAMETER	CONDITIONS	MIN	TYP	MAX	UNITS
I_{SC}	Short-Circuit Current		± 35	± 70		mA
I_S	Supply Current per Amplifier			4.6	6	mA
GBW	Gain-Bandwidth Product (Note 7)	$f = 100\text{kHz}$	22	45		MHz
SR	Slew Rate	$A_V = -1$, $R_L = \text{Open}$, $V_O = \pm 10\text{V}$, Measure at $V_O = \pm 5\text{V}$	22	45		V/ μs
t_S	Settling Time	0.01%, $V_{STEP} = 10\text{V}$, $A_V = 1$, $R_L = 1\text{k}$		575		ns

$0^\circ\text{C} < T_A < 70^\circ\text{C}$, $V_S = \pm 15\text{V}$, $V_{CM} = 0\text{V}$, $V_{OUT} = 0\text{V}$, unless otherwise noted.

SYMBOL	PARAMETER	CONDITIONS	MIN	TYP	MAX	UNITS
V_{OS}	Input Offset Voltage	$V_{CM} = V^+ - 0.1\text{V}$		800	2750	μV
		$V_{CM} = V^- + 0.2\text{V}$		800	2750	μV
$V_{OS\ TC}$	Input Offset Voltage Drift (Note 3)	$V_{CM} = V^+ - 0.1\text{V}$		10	17	$\mu\text{V}/^\circ\text{C}$
				5	11	$\mu\text{V}/^\circ\text{C}$
ΔV_{OS}	Input Offset Voltage Shift	$V_{CM} = V^- + 0.2\text{V}$ to $V^+ - 0.1\text{V}$		500	2500	μV
	Input Offset Voltage Match (Channel-to-Channel)	$V_{CM} = V^- + 0.2\text{V}$, $V^+ - 0.1\text{V}$ (Note 5)		800	4000	μV
I_B	Input Bias Current	$V_{CM} = V^+ - 0.1\text{V}$	0	1.3	2.6	μA
		$V_{CM} = V^- + 0.2\text{V}$	-2.6	-1.3	0	μA
ΔI_B	Input Bias Current Shift	$V_{CM} = V^- + 0.2\text{V}$ to $V^+ - 0.1\text{V}$		2.6	5.2	μA
	Input Bias Current Match (Channel-to-Channel)	$V_{CM} = V^+ - 0.1\text{V}$ (Note 5) $V_{CM} = V^- + 0.2\text{V}$ (Note 5)		70	1040	nA
I_{OS}	Input Offset Current	$V_{CM} = V^+ - 0.1\text{V}$		70	520	nA
		$V_{CM} = V^- + 0.2\text{V}$		70	520	nA
ΔI_{OS}	Input Offset Current Shift	$V_{CM} = V^- + 0.2\text{V}$ to $V^+ - 0.1\text{V}$		140	1040	nA
A_{VOL}	Large-Signal Voltage Gain	$V_O = -14.5\text{V}$ to 14.5V , $R_L = 10\text{k}$	600	4000		V/mV
		$V_O = -10\text{V}$ to 10V , $R_L = 2\text{k}$	300	2000		V/mV
	Channel Separation	$V_O = -10\text{V}$ to 10V , $R_L = 2\text{k}$	110	125		dB
CMRR	Common Mode Rejection Ratio	$V_{CM} = V^- + 0.2\text{V}$ to $V^+ - 0.1\text{V}$	81	96		dB
	CMRR Match (Channel-to-Channel) (Note 5)	$V_{CM} = V^- + 0.2\text{V}$ to $V^+ - 0.1\text{V}$	77	95		dB
PSRR	Power Supply Rejection Ratio	$V_S = \pm 5\text{V}$ to $\pm 15\text{V}$	80	94		dB
	PSRR Match (Channel-to-Channel) (Note 5)	$V_S = \pm 5\text{V}$ to $\pm 15\text{V}$	74	95		dB
V_{OL}	Output Voltage Swing Low (Note 6)	No Load		21	45	mV
		$I_{SINK} = 5\text{mA}$		180	350	mV
		$I_{SINK} = 25\text{mA}$		680	1400	mV
V_{OH}	Output Voltage Swing High (Note 6)	No Load		15	40	mV
		$I_{SOURCE} = 5\text{mA}$		300	600	mV
		$I_{SOURCE} = 25\text{mA}$		1400	2800	mV
I_{SC}	Short-Circuit Current		± 28	± 57		mA
I_S	Supply Current per Amplifier			5.2	6.9	mA
GBW	Gain-Bandwidth Product (Note 7)	$f = 100\text{kHz}$	20	41		MHz
SR	Slew Rate	$A_V = -1$, $R_L = \text{Open}$, $V_O = \pm 10\text{V}$, Measured at $V_O = \pm 5\text{V}$	21	43		V/ μs

ELECTRICAL CHARACTERISTICS

–40°C < T_A < 85°C, V_S = ±15V, V_{CM} = 0V, V_{OUT} = 0V, unless otherwise noted. (Note 4)

SYMBOL	PARAMETER	CONDITIONS	MIN	TYP	MAX	UNITS	
V _{OS}	Input Offset Voltage	V _{CM} = V ⁺ – 0.1V	●	1000	3000	μV	
		V _{CM} = V [–] + 0.2V	●	1000	3000	μV	
V _{OS} TC	Input Offset Voltage Drift (Note 3)	V _{CM} = V ⁺ – 0.1V	●	10	17	μV/°C	
			●	5	11	μV/°C	
ΔV _{OS}	Input Offset Voltage Shift	V _{CM} = V [–] + 0.2V to V ⁺ – 0.1V	●	500	2600	μV	
	Input Offset Voltage Match (Channel-to-Channel)	V _{CM} = V [–] + 0.2V, V ⁺ – 0.1V (Note 5)	●	850	4000	μV	
I _B	Input Bias Current	V _{CM} = V ⁺ – 0.1V	●	0	1.4	2.8	μA
		V _{CM} = V [–] + 0.2V	●	–2.8	–1.4	0	μA
ΔI _B	Input Bias Current Shift	V _{CM} = V [–] + 0.2V to V ⁺ – 0.1V	●	2.8	5.6	μA	
	Input Bias Current Match (Channel-to-Channel)	V _{CM} = V ⁺ – 0.1V (Note 5) V _{CM} = V [–] + 0.2V (Note 5)	● ●	75 75	1120 1120	nA nA	
I _{OS}	Input Offset Current	V _{CM} = V ⁺ – 0.1V	●	60	560	nA	
		V _{CM} = V [–] + 0.2V	●	60	560	nA	
ΔI _{OS}	Input Offset Current Shift	V _{CM} = V [–] + 0.2V to V ⁺ – 0.1V	●	120	1120	nA	
A _{VOL}	Large-Signal Voltage Gain	V _O = –14.5V to 14.5V, R _L = 10k V _O = –10V to 10V, R _L = 2k	● ●	500 250	5000 1800	V/mV V/mV	
	Channel Separation	V _O = –10V to 10V, R _L = 2k	●	110	124	dB	
CMRR	Common Mode Rejection Ratio	V _{CM} = V [–] + 0.2V to V ⁺ – 0.1V	●	81	96	dB	
	CMRR Match (Channel-to-Channel) (Note 5)	V _{CM} = V [–] + 0.2V to V ⁺ – 0.1V	●	77	95	dB	
PSRR	Power Supply Rejection Ratio	V _S = ±5V to ±15V	●	80	93	dB	
	PSRR Match (Channel-to-Channel) (Note 5)	V _S = ±5V to ±15V	●	74	95	dB	
V _{OL}	Output Voltage Swing Low (Note 6)	No Load	●	23	50	mV	
		I _{SINK} = 5mA	●	187	350	mV	
		I _{SINK} = 25mA	●	700	1400	mV	
V _{OH}	Output Voltage Swing High (Note 6)	No Load	●	16	40	mV	
		I _{SOURCE} = 5mA	●	300	600	mV	
		I _{SOURCE} = 25mA	●	1500	3000	mV	
I _{SC}	Short-Circuit Current		●	±27	±54	mA	
I _S	Supply Current per Amplifier		●	5.3	7	mA	
GBW	Gain-Bandwidth Product (Note 7)	f = 100kHz	●	20	40	MHz	
SR	Slew Rate	A _V = –1, R _L = Open, V _O = ±10V, Measure at V _O = ±5V	●	18	35	V/μs	

The ● denotes specifications that apply over the full operating temperature range.

Note 1: Absolute Maximum Ratings are those values beyond which the life of a device may be impaired.

Note 2: A heat sink may be required to keep the junction temperature below the absolute maximum rating when the output is shorted indefinitely.

Note 3: This parameter is not 100% tested.

Note 4: The LT1632C/LT1633C are guaranteed to meet specified performance from 0°C to 70°C and are designed, characterized and expected to meet these extended temperature limits, but are not tested at –40°C and 85°C. Guaranteed I grade parts are available, consult factory.

Note 5: Matching parameters are the difference between amplifiers A and D and between B and C on the LT1633; between the two amplifiers on the LT1632.

Note 6: Output voltage swings are measured between the output and power supply rails.

Note 7: V_S = 3V, V_S = ±15V GBW limit guaranteed by correlation to 5V tests.

Note 8: V_S = 3V, V_S = 5V slew rate limit guaranteed by correlation to ±15V tests.

Note 9: Minimum supply voltage is guaranteed by testing the change of V_{OS} to be less than 250μV when the supply voltage is varied from 3V to 2.7V.

TYPICAL PERFORMANCE CHARACTERISTICS

V_{OS} Distribution, $V_{CM} = 0V$ (PNP Stage)

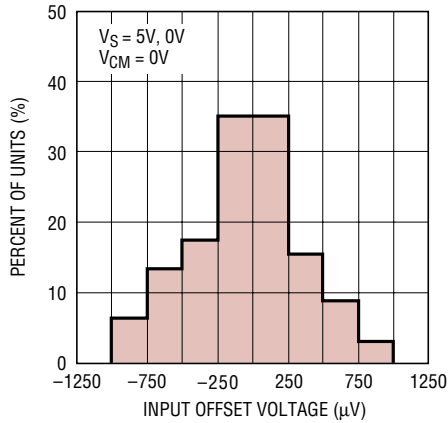

1632/33 G31

V_{OS} Distribution, $V_{CM} = 5V$ (NPN Stage)

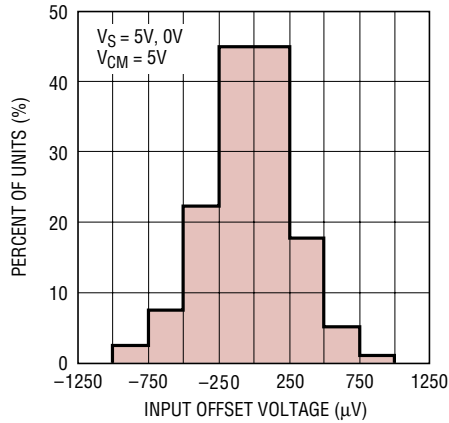

1632/33 G32

ΔV_{OS} Shift for $V_{CM} = 0V$ to $5V$

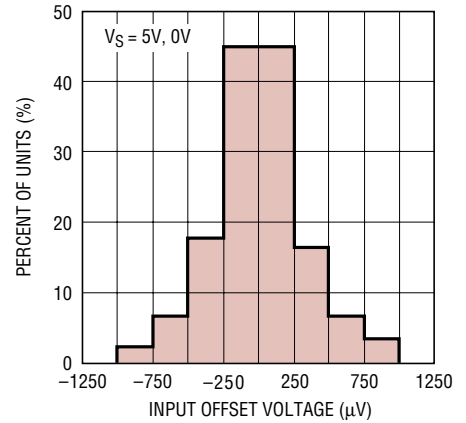

1632/33 G33

Supply Current vs Supply Voltage

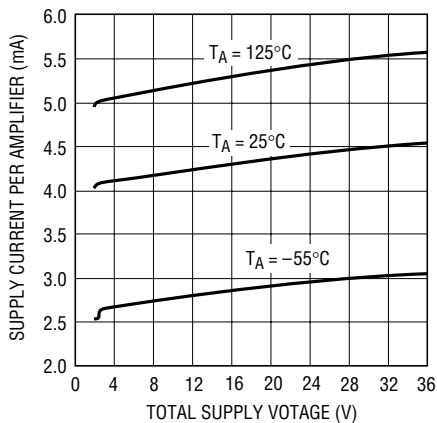

1630/31 G01

Supply Current vs Temperature

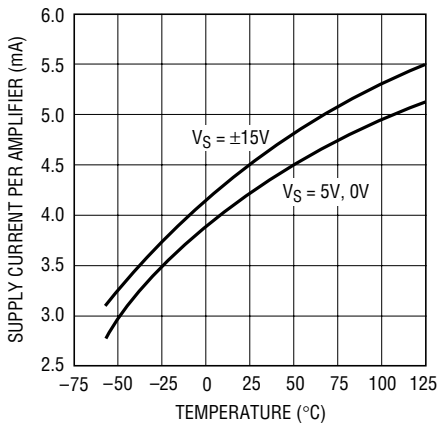

1632/33 G02

Input Bias Current vs Common Mode Voltage

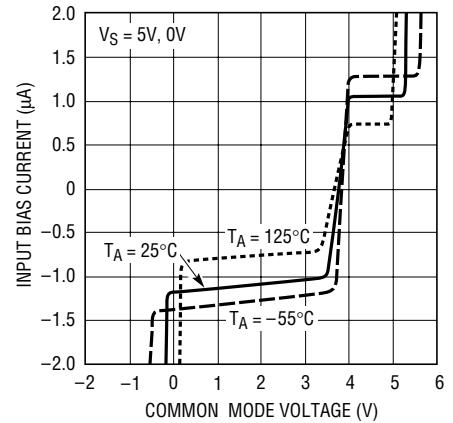

1632/33 G03

Input Bias Current vs Temperature

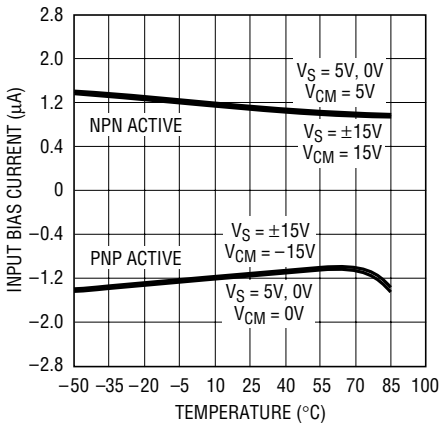

1632/33 G04

Output Saturation Voltage vs Load Current (Output Low)

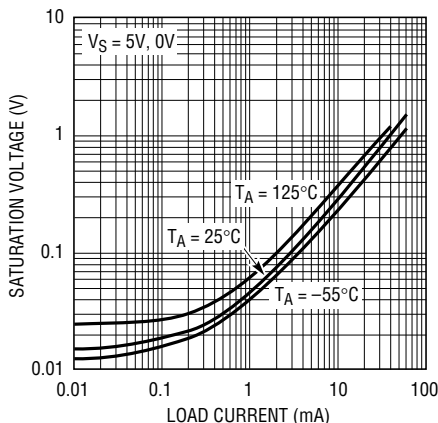

1632/33 G05

Output Saturation Voltage vs Load Current (Output High)

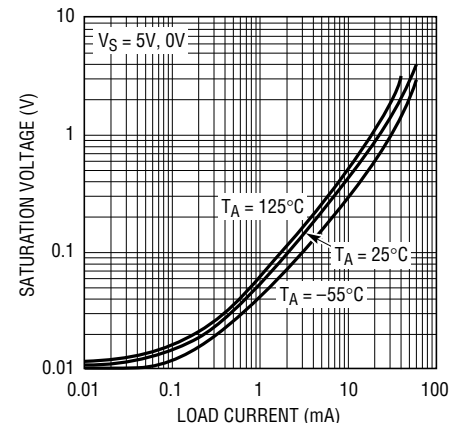

1632/33 G06

TYPICAL PERFORMANCE CHARACTERISTICS

Minimum Supply Voltage

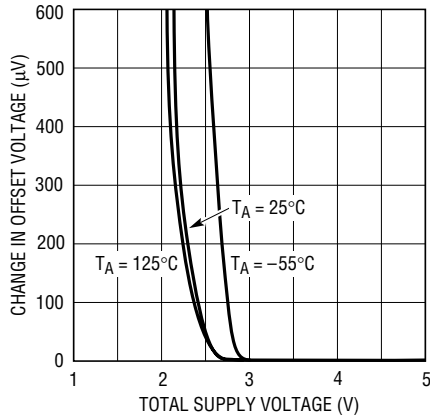

1632/33 G07

Noise Voltage Spectrum

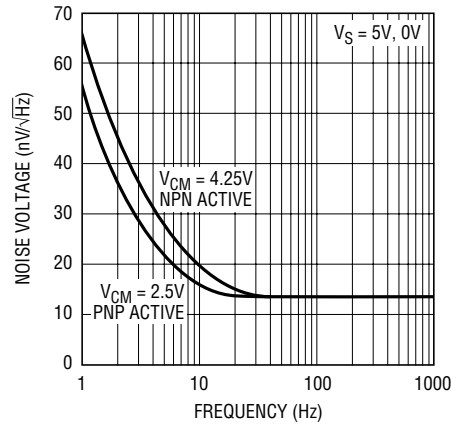

11632/33 G09

Noise Current Spectrum

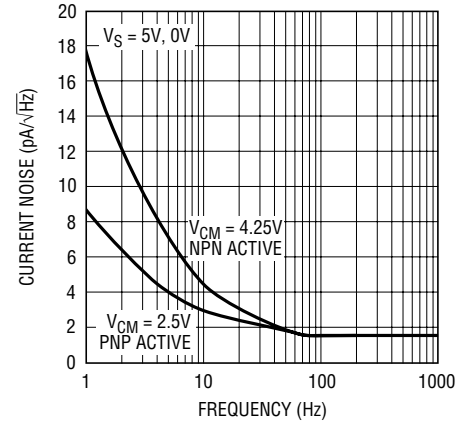

1632/33 G10

0.1Hz to 10Hz Output Voltage Noise

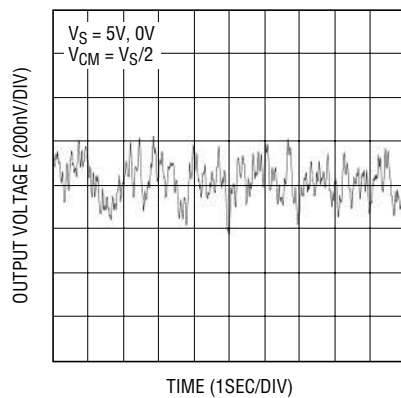

1632/33 G08

Gain and Phase vs Frequency

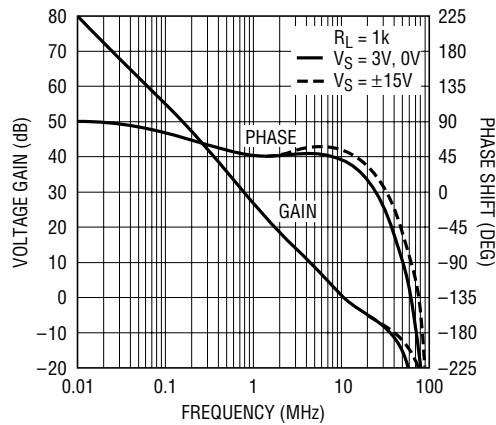

1632/33 G11

Gain Bandwidth and Phase Margin vs Supply Voltage

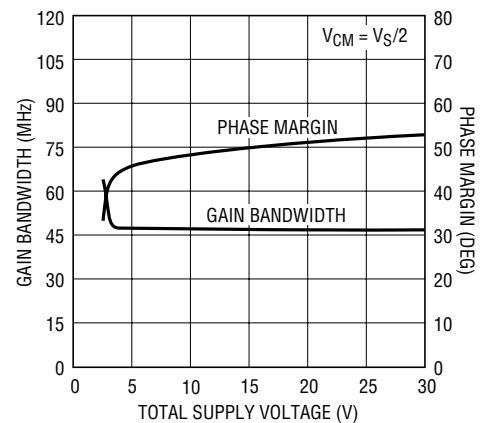

1632/33 G14

CMRR vs Frequency

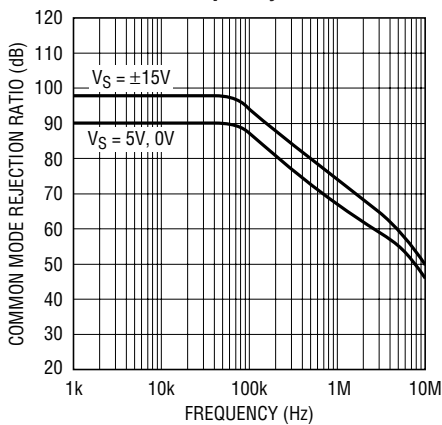

1632/33 G12

PSRR vs Frequency

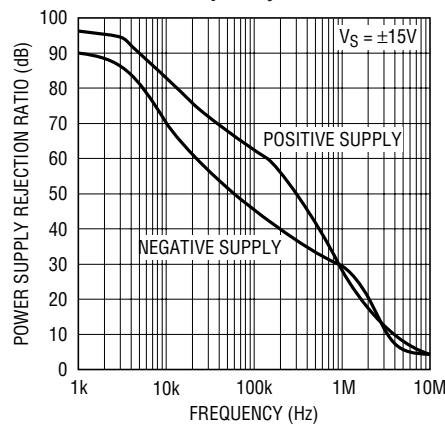

1632/33 G13

Channel Separation vs Frequency

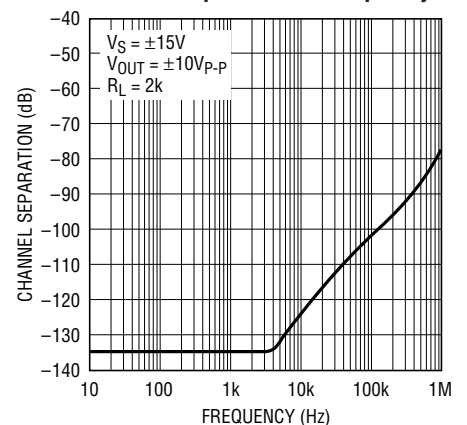

1632/33 G15

TYPICAL PERFORMANCE CHARACTERISTICS

Capacitive Load Handling

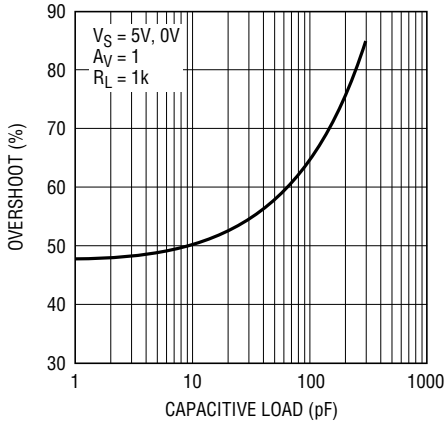

1632/33 G16

Slew Rate vs Supply Voltage

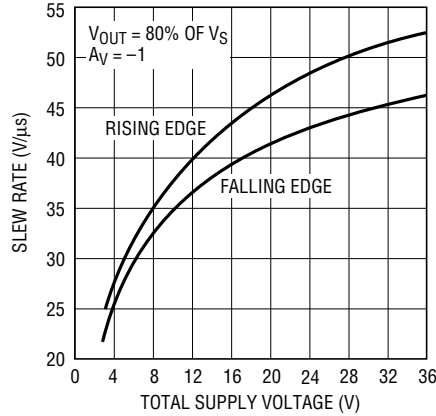

1632/33 G17

Output Step vs Settling Time to 0.01%

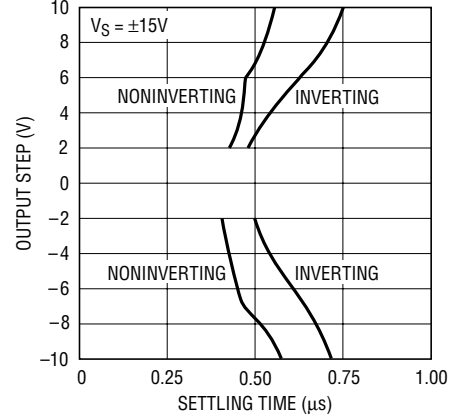

1632/33 G18

Open-Loop Gain

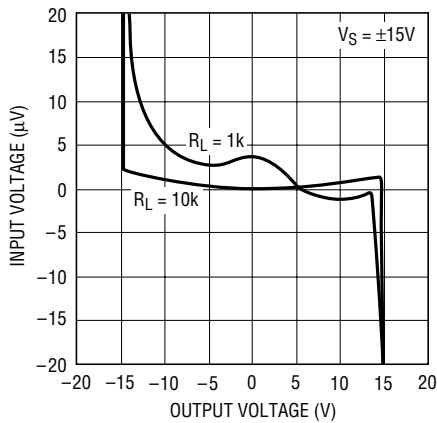

1632/33 G19

Open-Loop Gain

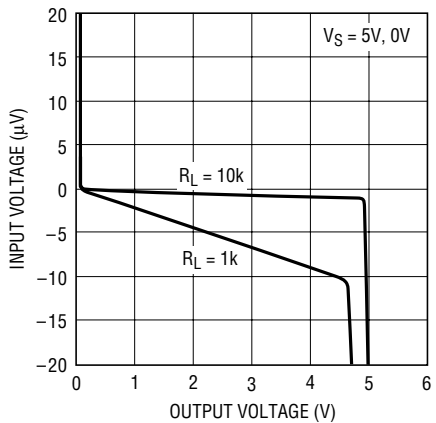

1632/33 G20

Open-Loop Gain

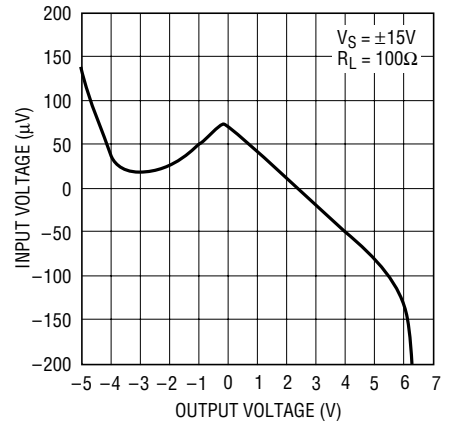

1632/33 G21

Warm-Up Drift vs Time

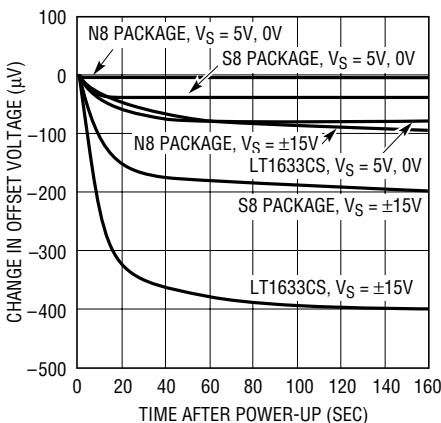

1632/33 G22

Maximum Undistorted Output Signal vs Frequency

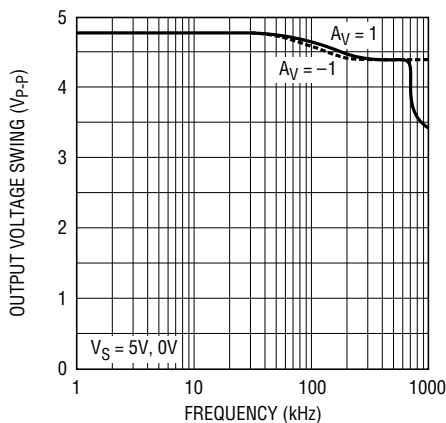

1630/31 G24

Total Harmonic Distortion + Noise vs Frequency

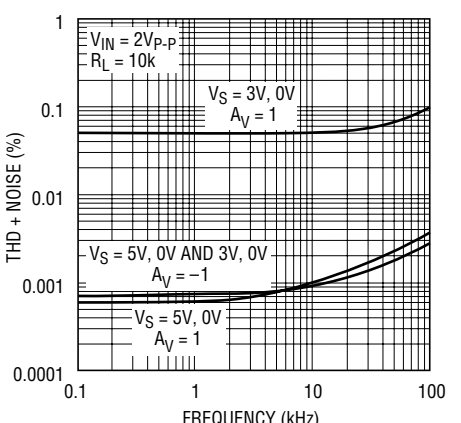

1632/33 G23

TYPICAL PERFORMANCE CHARACTERISTICS

Harmonic Distortion vs Frequency

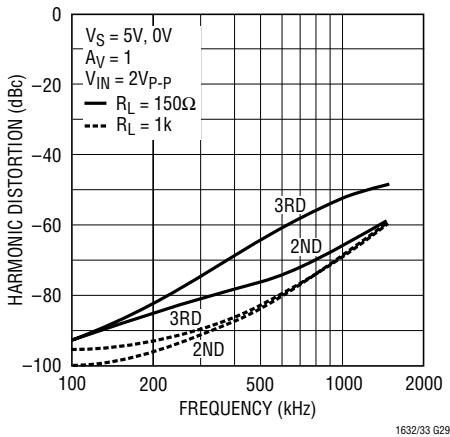

5V Small-Signal Response

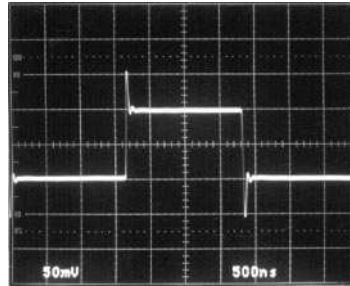

$V_S = 5V, 0V$
 $A_V = 1$
 $R_L = 1k$

1632/33 G25

5V Large-Signal Response

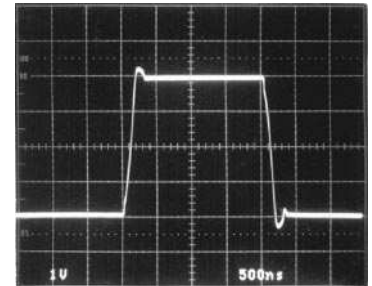

$V_S = 5V, 0V$
 $A_V = 1$
 $R_L = 1k$

1632/33 G26

Harmonic Distortion vs Frequency

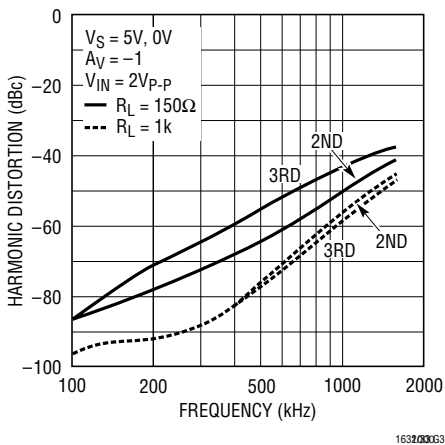

±15V Small-Signal Response

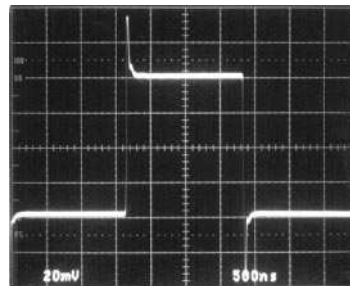

$V_S = \pm 15V$
 $A_V = 1$
 $R_L = 1k$

1632/33 G27

±15V Large-Signal Response

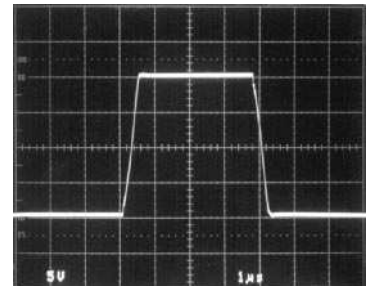

$V_S = \pm 15V$
 $A_V = 1$
 $R_L = 1k$

1632/33 G28

APPLICATIONS INFORMATION

Rail-to-Rail Input and Output

The LT1632/LT1633 are fully functional for an input and output signal range from the negative supply to the positive supply. Figure 1 shows a simplified schematic of the amplifier. The input stage consists of two differential amplifiers, a PNP stage Q1/Q2 and an NPN stage Q3/Q4 that are active over different ranges of input common mode voltage. The PNP differential input pair is active for input common mode voltages V_{CM} between the negative supply to approximately 1.5V below the positive supply. As V_{CM} moves closer toward the positive supply, the transistor Q5 will steer the tail current I_1 to the current mirror Q6/Q7, activating the NPN differential pair and the

PNP pair becomes inactive for the rest of the input common mode range up to the positive supply.

The output is configured with a pair of complementary common emitter stages Q14/Q15 that enables the output to swing from rail to rail. These devices are fabricated on Linear Technology's proprietary complementary bipolar process to ensure similar DC and AC characteristics. Capacitors C1 and C2 form local feedback loops that lower the output impedance at high frequencies.

Power Dissipation

The LT1632/LT1633 amplifiers combine high speed and large output current drive in a small package. Because the

sn1632 16323fs

APPLICATIONS INFORMATION

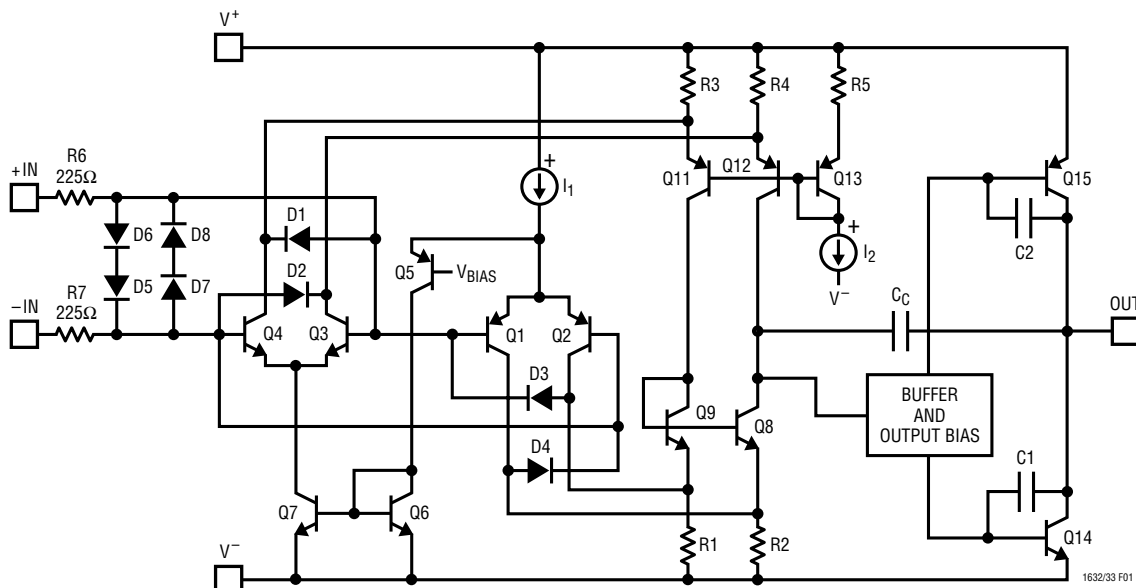

Figure 1. LT1632 Simplified Schematic Diagram

amplifiers operate over a very wide supply range, it is possible to exceed the maximum junction temperature of 150°C in plastic packages under certain conditions. Junction temperature T_J is calculated from the ambient temperature T_A and power dissipation P_D as follows:

$$\text{LT1632CN8: } T_J = T_A + (P_D \cdot 130^\circ\text{C/W})$$

$$\text{LT1632CS8: } T_J = T_A + (P_D \cdot 190^\circ\text{C/W})$$

$$\text{LT1633CS: } T_J = T_A + (P_D \cdot 150^\circ\text{C/W})$$

The power dissipation in the IC is the function of the supply voltage, output voltage and load resistance. For a given supply voltage, the worst-case power dissipation $P_{D\text{MAX}}$ occurs at the maximum supply current and when the output voltage is at half of either supply voltage (or the maximum swing if less than 1/2 supply voltage). Therefore $P_{D\text{MAX}}$ is given by:

$$P_{D\text{MAX}} = (V_S \cdot I_{S\text{MAX}}) + (V_S/2)^2/R_L$$

To ensure that the LT1632/LT1633 are used properly, calculate the worst-case power dissipation, use the thermal resistance for a chosen package and its maximum junction temperature to derive the maximum ambient temperature.

Example: An LT1632CS8 operating on $\pm 15\text{V}$ supplies and driving a 500Ω , the worst-case power dissipation per amplifier is given by:

$$P_{D\text{MAX}} = (30\text{V} \cdot 5.6\text{mA}) + (15\text{V} - 7.5\text{V})(7.5/500) = 0.168 + 0.113 = 0.281\text{W}$$

If both amplifiers are loaded simultaneously, then the total power dissipation is 0.562W . The SO-8 package has a junction-to-ambient thermal resistance of 190°C/W in still air. Therefore, the maximum ambient temperature that the part is allowed to operate is:

$$T_A = T_J - (P_{D\text{MAX}} \cdot 190^\circ\text{C/W})$$

$$T_A = 150^\circ\text{C} - (0.562\text{W} \cdot 190^\circ\text{C/W}) = 43^\circ\text{C}$$

For a higher operating temperature, lower the supply voltage or use the DIP package part.

Input Offset Voltage

The offset voltage changes depending upon which input stage is active, and the maximum offset voltages are trimmed to less than $1350\mu\text{V}$. To maintain the precision characteristics of the amplifier, the change of V_{OS} over the entire input common mode range (CMRR) is guaranteed to be less than $1500\mu\text{V}$ on a single 5V supply.

Input Bias Current

The input bias current polarity depends on the input common mode voltage. When the PNP differential pair is active, the input bias currents flow out of the input pins.

APPLICATIONS INFORMATION

They flow in the opposite direction when the NPN input stage is active. The offset voltage error due to input bias currents can be minimized by equalizing the noninverting and inverting input source impedance.

Output

The outputs of the LT1632/LT1633 can deliver large load currents; the short-circuit current limit is 70mA. Take care to keep the junction temperature of the IC below the absolute maximum rating of 150°C (refer to the Power Dissipation section). The output of these amplifiers have reverse-biased diodes to each supply. If the output is forced beyond either supply, unlimited current will flow through these diodes. If the current is transient and limited to several hundred mA, no damage to the part will occur.

Overdrive Protection

To prevent the output from reversing polarity when the input voltage exceeds the power supplies, two pairs of crossing diodes D1 to D4 are employed. When the input voltage exceeds either power supply by approximately 700mV, D1/D2 or D3/D4 will turn on, forcing the output to the proper polarity. For this phase reversal protection to work properly, the input current must be limited to less than 5mA. If the amplifier is to be severely overdriven, an external resistor should be used to limit the overdrive current.

The LT1632/LT1633's input stages are also protected against large differential input voltages by a pair of back-to-back diodes D5/D8. When a differential voltage of more than 1.4V is applied to the inputs, these diodes will turn on, preventing the emitter-base breakdown of the input transistors. The current in D5/D8 should be limited

to less than 10mA. Internal 225Ω resistors R6 and R7 will limit the input current for differential input signals of 4.5V or less. For larger input levels, a resistor in series with either or both inputs should be used to limit the current. Worst-case differential input voltage usually occurs when the output is shorted to ground. In addition, the amplifier is protected against ESD strikes up to 3kV on all pins.

Capacitive Load

The LT1632/LT1633 are wideband amplifiers that can drive capacitive loads up to 200pF on ±15V supplies in a unity-gain configuration. On a 3V supply, the capacitive load should be kept to less than 100pF. When there is a need to drive larger capacitive loads, a resistor of 20Ω to 50Ω should be connected between the output and the capacitive load. The feedback should still be taken from the output so that the resistor isolates the capacitive load to ensure stability.

Feedback Components

The low input bias currents of the LT1632/LT1633 make it possible to use the high value feedback resistors to set the gain. However, care must be taken to ensure that the pole formed by the feedback resistors and the total capacitance at the inverting input does not degrade stability. For instance, the LT1632/LT1633 in a noninverting gain of 2, set with two 20k resistors, will probably oscillate with 10pF total input capacitance (5pF input capacitance and 5pF board capacitance). The amplifier has a 6MHz crossing frequency and a 55° phase margin at 6dB of gain. The feedback resistors and the total input capacitance form a pole at 1.6MHz that induces a phase shift of 75° at 5MHz! The solution is simple: either lower the value of the resistors or add a feedback capacitor of 10pF or more.

TYPICAL APPLICATIONS

Single Supply, 40dB Gain, 550kHz Instrumentation Amplifier

An instrumentation amplifier with a rail-to-rail output swing, operating from a 3V supply can be constructed with the LT1632 as shown in the first page of this data sheet.

The amplifier has a nominal gain of 100, which can be adjusted with resistor R5. The DC output level is set by the difference of the two inputs multiplied by the gain of 100. The voltage gain and the DC output level can be expressed as follows:

TYPICAL APPLICATIONS

$$A_V = \frac{R_4}{R_3} \left(1 + \frac{R_2}{R_1} + \frac{R_3 + R_2}{R_5} \right)$$

$$V_{OUT} = \left(V_{IN}^+ - V_{IN}^- \right) \cdot A_V$$

Common mode range can be calculated by the following equations:

Lower limit common mode input voltage

$$V_{CML} = \left[\left(\frac{V_{OUT}}{A_V} \right) \frac{R_2}{R_5} + 0.1V \right] \frac{1.0}{1.1}$$

Upper limit common mode input voltage

$$V_{CMH} = \left[\left(\frac{V_{OUT}}{A_V} \right) \frac{R_2}{R_5} + (V_S - 0.15V) \right] \frac{1.0}{1.1}$$

where V_S is supply voltage.

For example, the common mode range is from 0.15V to 2.65V if the output is set at one half of the 3V supply. The common mode rejection is greater than 110dB at 100kHz when trimmed with resistor R1. The amplifier has a bandwidth of 550kHz.

Single Supply, 400kHz, 4th Order Butterworth Filter

The circuit shown in Figure 2 makes use of the low voltage operation and the wide bandwidth of the LT1632 to create a 400kHz 4th order lowpass filter with a single supply. The amplifiers are configured in the inverting mode to minimize common mode induced distortion and the output can swing rail-to-rail for the maximum dynamic range. Figure 3 displays the frequency response of the filter. Stopband attenuation is greater than 85dB at 10MHz.

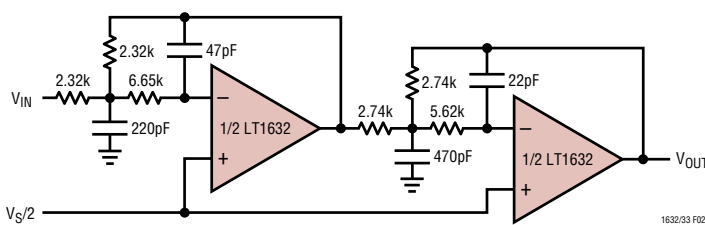

Figure 2. Single Supply, 400kHz, 4th Order Butterworth Filter

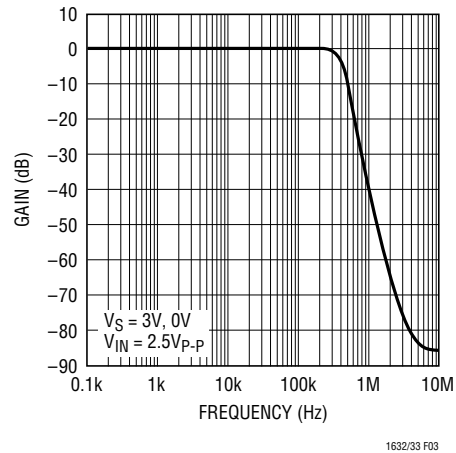

Figure 3. Frequency Response

With a 2.25V_{p-p}, 100kHz input signal on a 3V supply, the filter has harmonic distortion of less than -87dBc.

RF Amplifier Control Biasing and DC Restoration

Taking advantage of the rail-to-rail input and output, and the large output current capability of the LT1632, the circuit shown in Figure 4 provides precise bias current for the RF amplifiers and restores the DC output level. To ensure optimum performance of an RF amplifier, its bias point must be accurate and stable over the operating

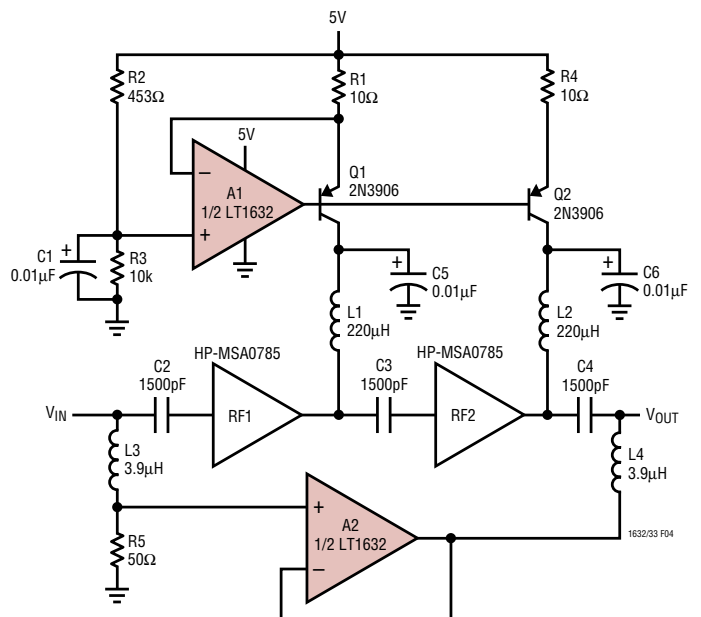

Figure 4. RF Amplifier Control Biasing and DC Restoration

sn1632 16323fs

TYPICAL APPLICATIONS

temperature range. The op amp A1 combined with Q1, Q2, R1, R2 and R3 establishes two current sources of 21.5mA to bias RF1 and RF2 amplifiers. The current of Q1, is determined by the voltage across R2 over R1, which is then replicated in Q2. These current sources are stable and precise over temperature and have a low dissipated power

due to a low voltage drop between their terminals. The amplifier A2 is used to restore the DC level at the output. With a large output current of the LT1632, the output can be set at 1.5V DC on 5V supply and 50Ω load. This circuit has a -3dB bandwidth from 2MHz to 2GHz and a power gain of 25dB.

PACKAGE DESCRIPTION Dimensions in inches (millimeters) unless otherwise noted.

N8 Package
8-Lead PDIP (Narrow 0.300)
 (LTC DWG # 05-08-1510)

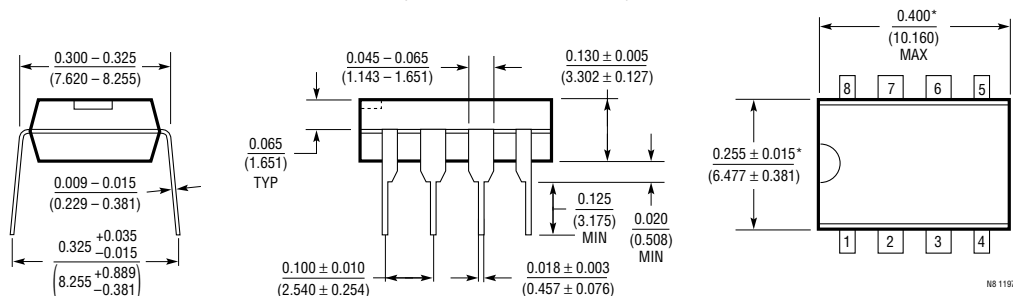

*THESE DIMENSIONS DO NOT INCLUDE MOLD FLASH OR PROTRUSIONS.
 MOLD FLASH OR PROTRUSIONS SHALL NOT EXCEED 0.010 INCH (0.254mm)

S8 Package
8-Lead Plastic Small Outline (Narrow 0.150)
 (LTC DWG # 05-08-1610)

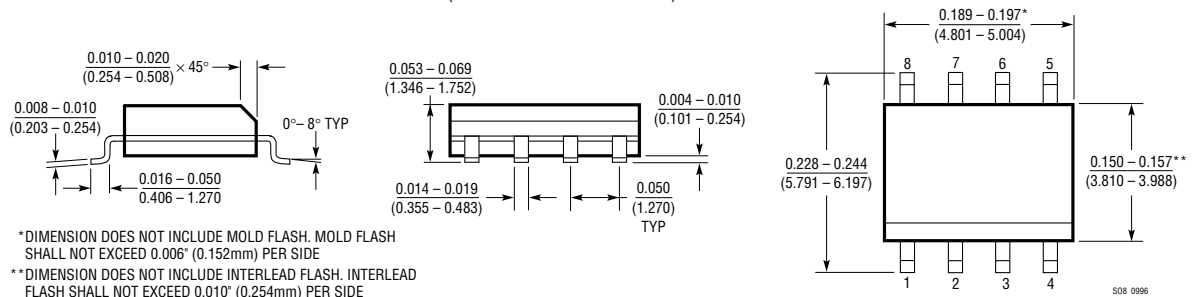

*DIMENSION DOES NOT INCLUDE MOLD FLASH. MOLD FLASH SHALL NOT EXCEED 0.006" (0.152mm) PER SIDE
 **DIMENSION DOES NOT INCLUDE INTERLEAD FLASH. INTERLEAD FLASH SHALL NOT EXCEED 0.010" (0.254mm) PER SIDE

S Package
14-Lead Plastic Small Outline (Narrow 0.150)
 (LTC DWG # 05-08-1610)

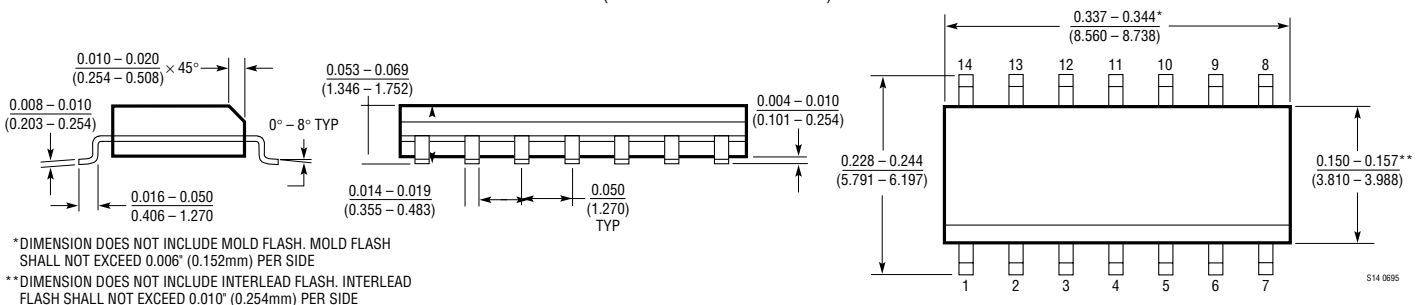

*DIMENSION DOES NOT INCLUDE MOLD FLASH. MOLD FLASH SHALL NOT EXCEED 0.006" (0.152mm) PER SIDE
 **DIMENSION DOES NOT INCLUDE INTERLEAD FLASH. INTERLEAD FLASH SHALL NOT EXCEED 0.010" (0.254mm) PER SIDE

sn1632 16323fs

TYPICAL APPLICATION

Tunable Q Notch Filter

A single supply, tunable Q notch filter as shown in Figure 5 is built with LT1632 to maximize the output swing. The filter has a gain of 2, and the notch frequency (f_0) is set by the values of R and C. The resistors R10 and R11 set up the DC level at the output. The Q factor can be adjusted by varying the value of R8. The higher value of R8 will

decrease Q as depicted in Figure 6, because the output induces less of feedback to amplifier A2. The value of R7 should be equal or greater than R9 to prevent oscillation. If R8 is a short and R9 is larger than R7, then the positive feedback from the output will create phase inversion at the output of amplifier A2, which will lead to oscillation.

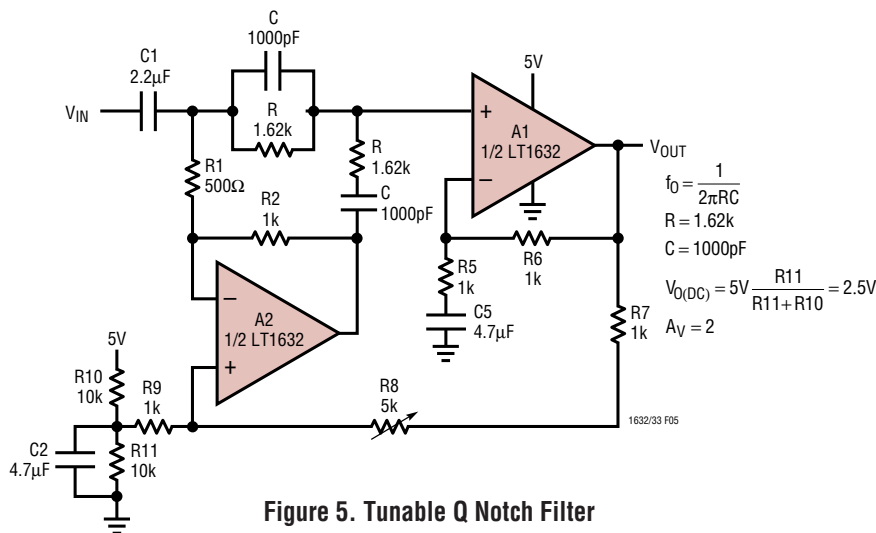

Figure 5. Tunable Q Notch Filter

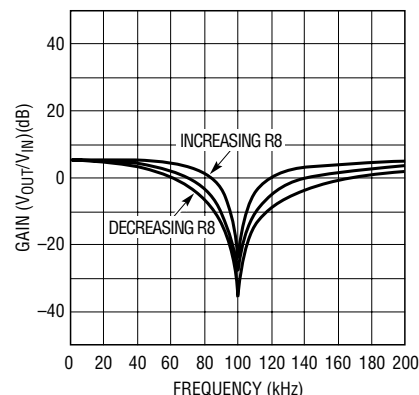

Figure 6. Frequency Response

RELATED PARTS

PART NUMBER	DESCRIPTION	COMMENTS
LT1211/LT1212	Dual/Quad 14MHz, 7V/µs, Single Supply Precision Op Amps	Input Common Mode Includes Ground, 275µV $V_{OS(MAX)}$, 6µV/°C Max Drift, Max Supply Current 1.8mA per Op Amp
LT1213/LT1214	Dual/Quad 28MHz, 12V/µs, Single Supply Precision Op Amps	Input Common Mode Includes Ground, 275µV $V_{OS(MAX)}$, 6µV/°C Max Drift, Max Supply Current 3.5mA per Op Amp
LT1215/LT1216	Dual/Quad 23MHz, 50V/µs, Single Supply Precision Op Amps	Input Common Mode Includes Ground, 450µV $V_{OS(MAX)}$, 6µV/°C Max Drift, Max Supply Current 6.6mA per Op Amp
LT1498/LT1499	Dual/Quad 10MHz, 6V/µs Rail-to-Rail Input and Output C-Load™ Op Amps	High DC Accuracy, 475µV $V_{OS(MAX)}$, 4µV/°C Max Drift, Max Supply Current 2.2mA per Amp
LT1630/LT1631	Dual/Quad 30MHz, 10V/µs Rail-to-Rail Input and Output Op Amps	High DC Accuracy, 525µV $V_{OS(MAX)}$, 70mA Output Current, Max Supply Current 4.4mA per Amp

C-Load is a trademark of Linear Technology Corporation.