

REV/	ECN. NO.	APP	DATE
A	EDIÇÃO INICIAL		

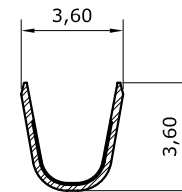

Section A-A

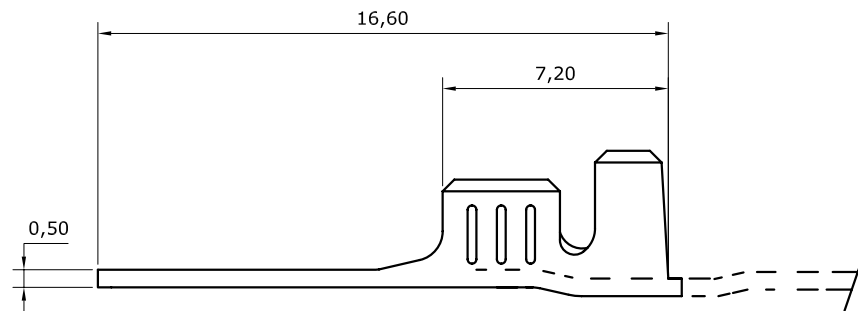
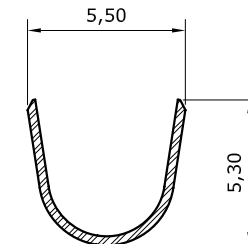

Section B-B

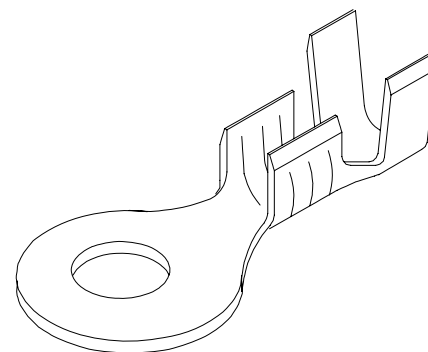
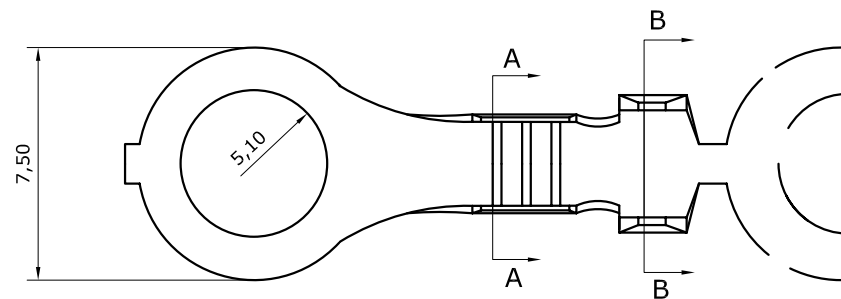

## HOW TO ORDER: 3775TO[00][01][02][R]

**1 2 3 4**

- 1- Acabamento:  
 (00)-Sem Banho  
 (01)-Com Banho Estanhado Fosco  
 (03)-Niquelado
- 2- Material:  
 (01)-Latão  
 (02)-Bonze Fosforoso

- 3- Fornecimento:  
 (01)-Granel  
 (02)-Fita
- 4-(R)RoHS Compliant

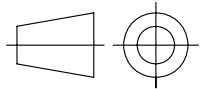
 <b>MATRIX TECNOLOGIA IND. E COM. LTDA.</b>			
UNIT mm	SCALE	TITLE terminal straight gauge 0.5 - 1.5mm <sup>2</sup>	DATE March 2009
TOLERANCE: ±0.25			APP. BY
		MATL	CHK. BY
		DWG. NO.	DR. BY Miller