

REV	ECN. NO.	APP	DATE
A	EDIÇÃO INICIAL		
B	NOVO CÓDIGO		

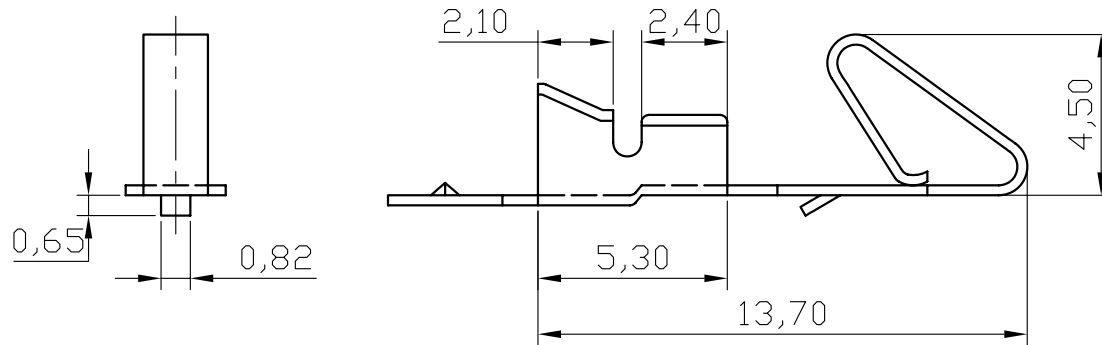

SPECIFICATION
Voltage Rating: 250V AC/DC
Current Rating: 5A AC/DC
Temperature Range: -25 ° C ~+85° C
Contact Resistance: 10 Milliohms Max.
Insulation Resistance: 1000 Megohms Min.
Dielectric Withstanding Voltage:
1500V AC/DC/Minute.

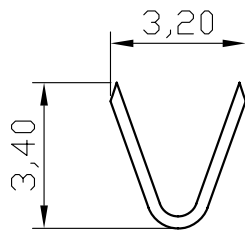

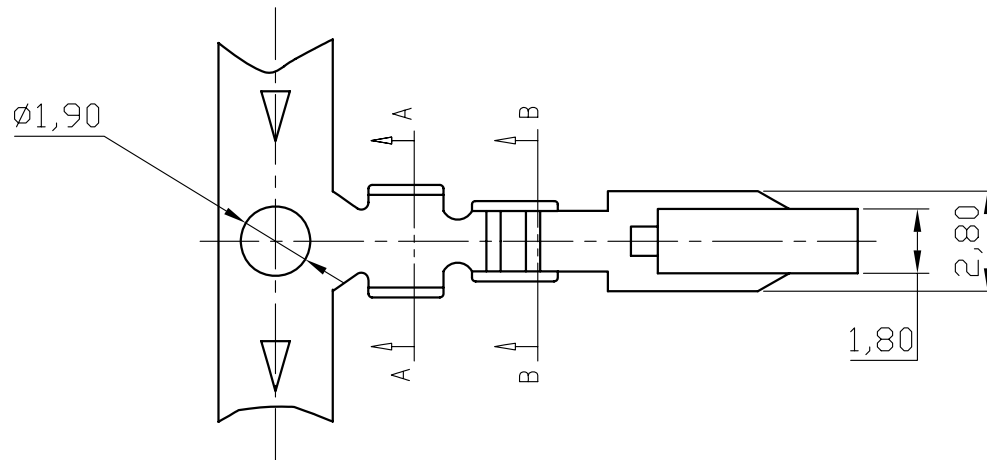

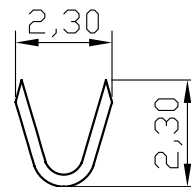
A-A SECTION



B-B SECTION

HOW TO ORDER:
5080T[][E]R
1 2

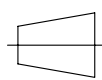
- 1- Terminal Plating
()-Tin
(D)-Gold Flash
(C)-Selective Gold
- 2- Wire Option
(B)-18 to 22 AWG
(E)-18 to 24 AWG

 MATRIX TECNOLOGIA IND. E COM. LTDA.			
UNIT	mm	SCALE	DATE MARCH 2010
TOLERANCE: ±0.25		TITLE	APP. BY
		5,08mm TERMINAL	
 		MATL	CHK. BY
		DWG. NO.	DR. BY FELIPE