

# Slotted Optical Switch

Series: OPB355, OPB360, OPB370, OPB380, OPB390

OPB859, OPB860, OPB870, OPB880, OPB890



## Features:

- 0.125" (3.175 mm) slot width
- Choice of aperture (0.050" or 0.010" width)
- Choice of opaque or IR transmissive shell material
- Choice of mounting configurations
- Choice of lead spacing or wires

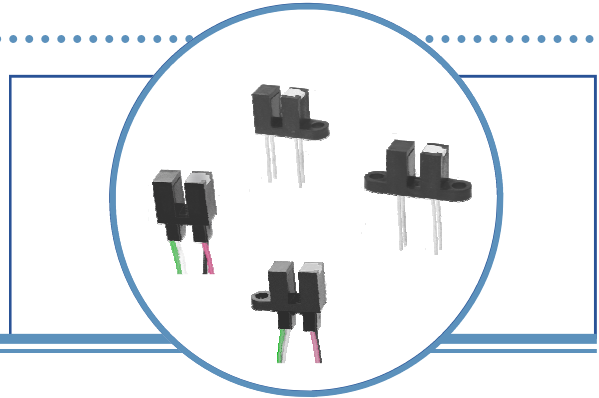

## Description:

The slotted optical sensors in this series provide the flexibility of a custom device from a standard product line.

Building from a standard housing with a 0.125" (3.18mm) wide slot, the user can specify output logic state, output driver circuit, aperture width, aperture surface and mounting tab locations. Furthermore, an option of wire or PCB leads allows electrical interface flexibility.

The device body is an opaque plastic which minimizes sensitivity to both visible and near-infrared external light sources which may impact operation. Aperture width choices provide different optical resolution for motion sensing. A covered aperture provides dust protection, while an open aperture provides maximum protection against external light sources.

Phototransistor sensor devices are: OPB360, OPB370, OPB380, OPB390, OPB859, OPB860, OPB870, OPB880, OPB890. The OPB355 provides a photodiode detector, which has a lower linear output-versus-light.

Wide electrical output current ranges are available. LED emissions are near-infrared (850-940nm).

Custom electrical, wire and cabling services are available.

Contact your local representative or OPTEK for more information. Compliant to EU RoHS Directive 2002/95/EC.

## Applications:

- Non-contact object sensing
- Assembly line automation
- Machine automation
- Equipment safety
- Machine safety

OPB355

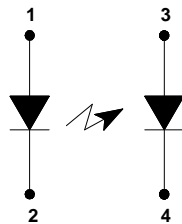

OPB360, OPB370, OPB380, OPB390  
OPB859

OPB860, OPB870, OPB880, OPB890

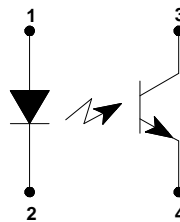

| Wire Colors |             |
|-------------|-------------|
| Color #     | Description |
| 1           | Red         |
| 2           | Black       |
| 3           | White       |
| 4           | Green       |



RoHS

### CONTAINS POLYSULFONE

To avoid stress cracking, we suggest using ND Industries' **Vibra-Tite** for thread-locking. **ND Vibra-Tite Formula 3** evaporates fast without causing structural failure in OPTEK's molded plastics.

**Applies to: OPB360, OPB370, OPB380, OPB390 and OPB860, OPB870, OPB880, OPB890.**

OPTEK reserves the right to make changes at any time in order to improve design and to supply the best product possible.

# Slotted Optical Switch

Series: OPB355, OPB360, OPB370, OPB380, OPB390

OPB859, OPB860, OPB870, OPB880, OPB890



## Part Number Guide — OPB355

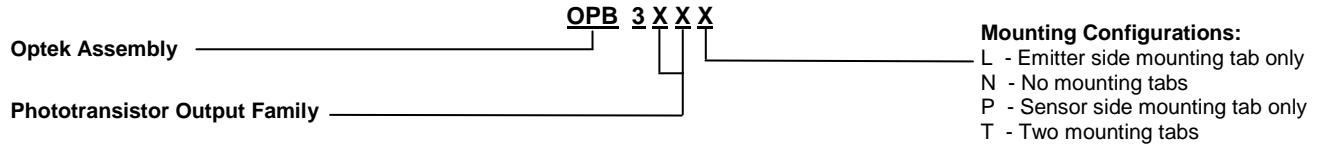

## Part Number Guide — OPB360 / OPB370

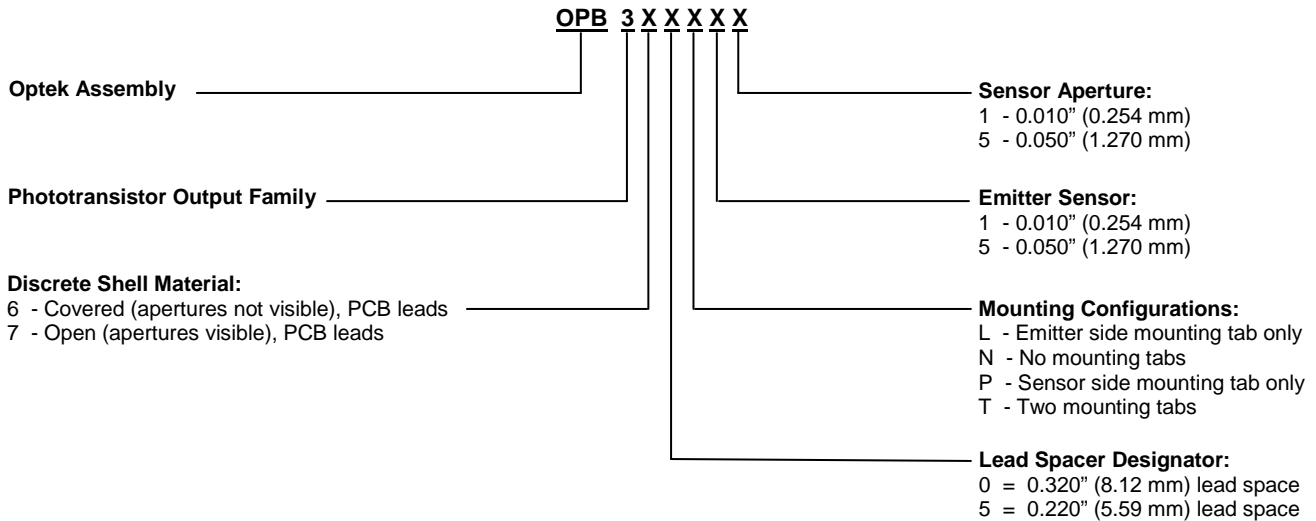

## Part Number Guide — OPB380 / OPB390

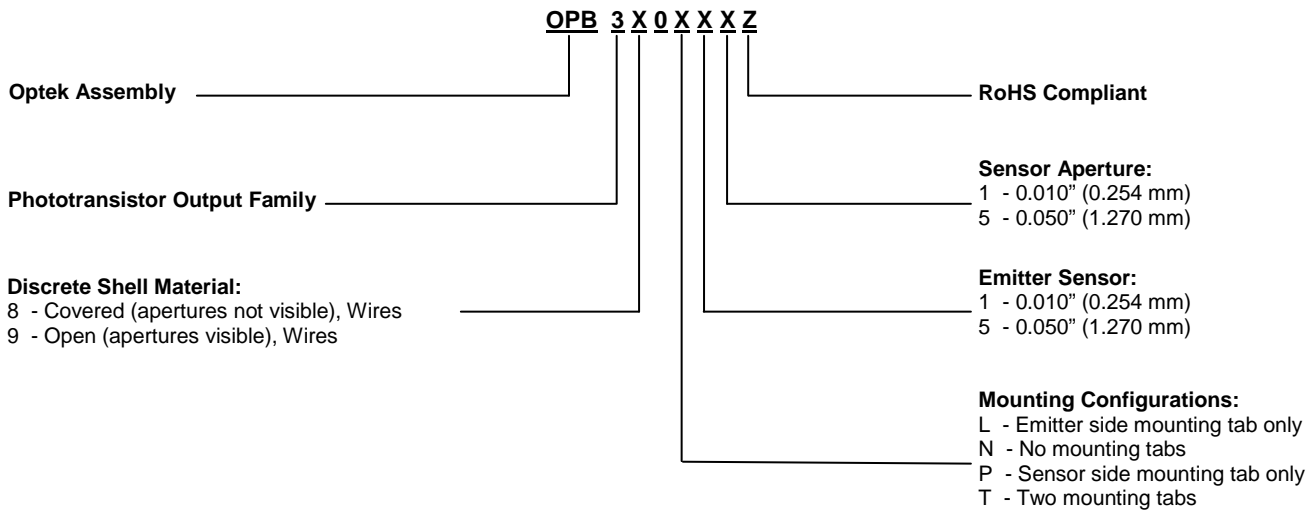

OPTEK reserves the right to make changes at any time in order to improve design and to supply the best product possible.

# Slotted Optical Switch

Series: OPB355, OPB360, OPB370, OPB380, OPB390

OPB859, OPB860, OPB870, OPB880, OPB890



## Part Number Guide — OPB859

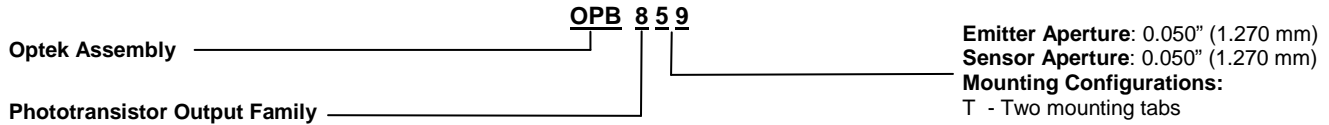

## Part Number Guide — OPB860 / OPB870

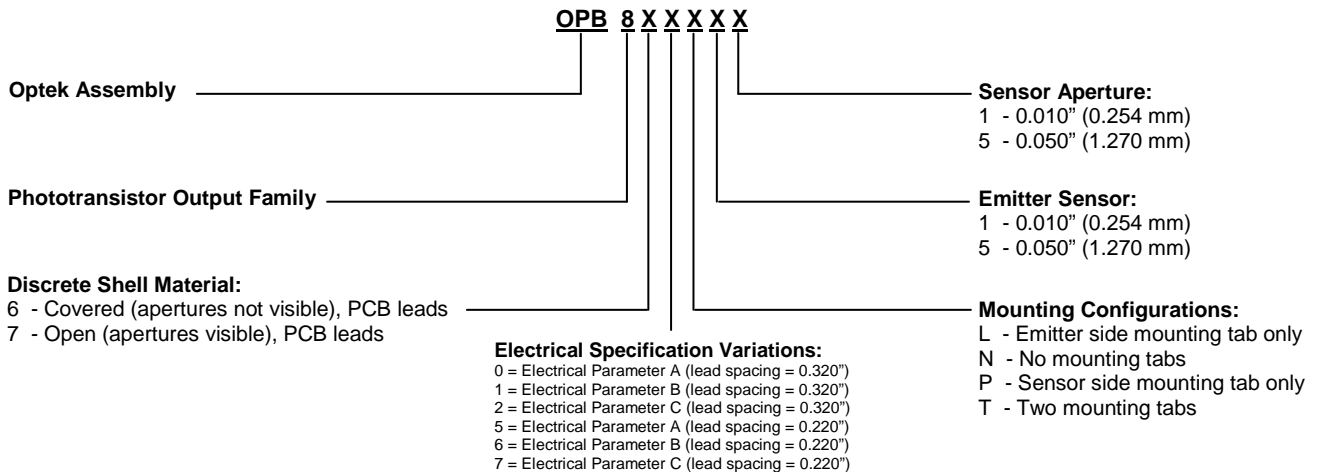

Note: Assemblies with dual 0.010" apertures are currently available with electrical parameter "A" only.

## Part Number Guide — OPB880 / OPB890

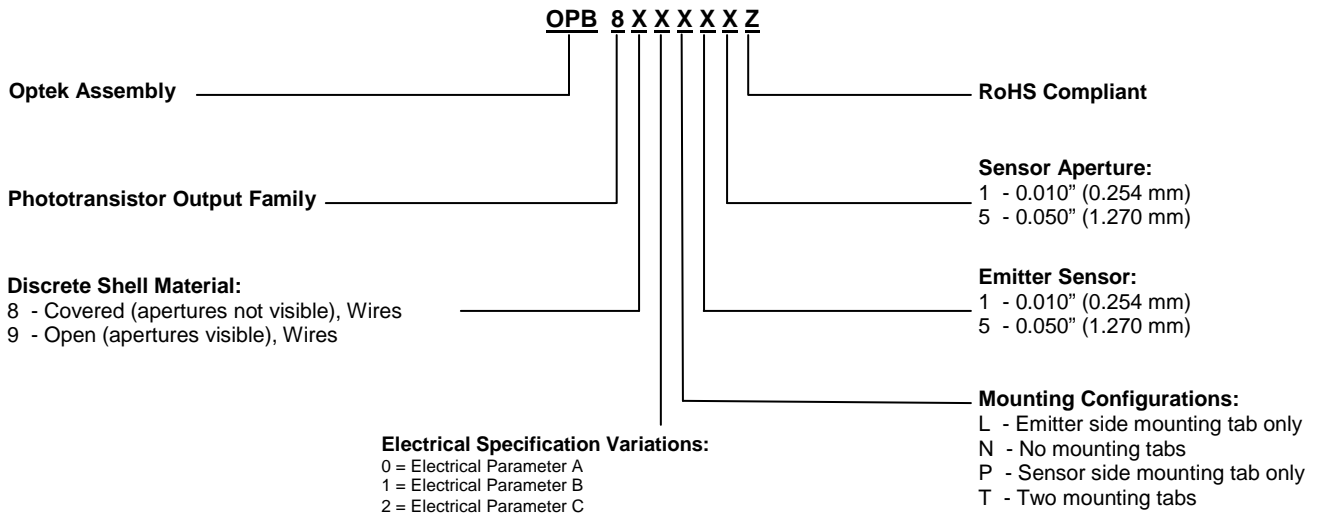

NOTE: Assemblies with dual 0.010" apertures are currently available with electrical parameter "A" only.  
Wires = 26AWG - 24" long. UL approved.

OPTEK reserves the right to make changes at any time in order to improve design and to supply the best product possible.

# Slotted Optical Switch

Series: OPB355, OPB360, OPB370, OPB380, OPB390  
 OPB859, OPB860, OPB870, OPB880, OPB890



## OPB355, OPB360, OPB370, OPB860, OPB870

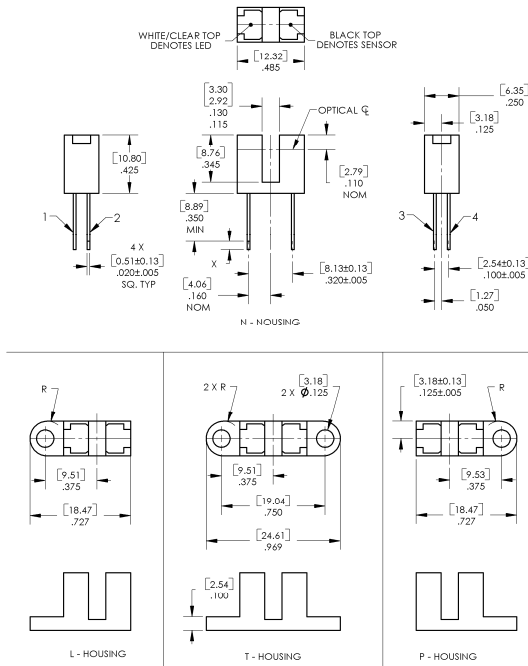

## OPB380, OPB390

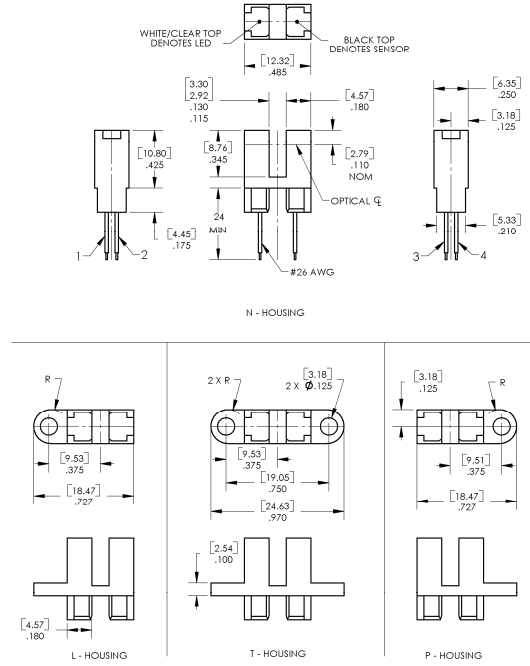

## OPB859

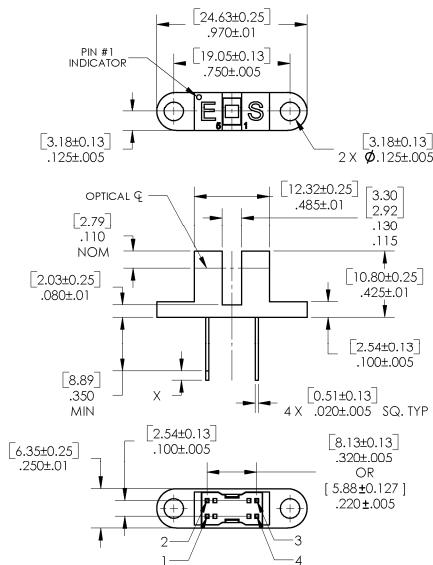

## OPB880, OPB890

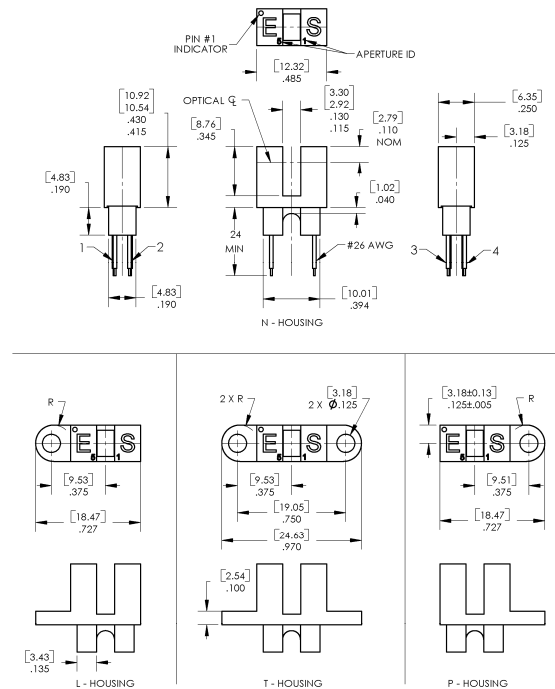

| Pin # | Emitter | Pin # | Transistor/Diode  |
|-------|---------|-------|-------------------|
| 1     | Anode   | 3     | Collector / Anode |
| 2     | Cathode | 4     | Emitter / Cathode |

DIMENSIONS ARE IN: [ MILLIMETERS ]  
 INCHES

OPTEK reserves the right to make changes at any time in order to improve design and to supply the best product possible.

# Slotted Optical Switch

Series: OPB355, OPB360, OPB370, OPB380, OPB390

OPB859, OPB860, OPB870, OPB880, OPB890



## Absolute Maximum Ratings ( $T_A=25^\circ\text{C}$ unless otherwise noted)

|  |                                   |
|--|-----------------------------------|
| Storage Temperature <sup>(1) (2)</sup><br>OPB355, OPB360, OPB370, OPB859, OPB860, OPB870 Series<br>OPB380, OPB390, OPB880, OPB890 Series | -40°C to +100°C<br>-40°C to +85°C |
| Operating Temperature <sup>(1) (2)</sup>   | -40°C to +85°C                    |
| Lead Soldering Temperature <sup>(7)</sup>  | 260°C                             |

## Input LED

|  |       |
|--|-------|
| Forward DC Current<br>OPB355, OPB360, OPB370, OPB380, OPB390, OPB859, OPB860, OPB870, OPB880, OPB890 | 50 mA |
| Peak Forward Current (1 $\mu\text{s}$ pulse width, 300 pps)  | 1 A   |
| Reverse DC Voltage   | 2 V   |
| Power Dissipation <sup>(2)</sup>   | 75 mW |

## Output Phototransistor/Diode

|  |        |
|--|--------|
| Cathode-Anode Reverse Voltage -OPB355  | 60 V   |
| Collector-Emitter Voltage<br>OPB360, OPB370, OPB380, OPB390, OPB859, OPB860, OPB870, OPB880, OPB890 Series | 30 V   |
| Emitter-Collector Voltage  | 5 V    |
| Collector DC Current   | 30 mA  |
| Power Dissipation <sup>(1)</sup>   | 100 mW |

### Notes:

- (1) For wire series (OPB380, OPB390, OPB880 and OPB890), maximum storage and operating temperature is limited by the temperature rating of the lead wires.
- (2) Derate linearly 1.67 mW/°C above 25°C.
- (3) For OPB355, OPB360 and OPB370, polarity is denoted by color of housing top: LED (clear); sensor (black).
- (4) Cleaning agents methanol and isopropanol are recommended. Spray or wipe; do not submerge.
- (5) OPB380 and OPB390 wire terminations have 24" of 7-strand 26 AWG UL approved insulated wire on each terminal. These devices incorporate a wire strain relief at the housing surface. The insulation colors and functions are: IRED anode (red); IRED cathode (black); phototransistor collector (white); phototransistor emitter (green).
- (6) RMA flux is recommended. Duration can be extended to 10 seconds maximum when flow soldering.
- (7) All parameters were tested using pulse technique.

OPTEK reserves the right to make changes at any time in order to improve design and to supply the best product possible.

# Slotted Optical Switch

Series: OPB355, OPB360, OPB370, OPB380, OPB390

OPB859, OPB860, OPB870, OPB880, OPB890



## Electrical Characteristics (T<sub>A</sub> = 25°C unless otherwise noted)

| SYMBOL | PARAMETER | MIN | TYP | MAX | UNITS | TEST CONDITIONS |
|--------|-----------|-----|-----|-----|-------|-----------------|
|--------|-----------|-----|-----|-----|-------|-----------------|

### Input Transistor/Diode (See OP240 for additional information—for reference only)

|                |                 |   |     |     |    |                        |
|----------------|-----------------|---|-----|-----|----|------------------------|
| V <sub>F</sub> | Forward Voltage | - | 1.3 | 1.8 | V  | I <sub>F</sub> = 20 mA |
| I <sub>R</sub> | Reverse Current | - | -   | 100 | μA | V <sub>R</sub> = 2 V   |

### Output Diode — OPB355 (See OPB950 for additional information — for reference only)

|                 |                                 |    |   |     |    |   |
|-----------------|---------------------------------|----|---|-----|----|---|
| V <sub>BR</sub> | Reverse Diode Breakdown Voltage | 60 | - | -   | V  | I <sub>R</sub> = 100 μA, I <sub>F</sub> = 0, E <sub>E</sub> = 0 |
| V <sub>FD</sub> | Forward Voltage Photodiode      | -  | - | 1.2 | V  | I <sub>F</sub> = 1 mA, I <sub>F</sub> = 0, E <sub>E</sub> = 0   |
| ID              | Reverse Dark Current            | -  | - | 60  | nA | V <sub>R</sub> = 30 V, E <sub>E</sub> = 0, I <sub>F</sub> = 0   |

### Output Transistor (See OP550 for additional information—for reference only)

|                      |                                     |    |   |     |    |  |
|----------------------|-------------------------------------|----|---|-----|----|--|
| V <sub>(BR)CEO</sub> | Collector-Emitter Breakdown Voltage | 30 | - | -   | V  | I <sub>C</sub> = 1 mA  |
| V <sub>(BR)ECO</sub> | Emitter-Collector Breakdown Voltage | 5  | - | -   | V  | I <sub>E</sub> = 100 μA  |
| I <sub>CEO</sub>     | Collector-Emitter Dark Current      | -  | - | 100 | nA | V <sub>CE</sub> = 10 V, I <sub>F</sub> = 0, E <sub>E</sub> = 0 |

### Coupled

|                      |   |  |                                 |   |    |   |
|----------------------|---|--|---------------------------------|---|----|---|
| I <sub>L</sub>       | On-State Collector Current<br>OPB355 (L, N, P, T)   | 10                                     | -                               | 200   | μA | V <sub>R</sub> = 5 V, I <sub>F</sub> = 40 mA  |
| V <sub>CE(SAT)</sub> | Collector-Emitter Saturation Voltage<br>OPB859<br>OPB860/870/865/875 (Para. A)<br>OPB861/871/866/876 (Para. B)<br>OPB862/872/867/877 (Para. C)<br>OPB880/890/ (Para. A)<br>OPB881/891 (Para. B)<br>OPB882/892 (Para. C)   | -<br>-<br>-<br>-<br>-<br>-<br>-        | -<br>-<br>-<br>-<br>-<br>-<br>- | 0.4<br>0.4<br>0.4<br>0.6<br>0.4<br>0.4<br>0.6 | V  | I <sub>C</sub> = 125 μA, I <sub>F</sub> = 20 mA<br>I <sub>C</sub> = 400 μA, I <sub>F</sub> = 20 mA<br>I <sub>C</sub> = 800 μA, I <sub>F</sub> = 20 mA<br>I <sub>C</sub> = 1800 μA, I <sub>F</sub> = 20 mA<br>I <sub>C</sub> = 400 μA, I <sub>F</sub> = 20 mA<br>I <sub>C</sub> = 800 μA, I <sub>F</sub> = 10 mA<br>I <sub>C</sub> = 1800 μA, I <sub>F</sub> = 20 mA |
| I <sub>C(ON)</sub>   | On-State Collector Current<br>OPB36X, OPB37X (T, N, L, P 11)<br>OPB36X, OPB37X (T, N, L, P 51)<br>OPB36X, OPB37X (T, N, L, P 55)<br>OPB38X, OPB39X (T, N, L, P 11)<br>OPB38X, OPB39X (T, N, L, P 51)<br>OPB38X, OPB39X (T, N, L, P 55)<br>OPB859<br>OPB860/870/865/875 (Para. A)<br>OPB861/871/866/876 (Para. B)<br>OPB862/872/867/877 (Para. C)<br>OPB880/890/ (Para. A)<br>OPB881/891 (Para. B)<br>OPB882/892 (Para. C) | 1.0<br>2.5<br>3.5<br>1.0<br>2.5<br>3.5 | -<br>-<br>-<br>-<br>-<br>-      | 5<br>10<br>14<br>5<br>10<br>14                | mA | V <sub>CE</sub> = 0.4 V, I <sub>F</sub> = 20 mA   |
|                      |   | 250                                    | -                               | -   | μA | V <sub>CE</sub> = 10 V, I <sub>F</sub> = 20 mA  |
|                      |   | 0.5<br>1.0<br>1.8<br>0.5<br>1.0<br>1.8 | -<br>-<br>-<br>-<br>-<br>-      | -<br>-<br>-<br>-<br>-<br>-                    | mA | V <sub>CE</sub> = 10 V, I <sub>F</sub> = 20 mA<br>V <sub>CE</sub> = 5 V, I <sub>F</sub> = 10 mA<br>V <sub>CE</sub> = 0.6 V, I <sub>F</sub> = 20 mA<br>V <sub>CE</sub> = 10 V, I <sub>F</sub> = 20 mA<br>V <sub>CE</sub> = 5 V, I <sub>F</sub> = 10 mA<br>V <sub>CE</sub> = 0.6 V, I <sub>F</sub> = 20 mA  |

OPTEK reserves the right to make changes at any time in order to improve design and to supply the best product possible.

# Slotted Optical Switch

Series: OPB355, OPB360, OPB370, OPB380, OPB390

OPB859, OPB860, OPB870, OPB880, OPB890



OPB355 - Flag Next to Emitter

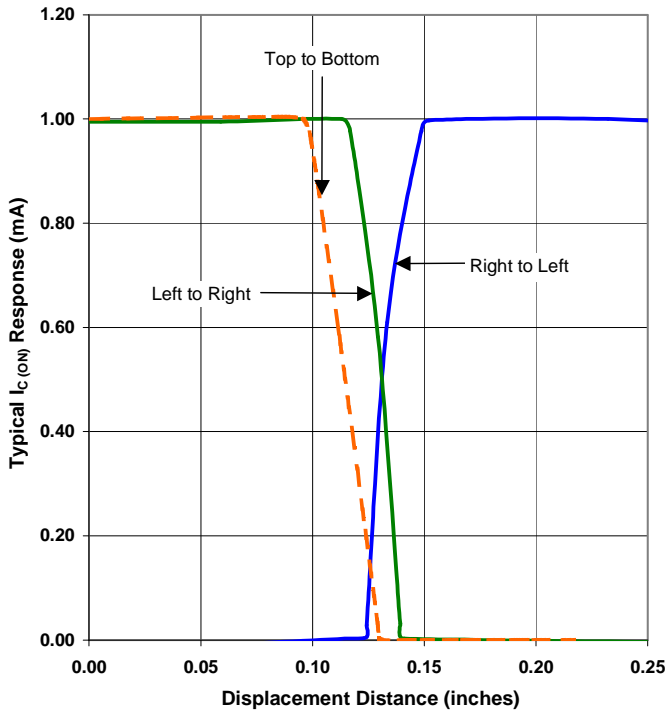

OPB355 - Flag Next to Sensor

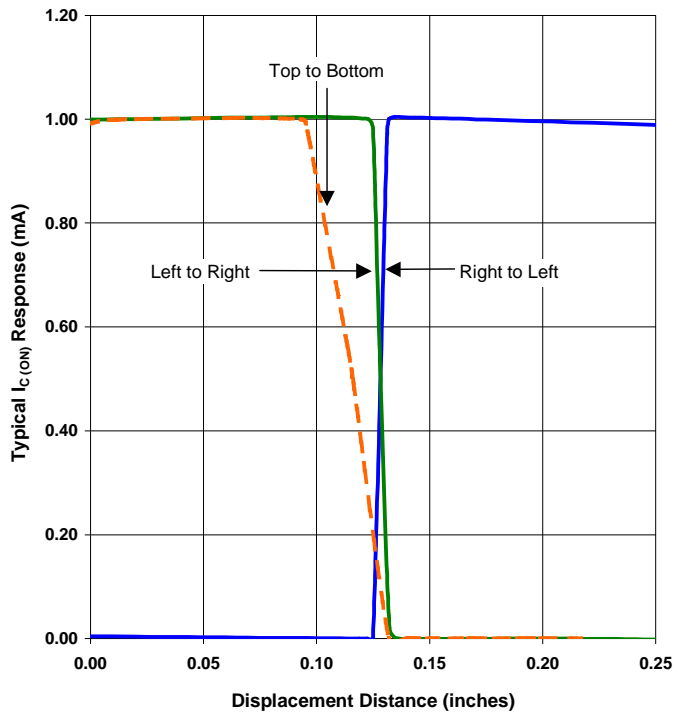

OPB355 - Flag in Middle of Slot

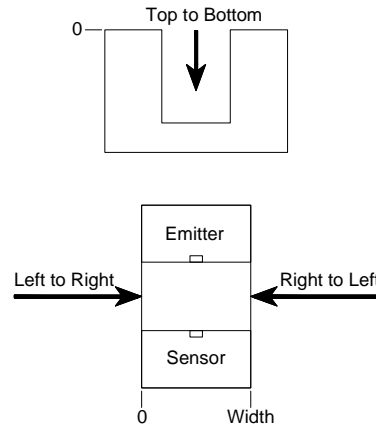
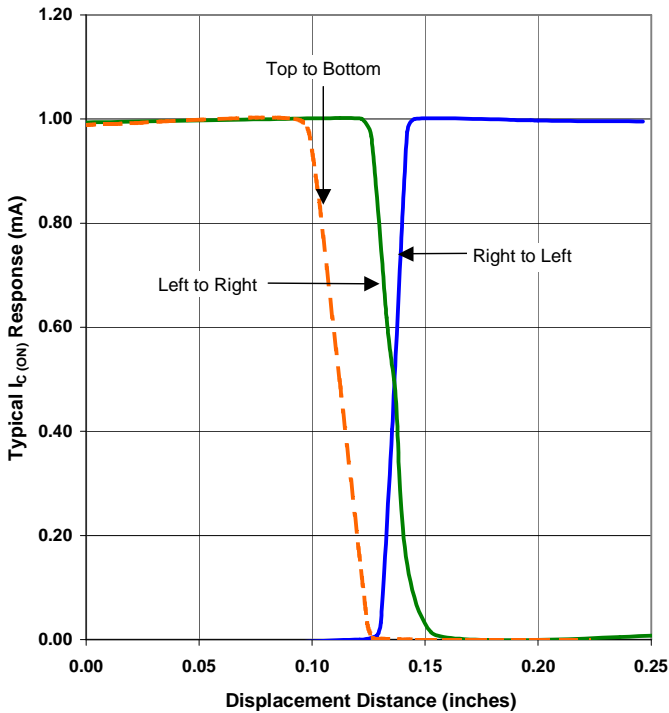

OPTEK reserves the right to make changes at any time in order to improve design and to supply the best product possible.

# Slotted Optical Switch

Series: OPB355, OPB360, OPB370, OPB380, OPB390

OPB859, OPB860, OPB870, OPB880, OPB890



Aperture Configuration 11 - Flag Next to Emitter

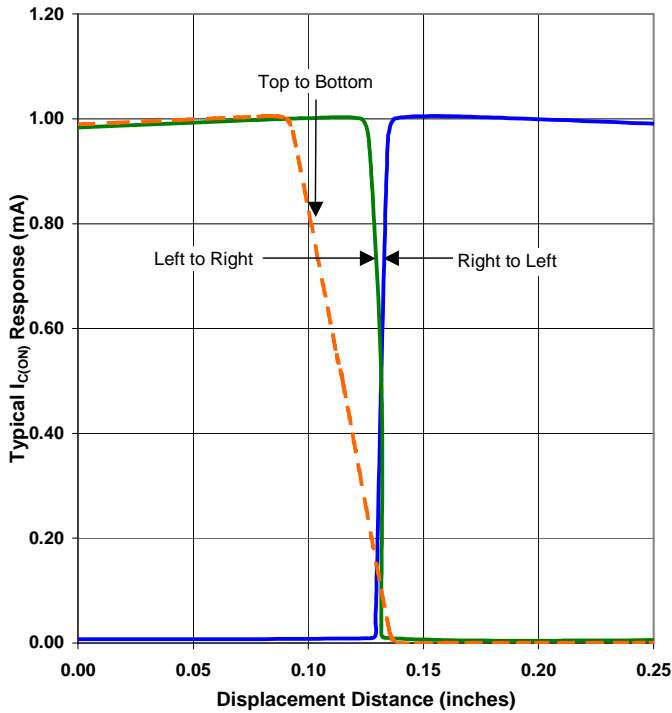

Aperture Configuration 11 - Flag Next to Sensor

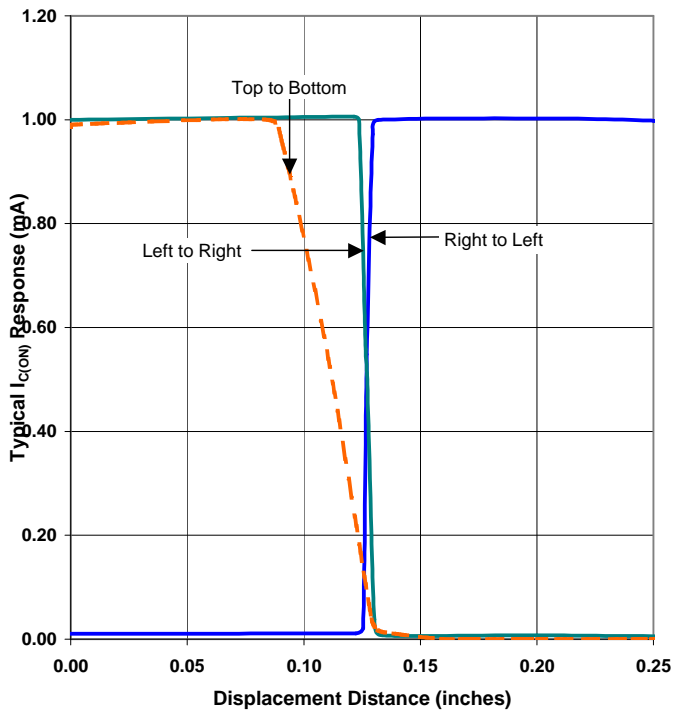

Aperture Configuration 11 - Flag in Middle of Slot

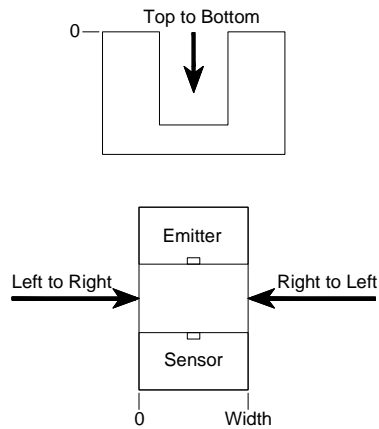
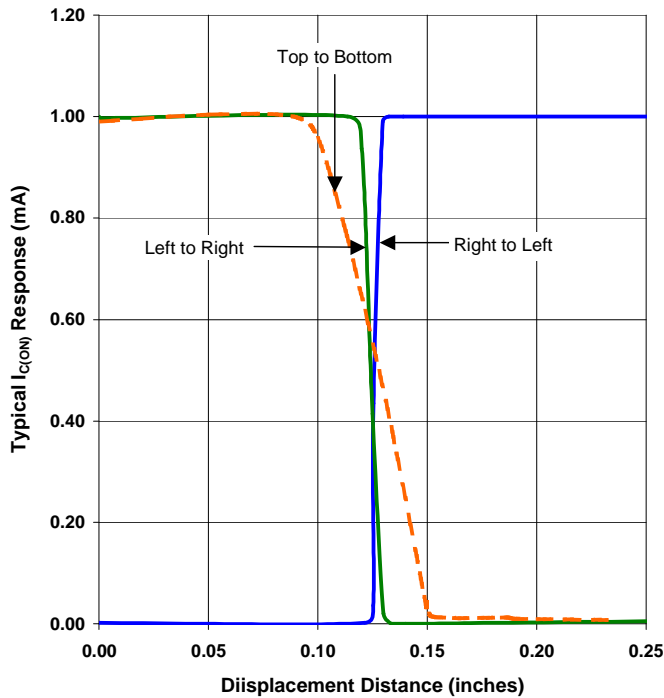

OPTEK reserves the right to make changes at any time in order to improve design and to supply the best product possible.



# Slotted Optical Switch

Series: OPB355, OPB360, OPB370, OPB380, OPB390

OPB859, OPB860, OPB870, OPB880, OPB890



Aperture Configuration 51 - Flag Next to Emitter

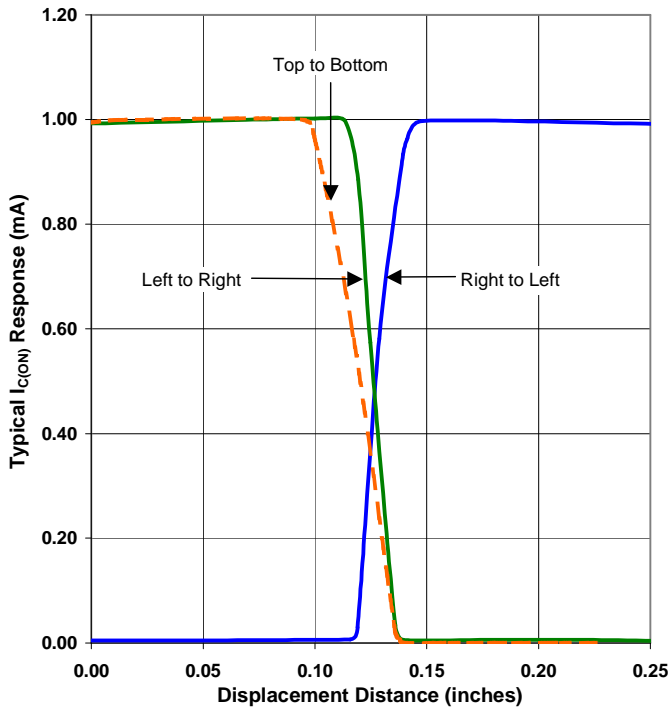

Aperture Configuration 51 - Flag Next to Sensor

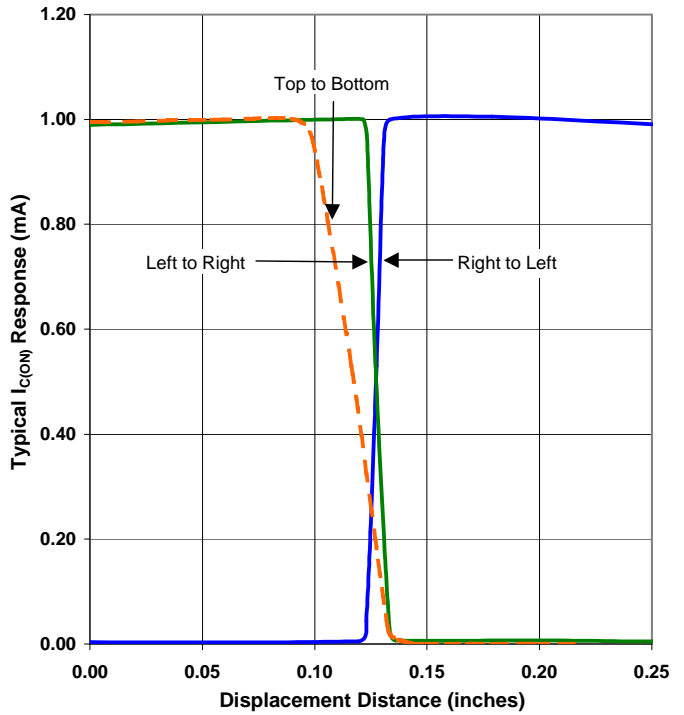

Aperture Configuration 51 - Flag in Middle of Slot

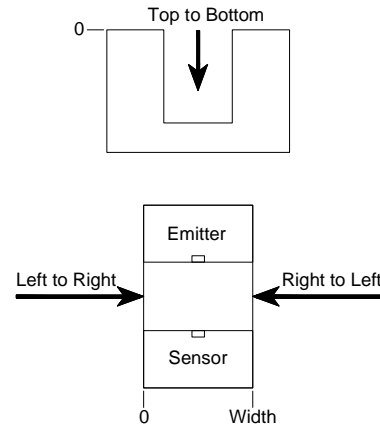
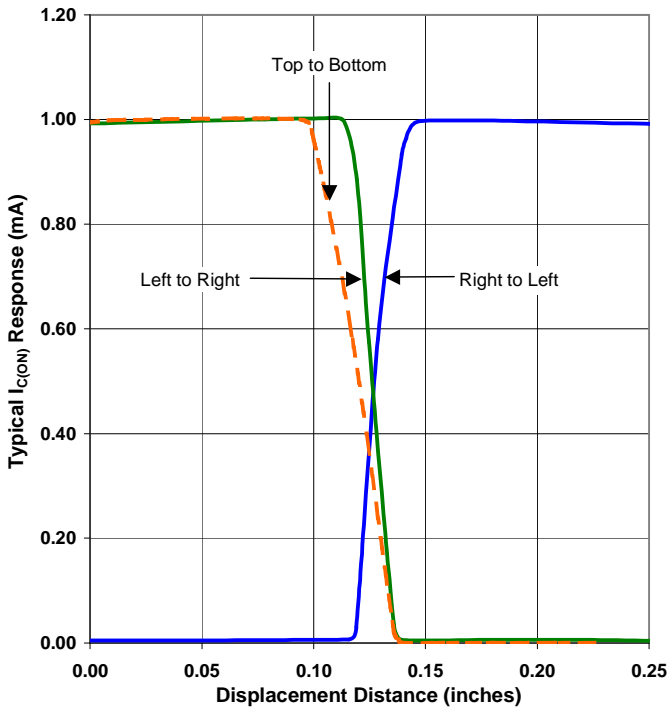

OPTEK reserves the right to make changes at any time in order to improve design and to supply the best product possible.

# Slotted Optical Switch

Series: OPB355, OPB360, OPB370, OPB380, OPB390  
 OPB859, OPB860, OPB870, OPB880, OPB890



Aperture Configuration 55 - Flag Next to Emitter

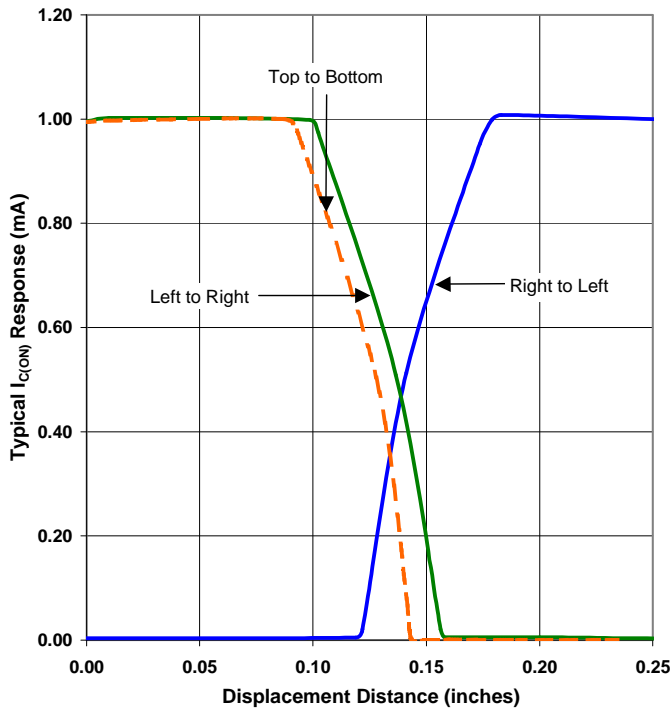

Aperture Configuration 55 - Flag Next to Sensor

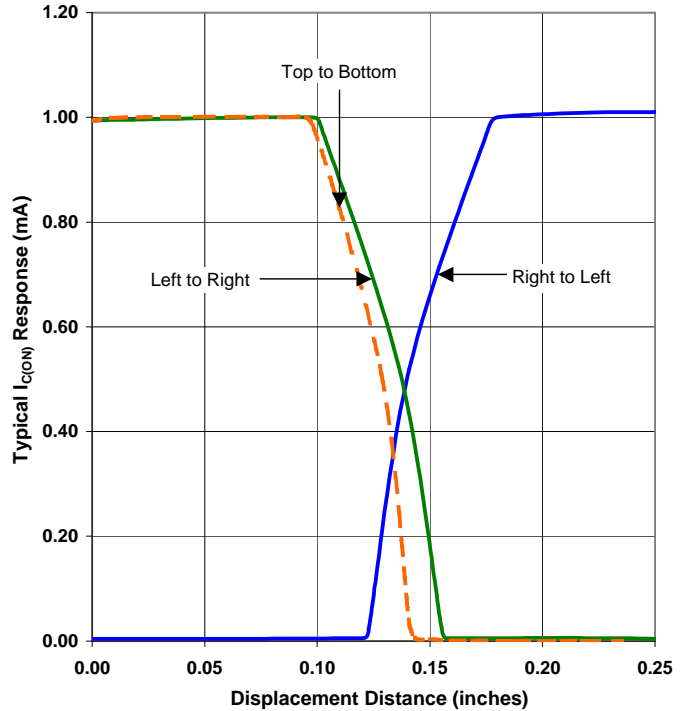

Aperture Configuration 55 - Flag in Middle of Slot

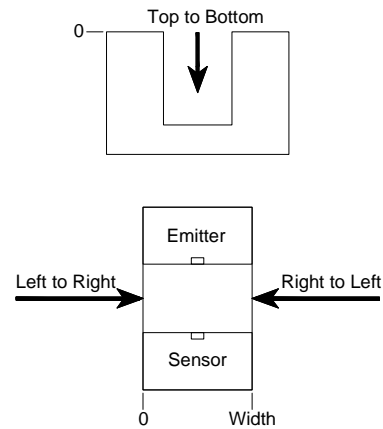
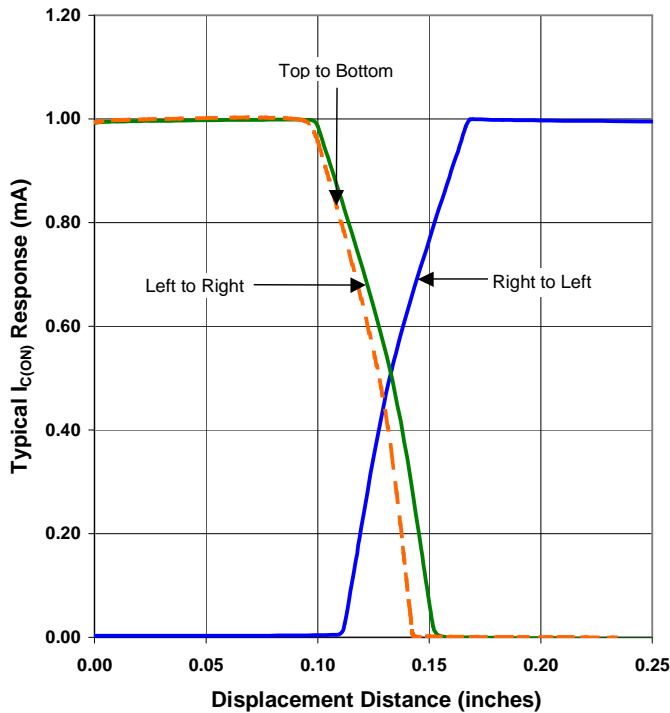

OPTEK reserves the right to make changes at any time in order to improve design and to supply the best product possible.