

PIN Silicon Photodiode

Type OP906

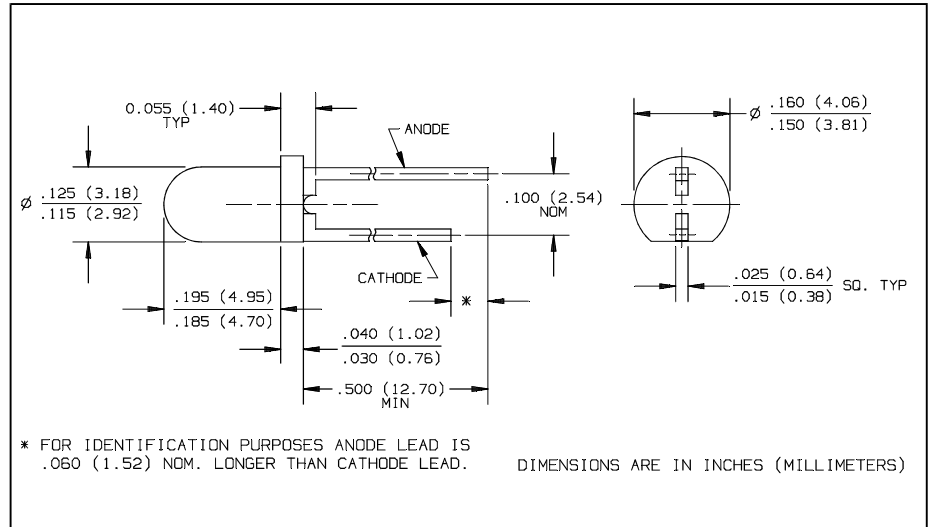

Features

- Narrow receiving angle
- Linear response vs irradiance
- Fast switching time
- T-1 package style
- Small package ideal for space limited applications

Description

The OP906 device consists of a PIN silicon photodiode molded in a clear epoxy package which allows spectral response from visible to infrared light wavelengths. The narrow receiving angle provides excellent on-axis coupling. These devices are 100% production tested using infrared light for close correlation with Optek's GaAs and GaAlAs emitters. Lead spacing is 0.100 inch (2.54 mm).

Absolute Maximum Ratings ($T_A = 25^\circ\text{C}$ unless otherwise noted)

Reverse Breakdown Voltage	60 V
Storage and Operating Temperature Range	-40°C to $+100^\circ\text{C}$
Lead Soldering Temperature [1/16 inch (1.6 mm) from case for 5 sec. with soldering iron]	$260^\circ\text{C}^{(1)}$
Power Dissipation	100 mW ⁽²⁾

Notes:

- (1) RMA flux is recommended. Duration can be extended to 10 sec. max. when flow soldering. Max. 20 grams force may be applied to leads when soldering.
- (2) Derate linearly 1.67 mW/ $^\circ\text{C}$ above 25°C .
- (3) Light source is an unfiltered GaAs LED with a peak emission wavelength of 935nm and a radiometric intensity level which varies less than 10% over the entire lens surface of the photodiode being tested.
- (4) To calculate typical dark current in nA, use the formula $I_D = 10^{(0.042 T_A - 1.5)}$ where T_A is ambient temperature in $^\circ\text{C}$.

Typical Performance Curves

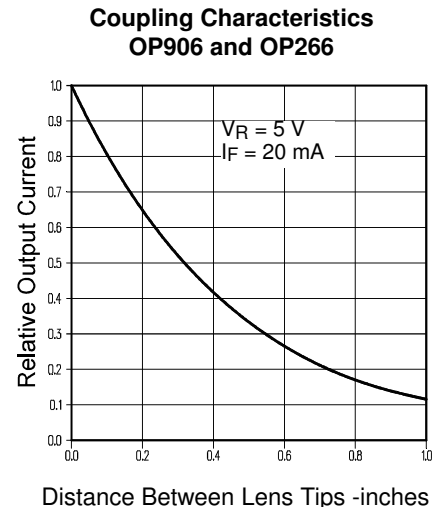
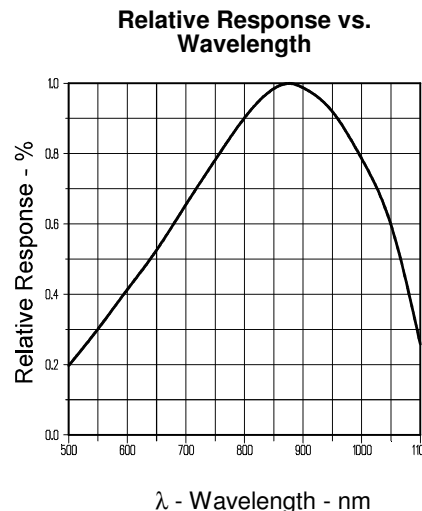

Type OP906

Electrical Characteristics ($T_A = 25^\circ\text{C}$ unless otherwise noted)

SYMBOL	PARAMETER	MIN	TYP	MAX	UNITS	TEST CONDITIONS
I_L	Reverse Light Current	16		35	μA	$V_R = 5\text{ V}$, $E_e = 0.50\text{ mW/cm}^2(3)$
I_D	Reverse Dark Current		1	60	nA	$V_R = 30\text{ V}$, $E_e = 0$
$V_{(BR)R}$	Reverse Breakdown Voltage	60			V	$I_R = 100\ \mu\text{A}$
V_F	Forward Voltage			1.2	V	$I_F = 1\text{ mA}$
C_T	Total Capacitance		4		pF	$V_R = 20\text{ V}$, $E_e = 0$, $f = 1.0\text{ MHz}$
t_r, t_f	Rise Time, Fall Time		5		ns	$V_R = 20\text{ V}$, $\lambda = 850\text{ nm}$, $R_L = 50\ \Omega$

PHOTOSENSORS

Typical Performance Curves

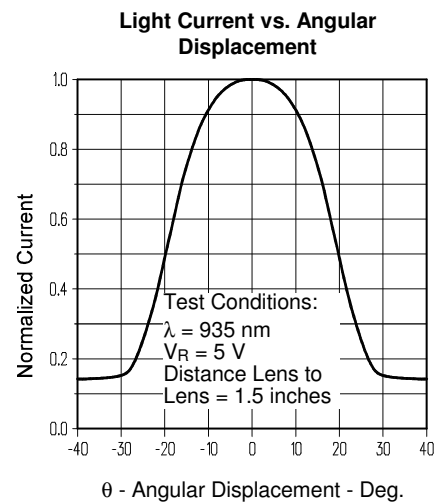
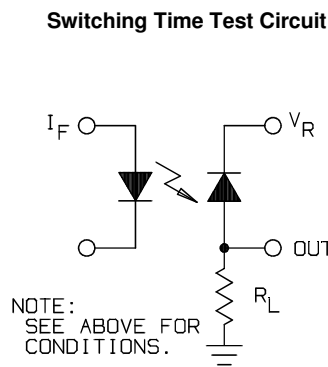
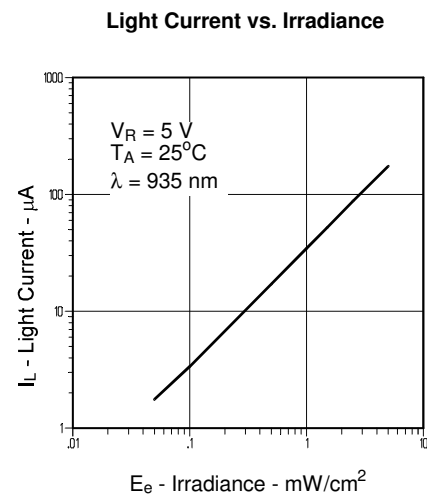
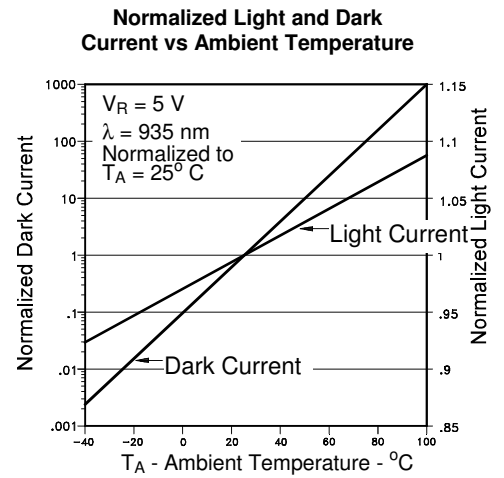
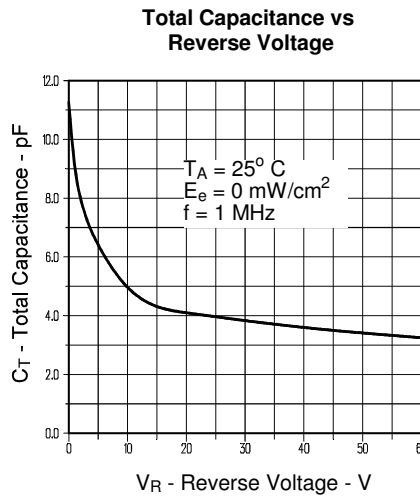
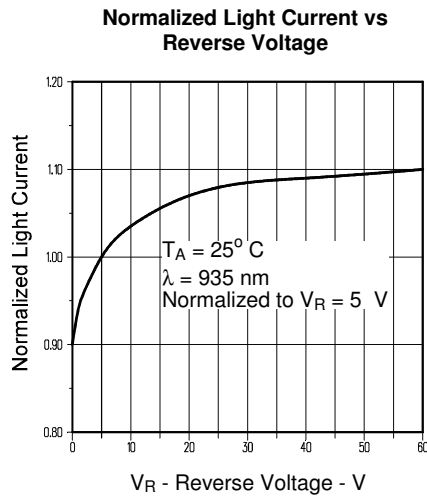

Optek reserves the right to make changes at any time in order to improve design and to supply the best product possible.

Optek Technology, Inc. 1215 W. Crosby Road Carrollton, Texas 75006 (972)323-2200 Fax (972)323-2396