

NPN Silicon Photodarlington Type OP830WSL

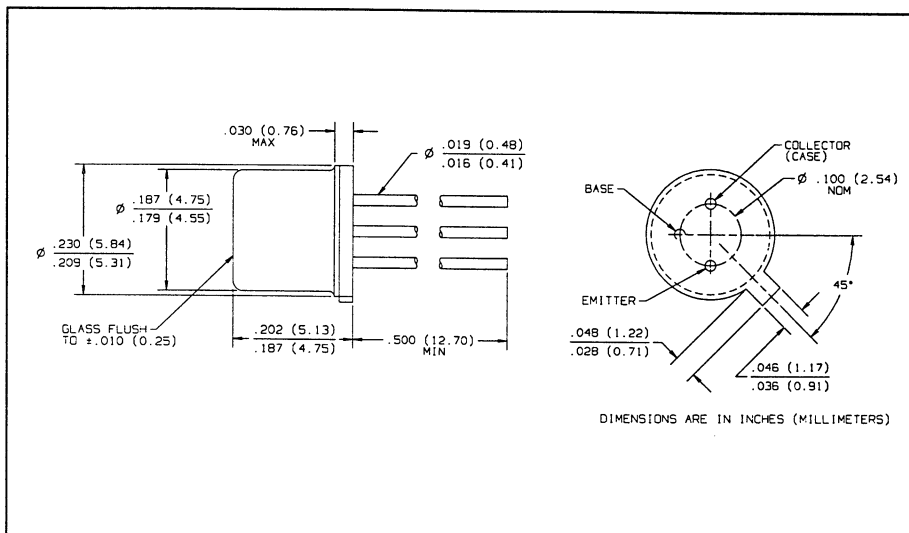
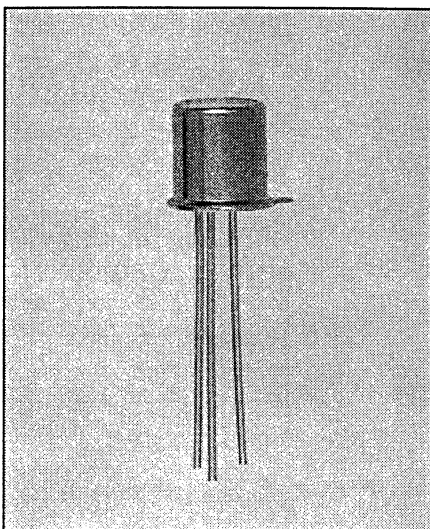

Features

- Wide receiving angle
- Enhanced temperature range
- Excellent thermal characteristics
- TO-18 hermetically sealed package
- Mechanically and spectrally matched to the OP130W and OP231W series of infrared emitting diodes

Description

The OP830WSL consists of an NPN silicon photodarlington mounted in a hermetically sealed package. The wide receiving angle provides relatively even reception over a large area.

Photodarlington devices are normally used in applications where light signal levels are low and more current gain is needed than is possible with phototransistors. TO-18 packages offer high power dissipation and superior hostile environment operation.

Replaces

OP830W and K9030 series

Absolute Maximum Ratings ($T_A = 25^\circ\text{C}$ unless otherwise noted)

Collector-Emitter Voltage	15 V
Emitter-Collector Voltage	5 V
Continuous Collector Current	50 mA
Storage Temperature Range	-65°C to $+150^\circ\text{C}$
Operating Temperature Range	-55°C to $+125^\circ\text{C}$
Lead Soldering Temperature [1/16 inch (1.6 mm) from case for 5 sec. with soldering iron]	$260^\circ\text{C}^{(1)}$
Power Dissipation	$250\text{ mW}^{(2)}$

Notes:

- (1) RMA flux is recommended. Duration can be extended to 10 sec. max. when flow soldering.
- (2) Derate linearly $2.5\text{ mW}/^\circ\text{C}$ above 25°C .
- (3) Junction temperature maintained at 25°C .
- (4) Light source is an unfiltered tungsten bulb operating at $CT = 2870\text{ K}$ or equivalent infrared source.

Typical Performance Curves

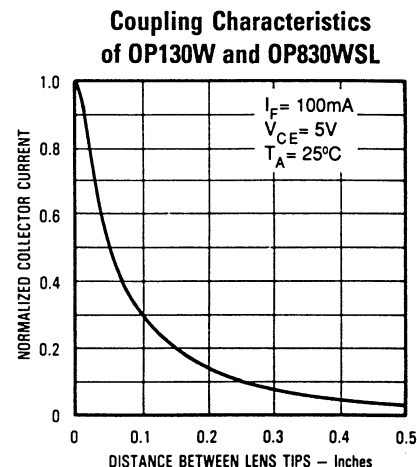
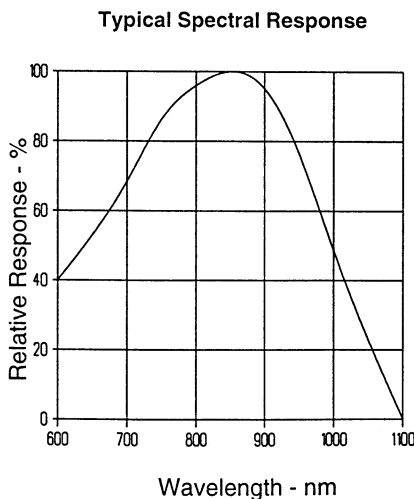

OP830WSL

Electrical Characteristics ($T_A = 25^\circ\text{C}$ unless otherwise noted)

SYMBOL	PARAMETER	MIN	TYP	MAX	UNITS	TEST CONDITIONS
$I_{C(ON)}^{(3)}$	On-State Collector Current	4			mA	$V_{CE} = 5\text{ V}$, $E_e = 0.5\text{ mW/cm}^2$ ⁽⁴⁾
I_{CEO}	Collector Dark Current			1.0	μA	$V_{CE} = 10\text{ V}$
$V_{(BR)CEO}$	Collector-Emitter Breakdown Voltage	15			V	$I_C = 100\ \mu\text{A}$
$V_{(BR)ECO}$	Emitter-Collector Breakdown Voltage	5.0			V	$I_E = 100\ \mu\text{A}$
$V_{CE(SAT)}^{(3)}$	Collector-Emitter Saturation Voltage			1.20	V	$I_C = 1.0\text{ mA}$, $E_e = 0.5\text{ mW/cm}^2$ ⁽⁴⁾

Typical Performance Curves

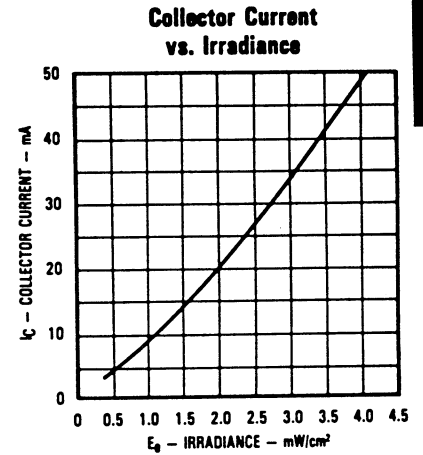
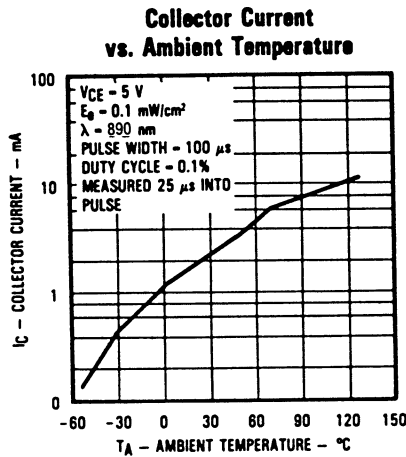
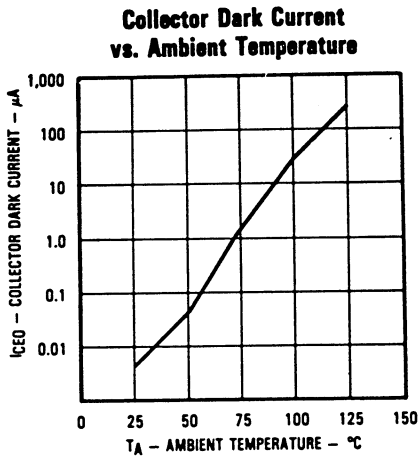

PHOTOSENSORS

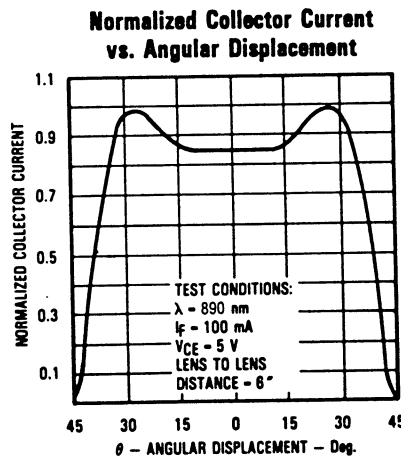
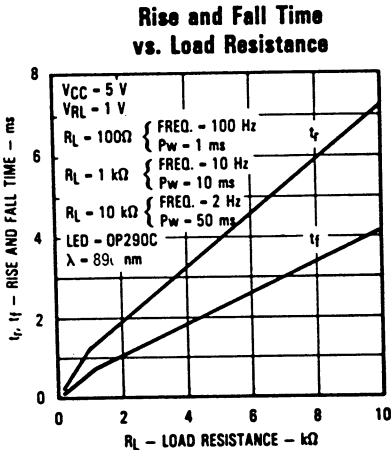

Switching Time Test Circuit

