

**SY3417 / SY3417(B)**

**1. Features**

- ◆ Yellow colored transparency lens type
- ◆  $\phi 3\text{mm(T-1)}$  all plastic mold type
- ◆ Low power consumption

**2. Outline Dimensions**

unit : mm

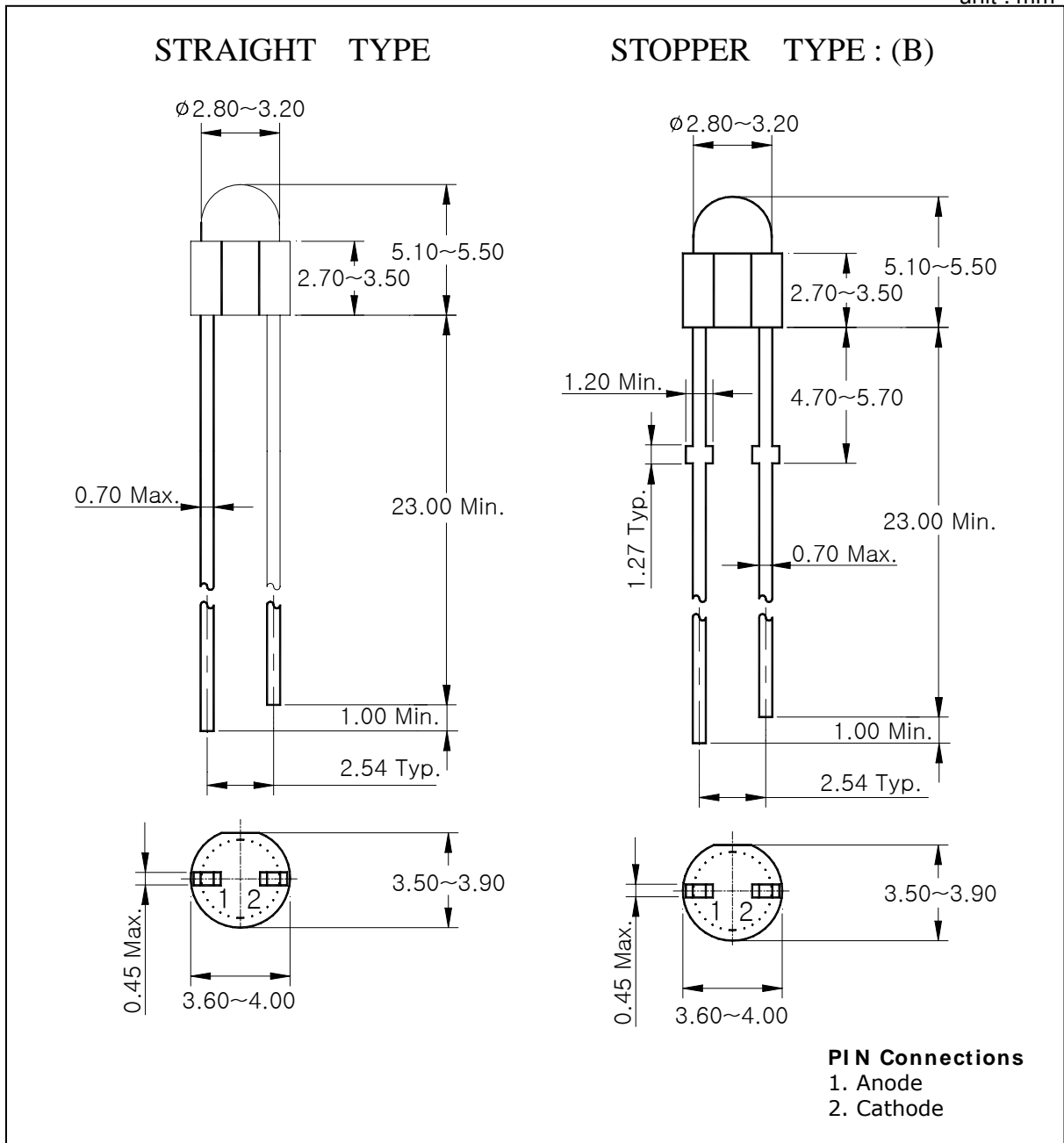

The contents of this data sheet are subject to change without advance notice for the purpose of improvement. When using this product, would you please refer to the latest specifications.

### 3. Absolute Maximum Ratings

(Ta=25°C)

| Characteristic              | Symbol    | Rating               | Unit |
|-----------------------------|-----------|----------------------|------|
| Power dissipation           | $P_D$     | 75                   | mW   |
| Forward current             | $I_F$     | 30                   | mA   |
| *1Peak forward current      | $I_{FP}$  | 50                   | mA   |
| Reverse voltage             | $V_R$     | 4                    | V    |
| Operating temperature range | $T_{opr}$ | -25~85               | °C   |
| Storage temperature range   | $T_{stg}$ | -30~100              | °C   |
| *2Soldering temperature     | $T_{sol}$ | 260°C for 10 seconds |      |

\*1.Duty ratio = 1/16, Pulse width = 0.1ms

\*2.Keep the distance more than 2.0mm from PCB to the bottom of LED package

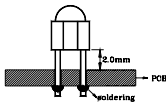

### 4. Electrical / Optical Characteristics

(Ta=25°C)

| Characteristic       | Symbol          | Test Condition    | Min | Typ      | Max | Unit |
|----------------------|-----------------|-------------------|-----|----------|-----|------|
| Forward voltage      | $V_F$           | $I_F=20\text{mA}$ | -   | 2.1      | 2.5 | V    |
| *3Luminous intensity | $I_V$           | $I_F=20\text{mA}$ | 27  | -        | 155 | mcd  |
| Dominant wavelength  | $\lambda_D$     | $I_F=20\text{mA}$ | 583 | 588      | 592 | nm   |
| Spectrum bandwidth   | $\Delta\lambda$ | $I_F=20\text{mA}$ | -   | 30       | -   | nm   |
| Reverse current      | $I_R$           | $V_R=4\text{V}$   | -   | -        | 10  | uA   |
| *4Half angle         | $\theta_{1/2}$  | $I_F=20\text{mA}$ | -   | $\pm 17$ | -   | deg  |

\*4.  $\theta_{1/2}$  is the off-axis angle where the luminous intensity is 1/2 the peak intensity\*3. Luminous intensity maximum tolerance for each grade classification limit is  $\pm 18\%$ 

\*3. Luminous Intensity Classification

| I       | J       | K        | L         |
|---------|---------|----------|-----------|
| 27 ~ 43 | 43 ~ 68 | 68 ~ 100 | 100 ~ 155 |

The contents of this data sheet are subject to change without advance notice for the purpose of improvement.  
When using this product, would you please refer to the latest specifications.

5. Characteristic Diagrams

Fig. 1  $I_F - V_F$

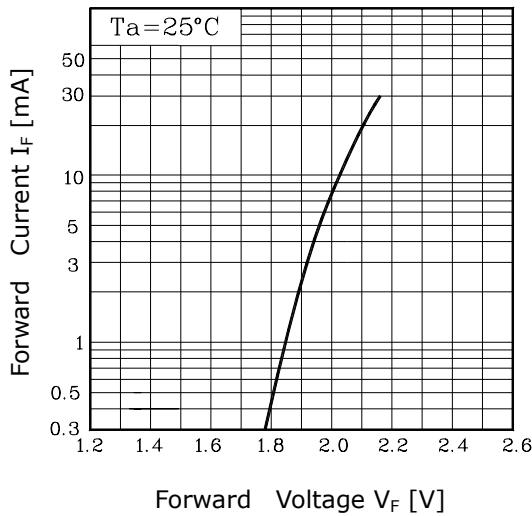

Fig. 2  $I_V - I_F$

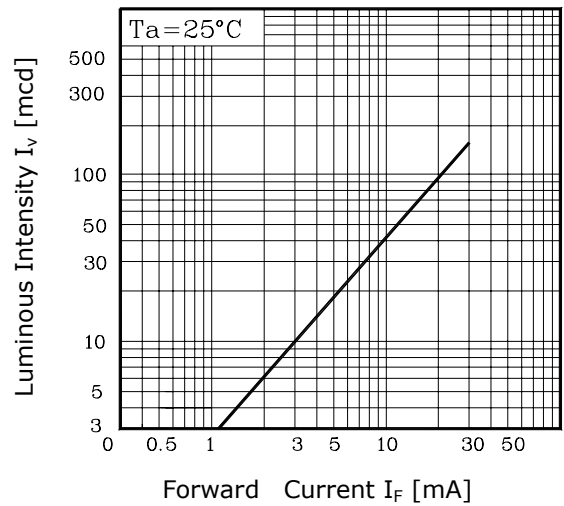

Fig. 3  $I_F - T_a$

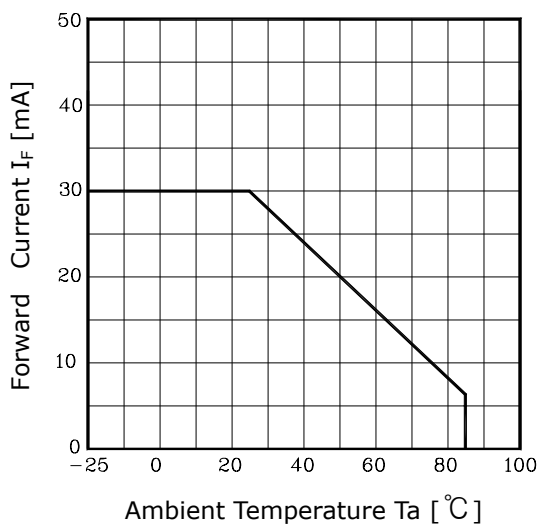

Fig.4 Spectrum Distribution

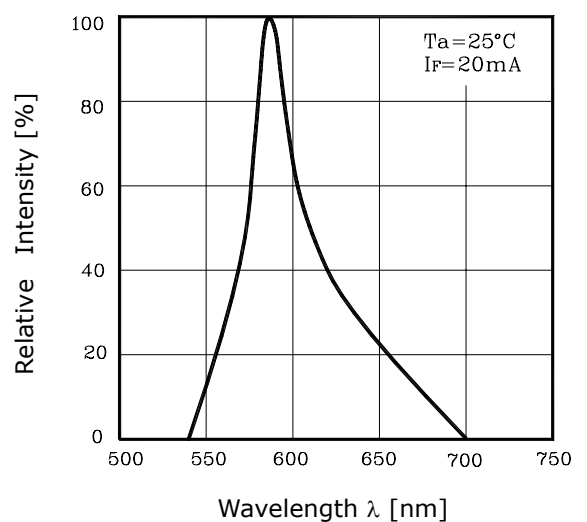
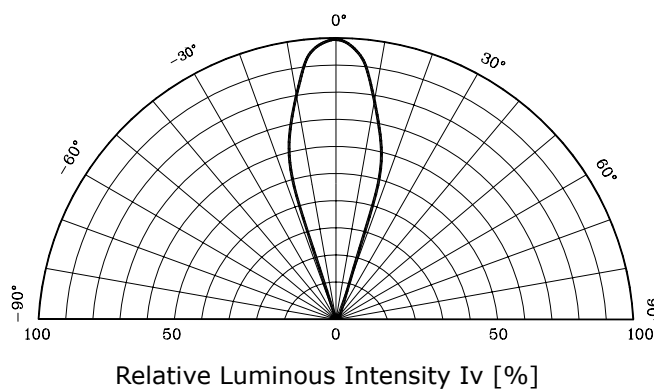

Fig. 5 Radiation Diagram



The contents of this data sheet are subject to change without advance notice for the purpose of improvement. When using this product, would you please refer to the latest specifications.