

1. Features

- ◆ Colorless transparency lens type
- ◆ Using a package with high heat dissipation properties, it can be driven with a large current
- ◆ Wide viewing angle
- ◆ Encapsulating Resin : Silicone Resin
- ◆ External dimensions : 3.5(L)×2.8(W)×1.9mm(T) surface mount type

2. Applications

- ◆ Backlighting
- ◆ Signal indicator
- ◆ Symbol backlighting
- ◆ Front panel indicator

3. Outline Dimensions

unit : mm

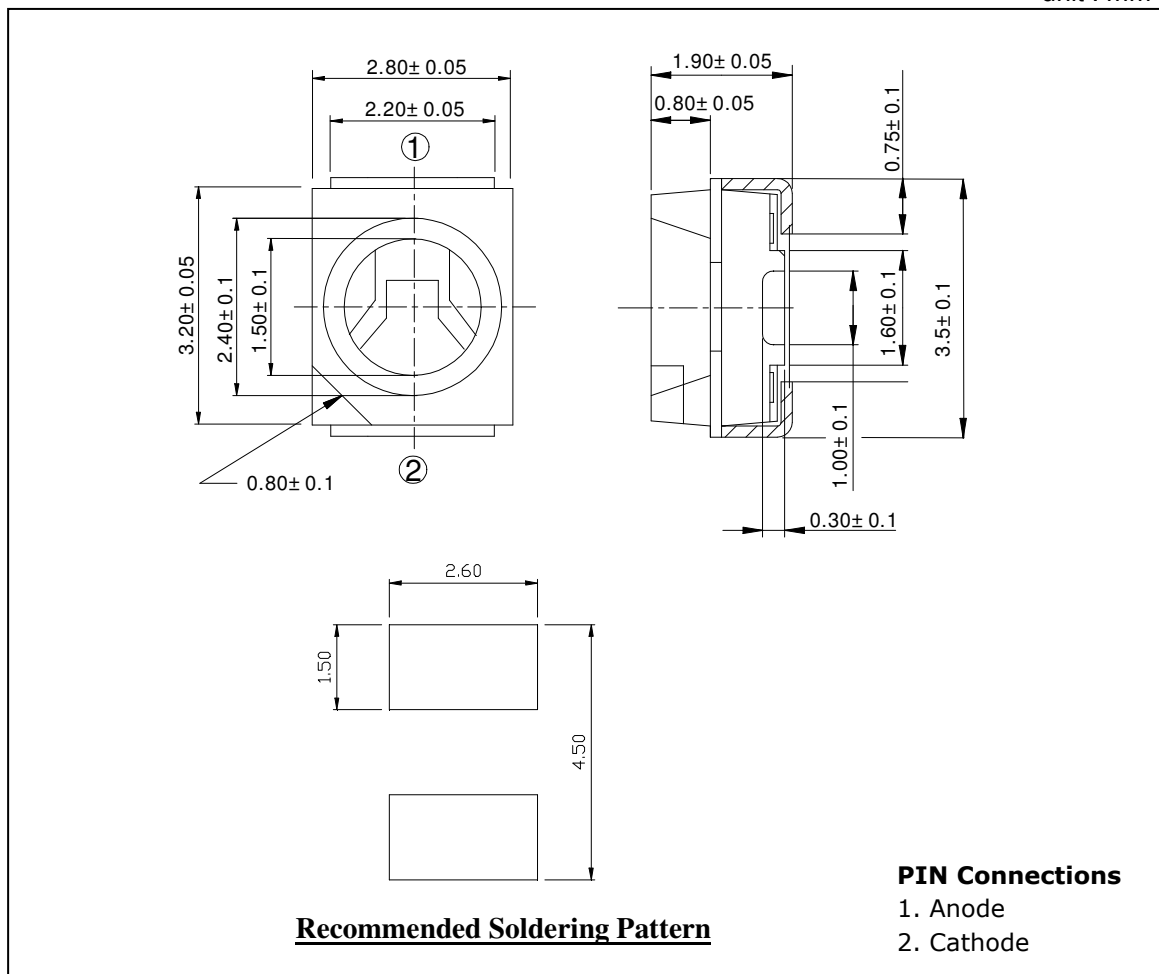

The contents of this data sheet are subject to change without advance notice for the purpose of improvement. When using this product, would you please refer to the latest specifications.

4. Absolute Maximum Ratings

(Ta=25°C)

Characteristic	Symbol	Rating	Unit
Power dissipation	P_D	70	mW
Forward current	I_F	30	mA
*1 Peak forward current	I_{FP}	50	mA
Reverse voltage	V_R	5	V
Operating temperature range	T_{opr}	-40~100	°C
Storage temperature range	T_{stg}	-40~110	°C
*2 Soldering temperature	T_{sol}	240°C for 10 seconds	

*1. Duty ratio = 1/16, Pulse width = 0.1ms

*2. Recommended reflow soldering temperature profile

- Preheating 150°C to 185°C within 120 seconds soldering 240°C within 10 seconds
- Gradual cooling (Avoid quenching)

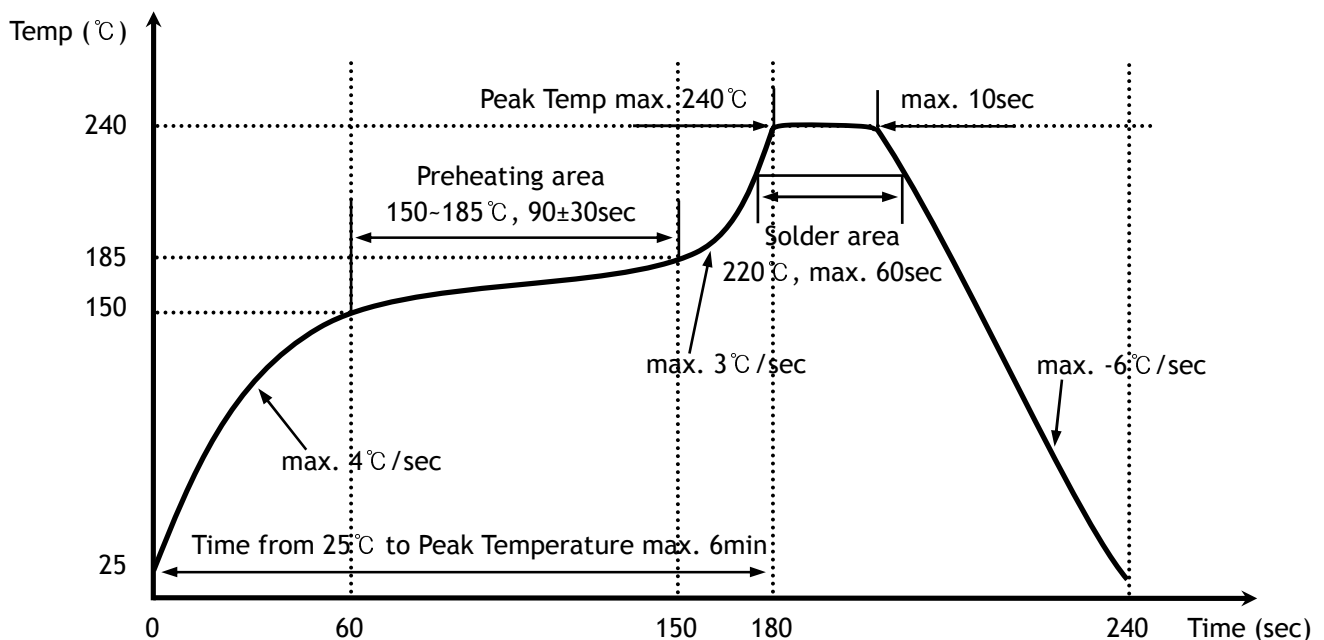

The contents of this data sheet are subject to change without advance notice for the purpose of improvement. When using this product, would you please refer to the latest specifications.

5. Electrical / Optical Characteristics

(Ta=25°C)

Characteristic	Symbol	Test Condition	Min	Typ	Max	Unit
Forward voltage	V_F	$I_F=20\text{mA}$	1.85	-	2.3	V
*3 Luminous intensity	I_V	$I_F=20\text{mA}$	220	-	410	mcd
Dominant wavelength	λ_D	$I_F=20\text{mA}$	600	604	608	nm
Spectrum bandwidth	$\Delta\lambda$	$I_F=20\text{mA}$	-	35	-	nm
Reverse current	I_R	$V_R=5\text{V}$	-	-	10	μA
*4 Half angle	$\theta/2$	$I_F=20\text{mA}$	-	± 60	-	deg

*3.The test result of $I_F=20\text{mA}$ is only for reference

*4. $\theta/2$ is the off-axis angle where the luminous intensity is 1/2 the peak intensity

◆ V_F / I_V Grade Classification (Ta=25°C)

Test Condition @ $I_F=20\text{mA}$	
Forward Voltage [V]	Luminous Intensity [mcd]
1 : 1.85~2.1	N : 220~310
2 : 2.1~2.3	O : 310~410

(Each V_F , I_V range did not consider a margin. Please refer to $\pm 0.1\text{V}$ of V_F range, $\pm 18\%$ of I_V range as a permitted limit and do not use to combine grade classification. It must be used separately grade classification)

The contents of this data sheet are subject to change without advance notice for the purpose of improvement. When using this product, would you please refer to the latest specifications.

▪ Precaution for handling Silicone Resin LED

- The encapsulated resin of the LEDs is silicone. So LEDs have a soft surface on the top of the package. The pressure to the top surface will be influence to the reliability of the LEDs. Precaution should be taken to avoid the strong pressure on the encapsulated part.

- Housings using a silicone resin attract dust more compared to standard encapsulation.

It is recommended that a suitable cleaning solution must be applied to the surface after soldering.

1. Handling indications

1) When users handle the SMT LEDs, mechanical stress on the surface should be minimized as much as possible. Sharp objects of all types should not be used to pierce the sealing compound.



2) LED should only be handled from the side. Silicone resin is softer than generally used Epoxy resin.

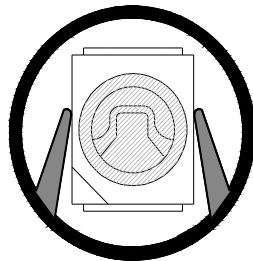

3) When users operate the chip lifter, the picking up nozzle which does not affect the soft surface should be used. This is assured by choosing the picking up nozzle which is larger than the LED reflecting area.

2. Cleaning indication

1) It is strongly recommended that isopropyl alcohol be used as a solvent. When using other solvents, it should be confirmed beforehand whether the solvents will dissolve the package and the resin or not. Freon solvents should not be used to clean the LEDs because of worldwide regulations.

2) Do not clean the LEDs by the ultrasonic. When it is absolutely necessary, the influence of ultrasonic cleaning on the LEDs depends on factors such as ultrasonic power and the assembled condition.

Before cleaning, a pre- test should be done to confirm whether any damage to the LEDs will occur.

The contents of this data sheet are subject to change without advance notice for the purpose of improvement. When using this product, would you please refer to the latest specifications.

6. Characteristic Diagrams

Fig. 1 $I_F - V_F$

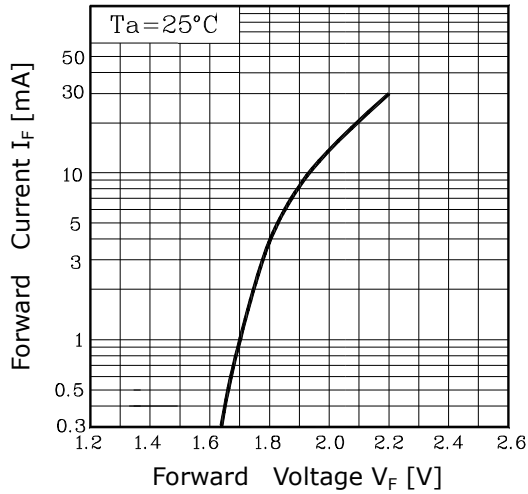

Fig. 2 $I_V - I_F$

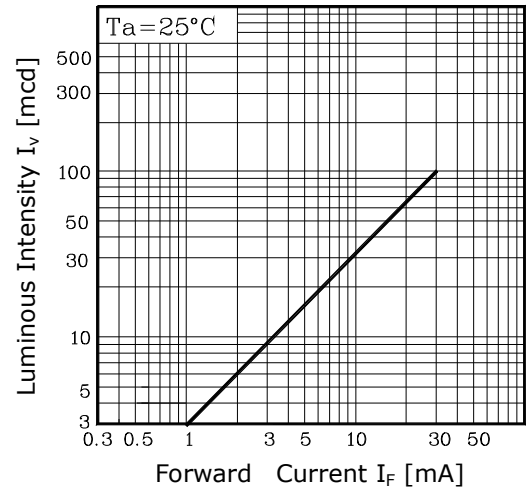

Fig. 3 $I_F - T_a$

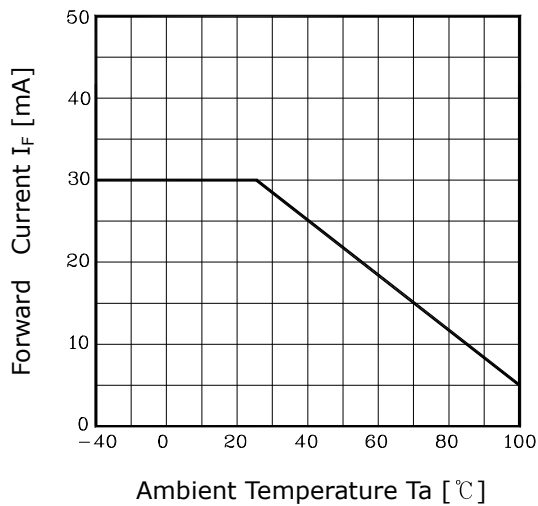

Fig.4 Spectrum Distribution

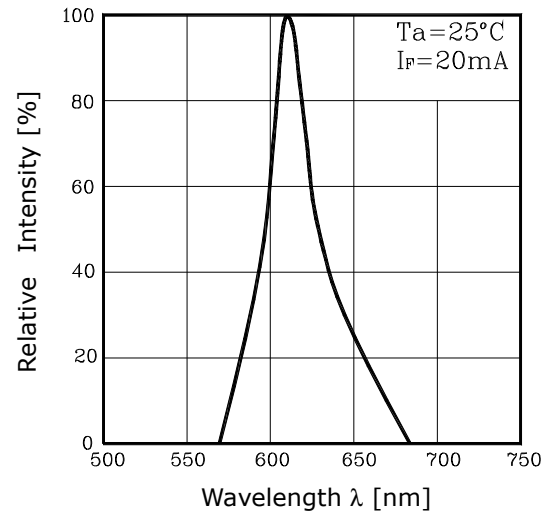
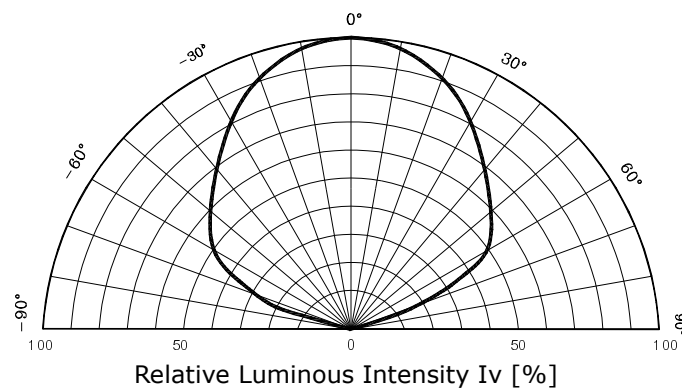

Fig. 5 Radiation Diagram



The contents of this data sheet are subject to change without advance notice for the purpose of improvement. When using this product, would you please refer to the latest specifications.