

## Descriptions

- Dual chip digital transistor

## Features

- Two SRA2201 Chips in SOT-363 Package.
- Simplify circuit design
- Reduce a quantity of parts and manufacturing process

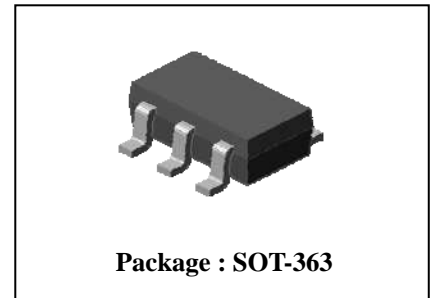

## Ordering Information

Type NO.	Marking	Package Code
SUR560J	OXO□	SOT-363

□ : Year & Week Code

## Equivalent circuit & PIN Connections

• Equivalent Circuit

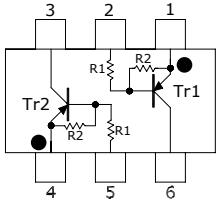

	R <sub>1</sub>	R <sub>2</sub>
Tr1	4.7KΩ	4.7KΩ
Tr2	4.7KΩ	4.7KΩ

**PIN Connections**

1. COMMON 1
2. IN 1
3. OUT 2
4. COMMON 2
5. IN 2
6. OUT 1

## Absolute Maximum Ratings [Tr1, Tr2]

(Ta=25°C)

Characteristic	Symbol	Rating	Unit
Output voltage	V <sub>O</sub>	-50	V
Input voltage	V <sub>I</sub>	-20, 10	V
Output current	I <sub>O</sub>	-100	mA
Power dissipation	P <sub>D</sub> <sup>*</sup>	200	mW
Junction temperature	T <sub>J</sub>	150	°C
Storage temperature range	T <sub>stg</sub>	-55 ~ 150	°C

※: Total rating

**Electrical Characteristics [Tr1, Tr2]****(Ta=25°C)**

Characteristic	Symbol	Test Condition	Min.	Typ.	Max.	Unit
Output cut-off current	$I_{O(OFF)}$	$V_O=-50V, V_I=0$	-	-	-500	nA
DC current gain	$G_I$	$V_O=-5V, I_O=-10mA$	30	55	-	-
Output voltage	$V_{O(ON)}$	$I_O=-10mA, I_I=-0.5mA$	-	-0.1	-0.3	V
Input voltage (ON)	$V_{I(ON)}$	$V_O=-0.2V, I_O=-5mA$	-	-1.5	-2.0	V
Input voltage (OFF)	$V_{I(OFF)}$	$V_O=-5V, I_O=-0.1mA$	-1.0	-1.2	-	V
Transition frequency	$f_T^*$	$V_O=-10V, I_O=-5mA, f=1MHz$	-	200	-	MHz
Input current	$I_I$	$V_I=-5V, I_O=0$	-	-	-1.8	mA
Input resistor (Input to base)	$R_1$	-	3.3	4.7	6.1	K $\Omega$
Input resistor (Base to common)	$R_2$	-	3.3	4.7	6.1	K $\Omega$

\* : Characteristic of transistor only

**Electrical Characteristic Curves**  
**[Tr1,Tr2]**

**Fig. 1  $I_o - V_{I(ON)}$**

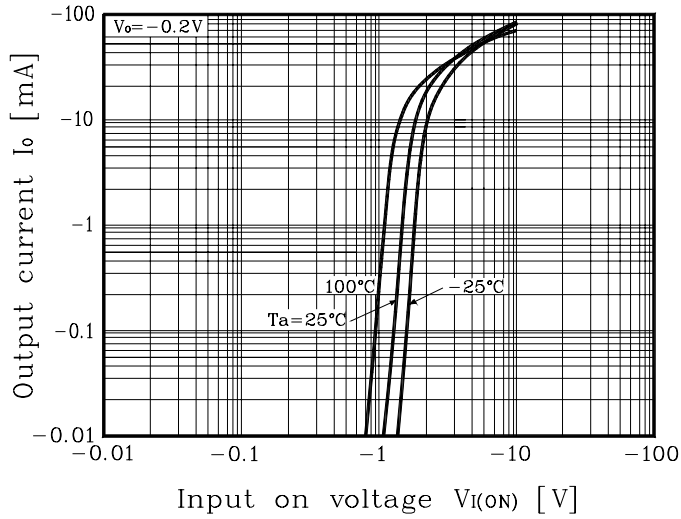

**Fig. 2  $I_o - V_{I(OFF)}$**

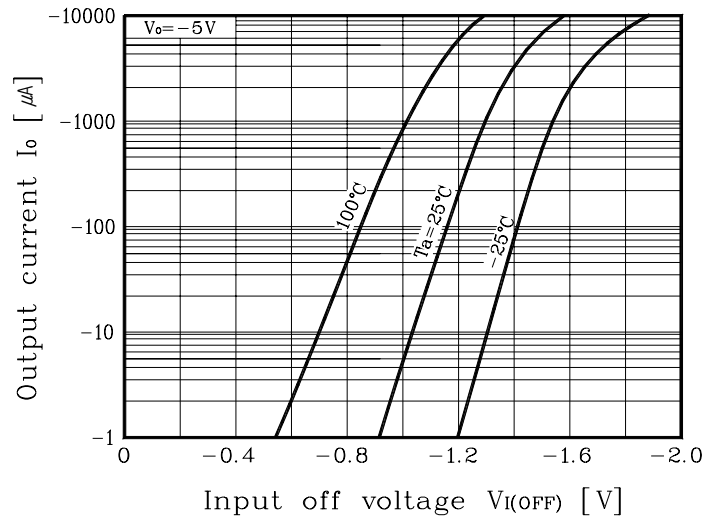

**Fig. 3  $G_I - I_o$**

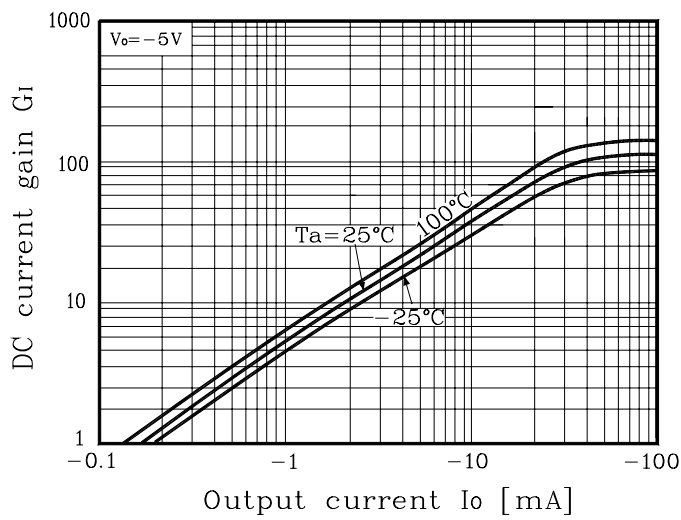

Outline Dimension

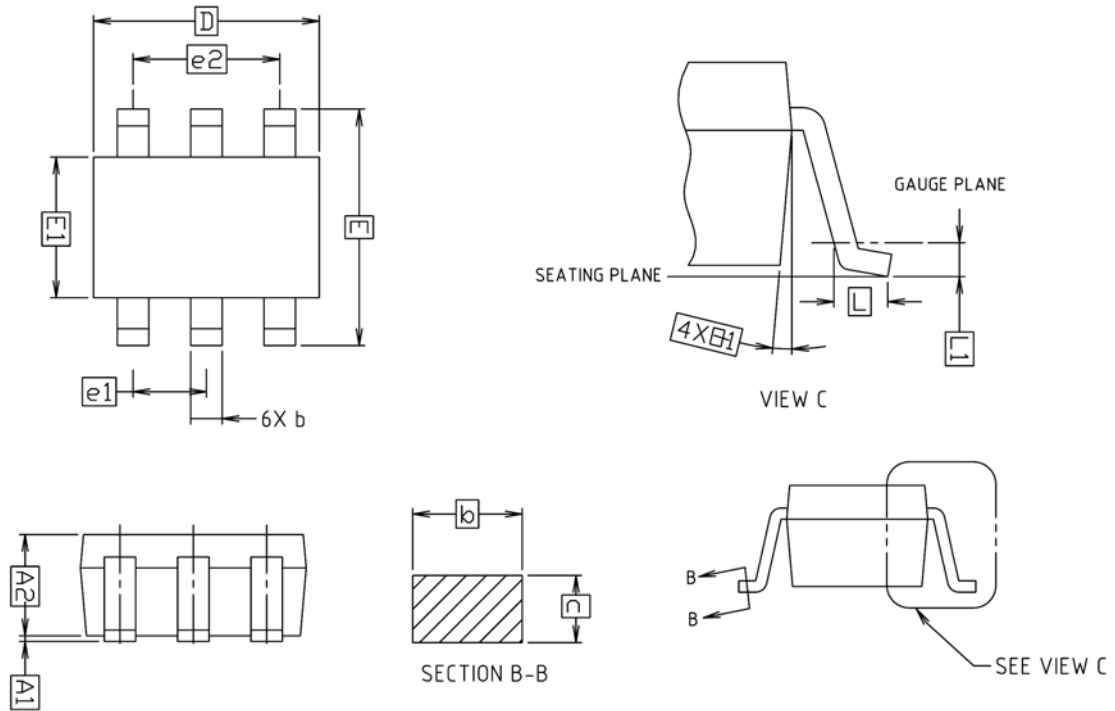

SYMBOL	MILLIMETERS			NOTE
	MINIMUM	NOMINAL	MAXIMUM	
A1	0.00	-	0.10	
A2	0.90	0.95	1.00	
b	0.25	-	0.40	
c	0.10	-	0.25	
D	1.90	2.00	2.10	
E	1.95	2.10	2.25	
E1	1.15	1.25	1.35	
e1	0.65 BSC			
e2	1.30 BSC			
L	0.25	-	-	
L1	0.15 BSC			

※ Recommend PCB solder land [Unit: mm]

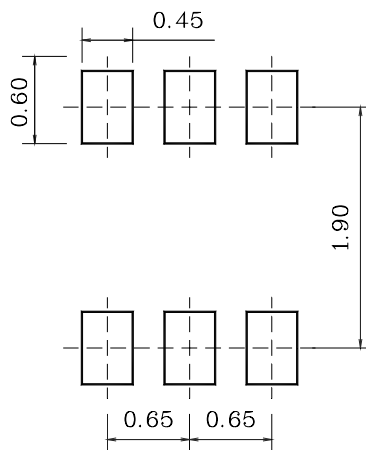

**The AUK Corp. products are intended for the use as components in general electronic equipment (Office and communication equipment, measuring equipment, home appliance, etc.).**

**Please make sure that you consult with us before you use these AUK Corp. products in equipments which require high quality and / or reliability, and in equipments which could have major impact to the welfare of human life(atomic energy control, airplane, spaceship, transportation, combustion control, all types of safety device, etc.). AUK Corp. cannot accept liability to any damage which may occur in case these AUK Corp. products were used in the mentioned equipments without prior consultation with AUK Corp..**

**Specifications mentioned in this publication are subject to change without notice.**