

Applications

- Power amplifier application
- High current switching application

Features

- Power transistor General Purpose application
- Low saturation voltage
: $V_{CE(sat)} = 0.4V$ (Typ.)
- High Voltage: $V_{CEO} = 60V$ Min

PIN Connection

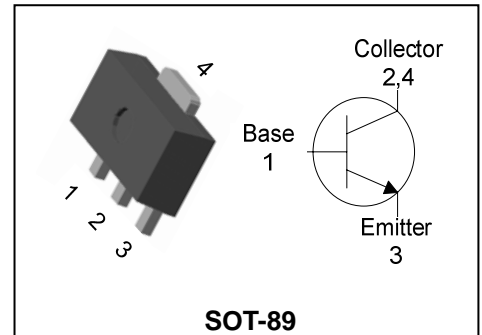

Ordering Information

Type No.	Marking	Package Code
STC403F	C403 YWW	SOT-89

C403: DEVICE CODE, YWW(Y : Year code, WW : Weekly code)

Absolute Maximum Ratings

[$T_a = 25^\circ\text{C}$]

Characteristic	Symbol	Rating	Unit
Collector-Base voltage	V_{CBO}	80	V
Collector-Emitter voltage	V_{CEO}	60	V
Emitter-base voltage	V_{EBO}	5	V
Collector current	I_C	3	A(DC)
	I_{CP}^*	6	A(Pulse)
Collector Power dissipation	P_C	0.5	W
	P_C^{**}	1	
Junction temperature	T_j	150	$^\circ\text{C}$
Storage temperature	T_{stg}	-55~150	$^\circ\text{C}$

* : Single pulse, $t_p = 300 \mu\text{s}$

** : When mounted on ceramic substrate($250 \text{ mm}^2 \times 0.8 \text{ t}$)

Electrical Characteristics

(Ta=25°C)

Characteristic	Symbol	Test Condition	Min.	Typ.	Max.	Unit	
Collector-Emitter breakdown voltage	BV_{CEO}	$I_C = 50\text{mA}, I_B = 0$	60	-	-	V	
Collector cut-off current	I_{CBO}	$V_{CB} = 60\text{V}, I_E = 0$	-	-	50	μA	
Emitter cut-off current	I_{EBO}	$V_{EB} = 5\text{V}, I_C = 0$	-	-	50	μA	
DC current gain	h_{FE}^*	$V_{CE} = 5\text{V}, I_C = 0.5\text{A}$	200	-	400	-	
Base-Emitter on voltage	$V_{BE(ON)}$	$V_{CE} = 5\text{V}, I_C = 0.5\text{A}$	-	0.7	1	V	
Collector-Emitter saturation voltage	$V_{CE(sat)}$	$I_C = 2\text{A}, I_B = 0.2\text{A}$	-	0.4	1	V	
Transition frequency	f_T	$V_{CB} = 5\text{V}, I_C = 0.5\text{A}$	-	30	-	MHz	
Collector output capacitance	C_{ob}	$V_{CB} = 10\text{V}, I_E = 0, f = 1\text{MHz}$	-	35	-	pF	
Switching Time	Turn-on Time	t_{on}	<p>$I_{B1} = -I_{B2} = 0.2\text{A}$ DUTY CYCLE $\leq 1\%$</p>	-	0.65	-	μs
	Storage Time	t_{stg}		-	1.3	-	
	Fall Time	t_f		-	0.65	-	

* h_{FE} rank : 200~400 Only

Electrical Characteristic Curves

Fig. 1 $P_C - T_a$

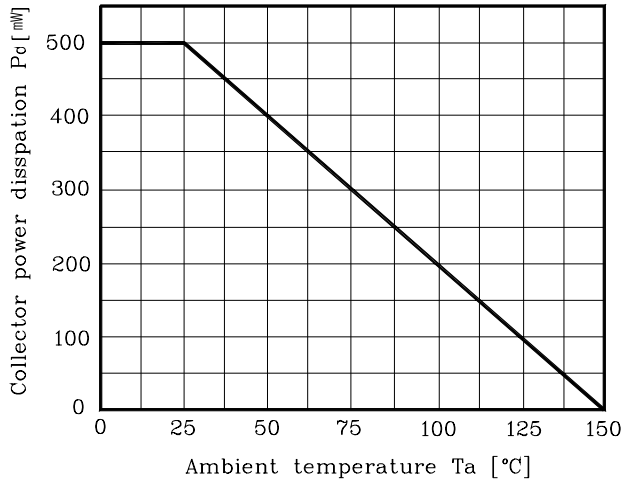

Fig. 2 $V_{CE} - I_C$

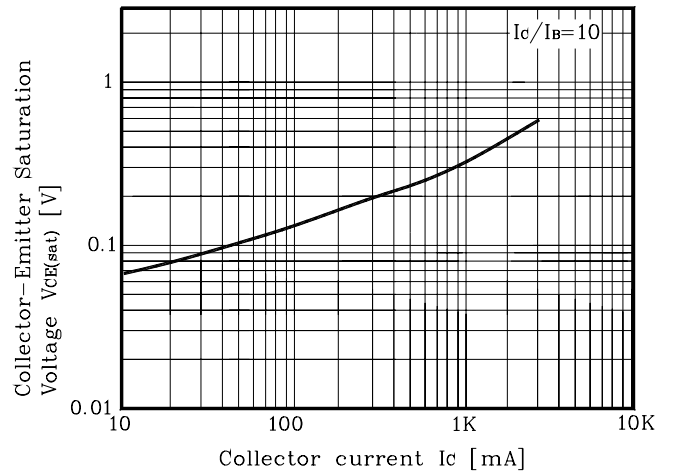

Fig. 3 $h_{FE} - I_C$

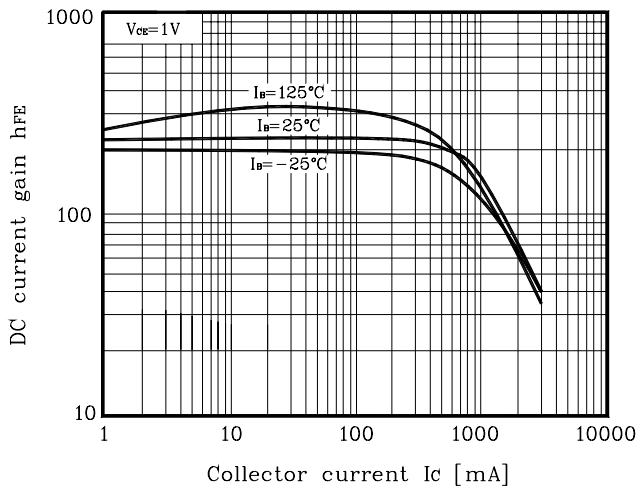

Fig. 4 $h_{FE} - I_C$

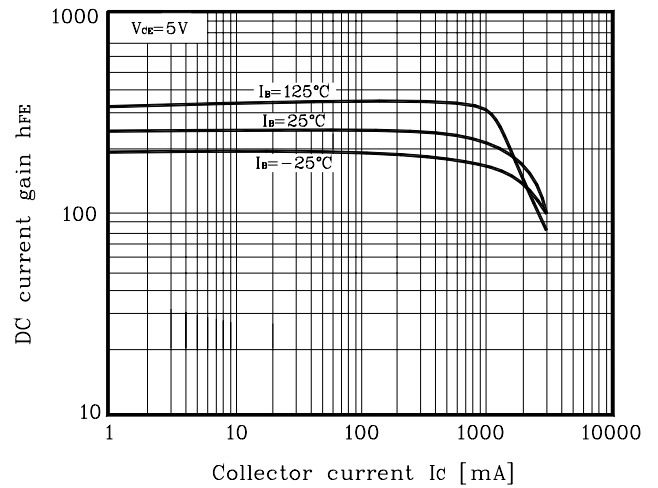

Fig. 5 $I_C - V_{CE}$

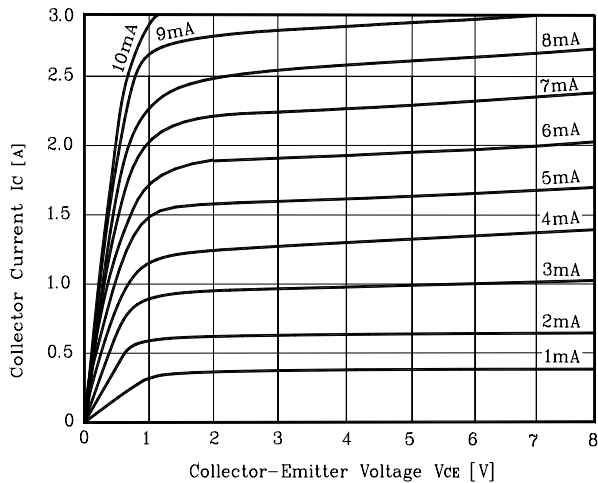
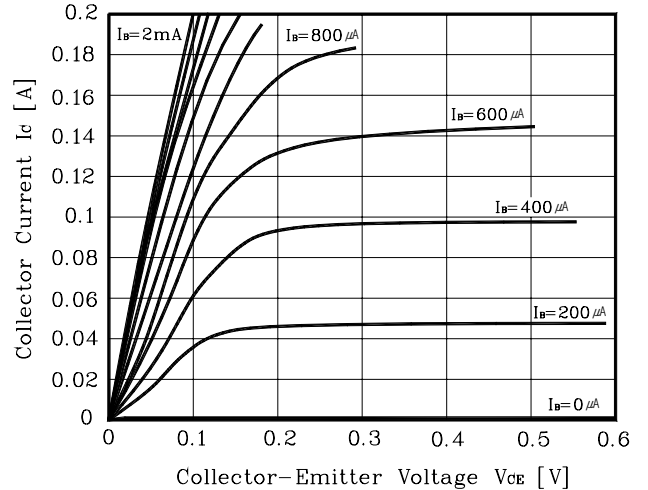
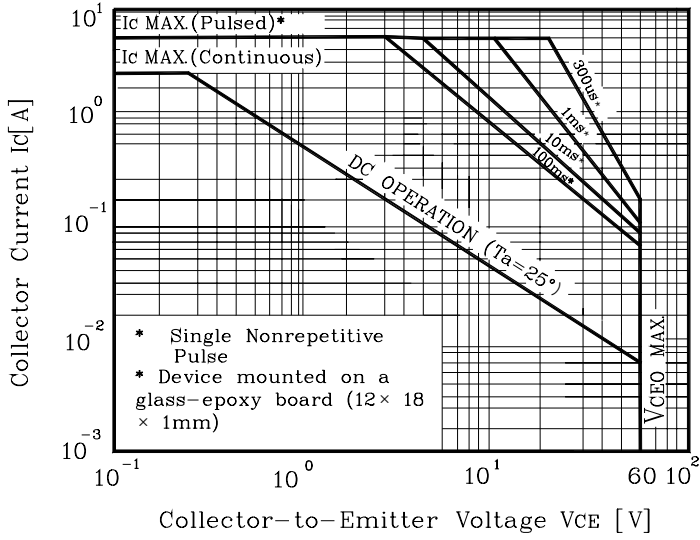

Fig. 6 $I_C - V_{CE}$



Electrical Characteristic Curves

Fig. 7 Safe operating Area



Outline Dimension(mm)

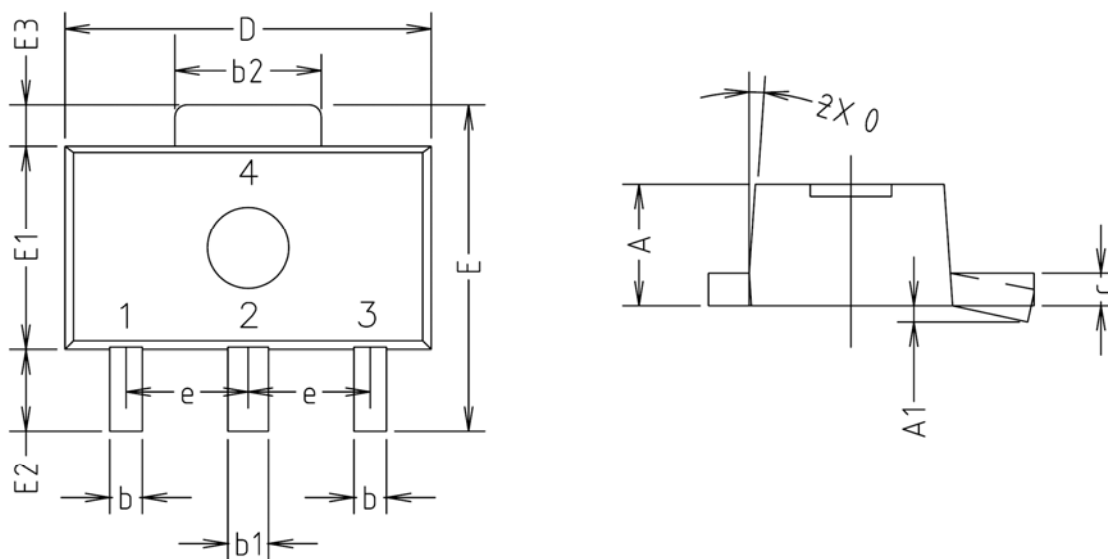

SYMBOL	MILLIMETERS			NOTE
	MINIMUM	NOMINAL	MAXIMUM	
A	1.40	1.50	1.60	
A1	0.00	—	0.10	
b	0.38	0.42	0.48	
b1	0.48	0.52	0.58	
b2	1.79	1.82	1.87	
c	0.40	0.42	0.46	
D	4.40	4.50	4.70	
E	3.70	4.00	4.30	
E1	2.40	2.50	2.70	
E2	0.80	1.00	1.20	
E3	0.40	0.50	0.60	
e	1.50 TYP.			
θ	4° TYP.			

※Recommend PCB solder land [Unit: mm]

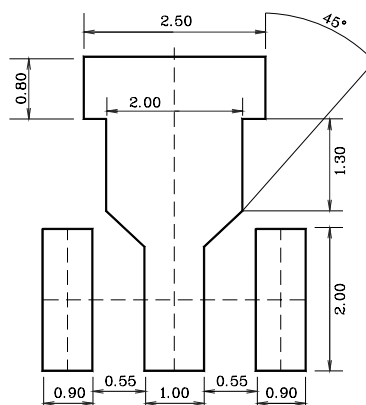

The AUK Corp. products are intended for the use as components in general electronic equipment (Office and communication equipment, measuring equipment, home appliance, etc.).

Please make sure that you consult with us before you use these AUK Corp. products in equipments which require high quality and / or reliability, and in equipments which could have major impact to the welfare of human life(atomic energy control, airplane, spaceship, transportation, combustion control, all types of safety device, etc.). AUK Corp. cannot accept liability to any damage which may occur in case these AUK Corp. products were used in the mentioned equipments without prior consultation with AUK Corp..

Specifications mentioned in this publication are subject to change without notice.