

Applications

- Power amplifier application
- High current switching application

Features

- Low saturation voltage
: $V_{CE(sat)} = -0.15V$ Typ. @ $I_C = -1A$, $I_B = -50mA$
- Large collector current capacity: $I_C = -3A$
- TO-220F-3L DIP type package

Ordering Information

Type NO.	Marking	Package Code
STA3360PI	STA3360	TO-220F-3L

PIN Connection

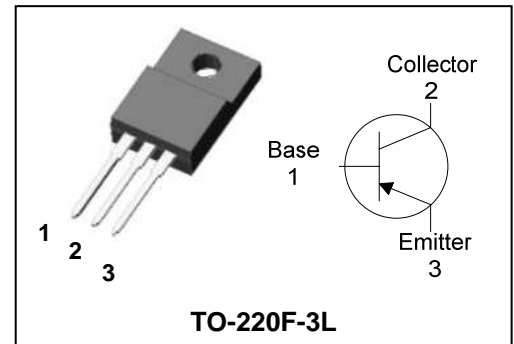

Marking Diagram

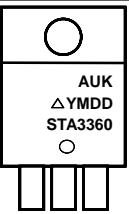
	Column 1 : Manufacturer Column 2 : Production Information - Δ : Factory Management Code - YMDD : Date Code (Year, Month, Date) Column 3 : Device Code
--	---

Absolute Maximum Ratings

[Ta=25°C]

Characteristic	Symbol	Rating	Unit
Collector-base voltage	V_{CBO}	-60	V
Collector-emitter voltage	V_{CEO}	-60	V
Emitter-base voltage	V_{EBO}	-6	V
Collector current	I_C	-3	A(DC)
	I_{CP}^*	-6	A(Pulse)
Collector Power dissipation($T_C = 25^\circ C$)	P_C	15	W
Junction temperature	T_J	150	°C
Storage temperature range	T_{stg}	-55~ 150	°C

 * : Single pulse, $t_p = 300 \mu s$

Characteristic	Symbol	Typ.	Max	Unit	
Thermal resistance	Junction-case	$R_{th(J-C)}$	-	8.33	°C/W
	Junction-ambient	$R_{th(J-a)}$	-	62.5	

Electrical Characteristics

[Ta=25°C]

Characteristic		Symbol	Test Condition	Min.	Typ.	Max.	Unit
Collector-emitter breakdown voltage		BV_{CEO}	$I_C = -1\text{mA}, I_B = 0$	-60	-	-	V
Collector cut-off current		I_{CBO}	$V_{CB} = -60\text{V}, I_E = 0$	-	-	-1	μA
Emitter cut-off current		I_{EBO}	$V_{EB} = -6\text{V}, I_C = 0$	-	-	-1	μA
DC current gain		h_{FE}	$V_{CE} = -2\text{V}, I_C = -0.5\text{A}^*$	120	-	240	-
		h_{FE}	$V_{CE} = -2\text{V}, I_C = -2\text{A}^*$	40	-	-	
Collector-emitter saturation voltage		$V_{CE(sat)}$	$I_C = -1\text{A}, I_B = -0.05\text{A}^*$	-	-	-0.35	V
Base-emitter saturation voltage		$V_{BE(sat)}$	$I_C = -2\text{A}, I_B = -0.1\text{A}^*$	-	-0.97	-1.2	V
Transition frequency		f_T	$V_{CE} = -10\text{V}, I_C = -0.05\text{A}$	-	160	-	MHz
Collector output capacitance		C_{ob}	$V_{CB} = -10\text{V}, I_E = 0, f = 1\text{MHz}$	-	60	-	pF
Switching Time	Turn-on Time	t_{on}		-	170	-	ns
	Storage Time	t_{stg}		-	620	-	
	Fall Time	t_f		-	50	-	

*: Pulse test : $t_p \leq 300\mu\text{s}$, Duty cycle $\leq 2\%$

Electrical Characteristic Curves

Fig. 1 $P_C - T_a$

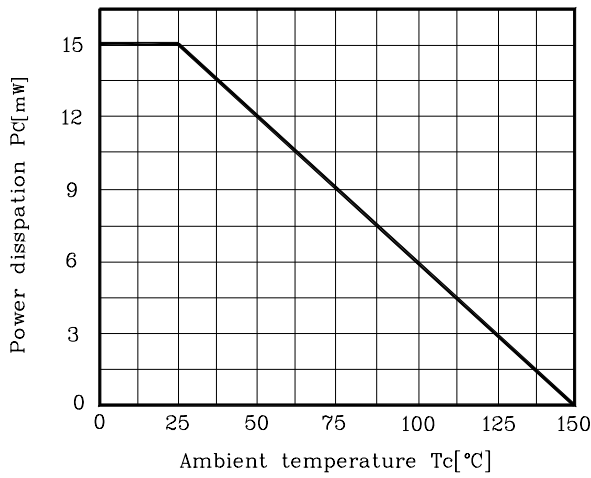

Fig. 2 $I_C - V_{BE(ON)}$

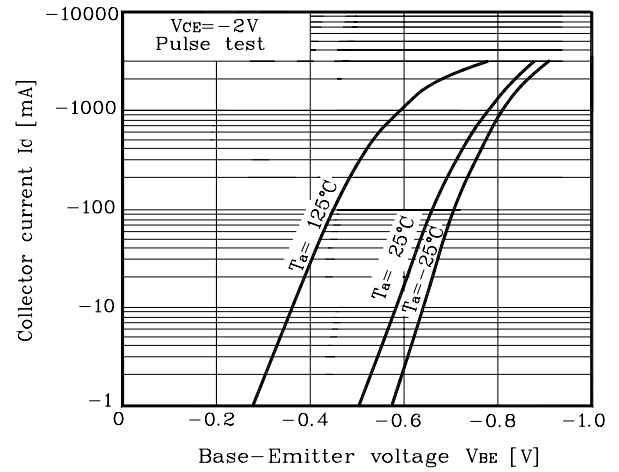

Fig. 3 $I_C - V_{CE}$

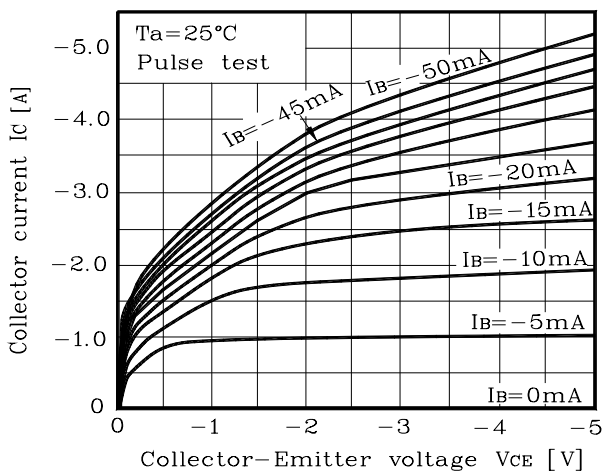

Fig. 4 $h_{FE} - I_C$

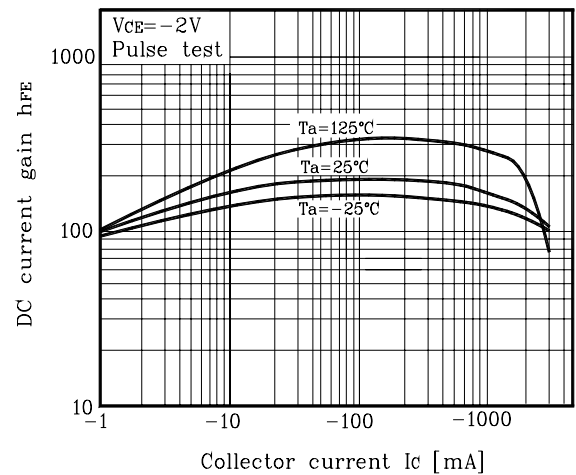

Fig. 5 $V_{CE(sat)} - I_C$

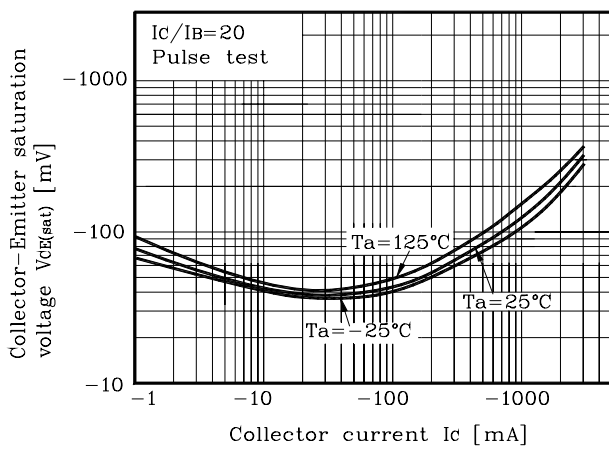
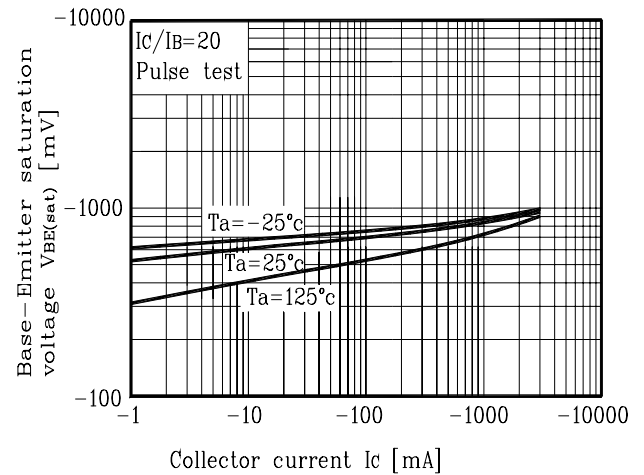

Fig. 6 $V_{BE(sat)} - I_C$



Electrical Characteristic Curves

Fig. 7 $C_{ob} - V_{CB}$

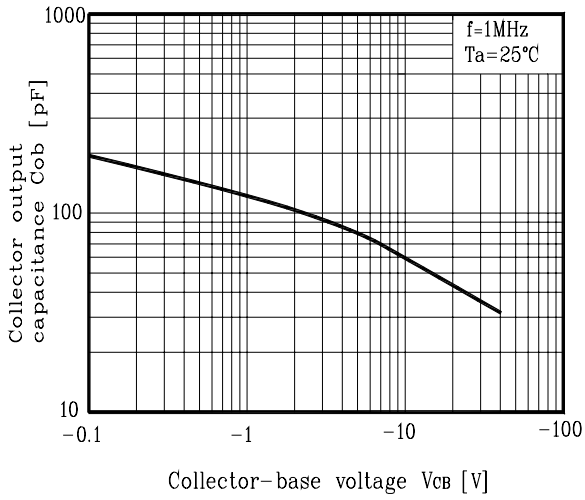
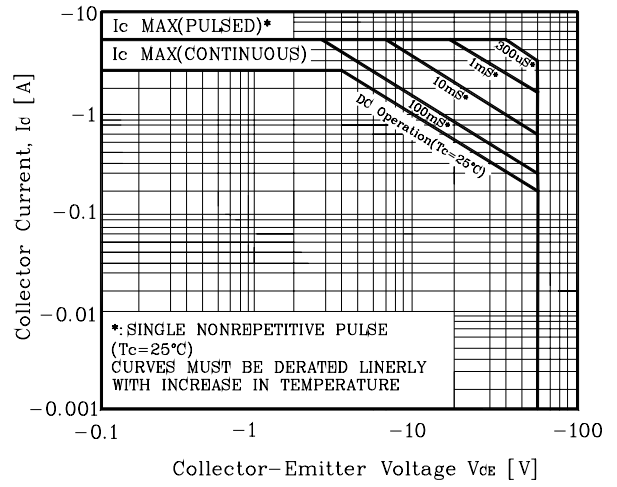
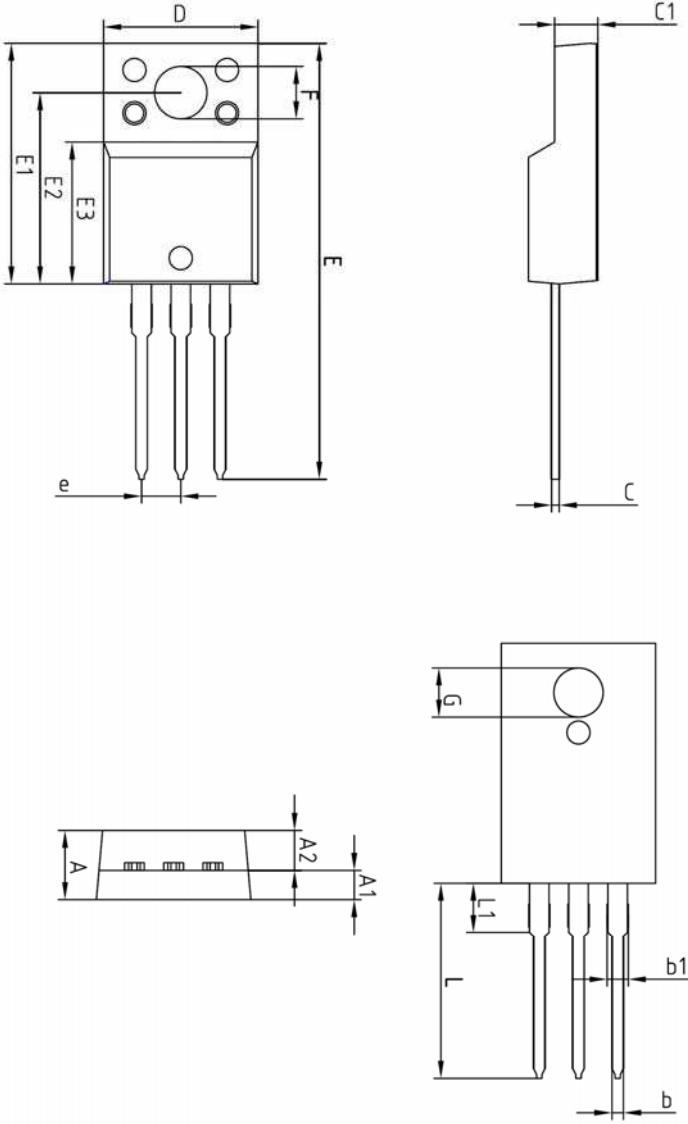

Fig. 8 Safe Operating Area



Outline Dimension



SYMBOL	MILLIMETERS			NOTE
	MINIMUM	NOMINAL	MAXIMUM	
A	-	-	4.60	
A1	2.45	2.50	2.55	
A2	1.95	2.00	2.05	
b	0.65	0.75	0.85	
b1	1.07	1.27	1.47	
C	0.40	0.50	0.60	
C1	2.70	2.80	2.90	
D	9.90	10.00	10.10	
E	28.00	-	28.60	
E1	15.50	15.60	15.70	
E2	12.30	12.40	12.50	
E3	9.15	9.20	9.25	
F	3.30	3.40	3.50	
G	3.10	3.20	3.30	
e	2.54 BSC			
L	12.40	-	13.00	
L1	3.46 BSC			

The AUK Corp. products are intended for the use as components in general electronic equipment (Office and communication equipment, measuring equipment, home appliance, etc.).

Please make sure that you consult with us before you use these AUK Corp. products in equipments which require high quality and / or reliability, and in equipments which could have major impact to the welfare of human life(atomic energy control, airplane, spaceship, transportation, combustion control, all types of safety device, etc.). AUK Corp. cannot accept liability to any damage which may occur in case these AUK Corp. products were used in the mentioned equipments without prior consultation with AUK Corp..

Specifications mentioned in this publication are subject to change without notice.