

## ULTRAFast RECOVERY POWER RECTIFIER

### Description

The SF5A200H is a silicon rectifier in a 2-Lead TO220 full-pack type package designed, and is specially suited for switching mode base drive and transistor circuit. This device is intended for use in low voltage, high frequency inverters, free-wheeling diode and polarity protection.

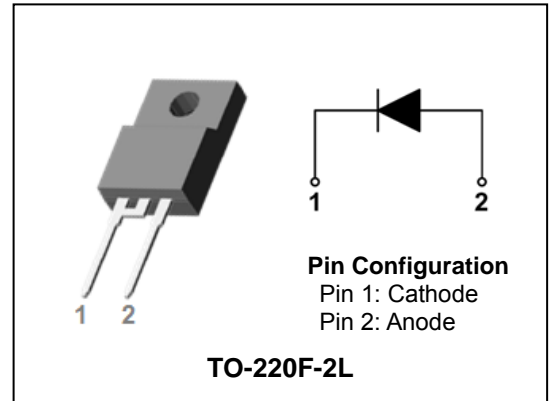

### Feature

- Low forward voltage drop and leakage current
- Ultra fast reverse recovery time
- Low power loss and High efficiency
- Full lead (Pb)-free and RoHS compliant device

### Product Characteristics

$I_{F(AV)}$	5A
$V_{RRM}$	200V
$V_{FM} @ T_j=125^\circ\text{C}$	0.83V
$t_{rr}$	30ns

### Applications

- Switching mode power supply
- Free-wheeling diode for motor application
- Polarity protection
- Power switching circuits

### Ordering Information

Device	Marking Code	Package	Packaging
SF5A200H	SF5A200H	TO-220F-2L	Tube

### Marking Information

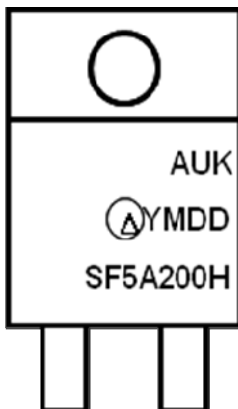

AUK = Manufacture Logo

$\Delta$  = Control Code of Manufacture

YMDD = Date Code Marking

- . Y = Year Code

- . M = Monthly Code

- . DD = Daily Code

SF5A200H = Specific Device Code

## Absolute Maximum Ratings (Limiting Values)

Characteristic	Symbol	Value	Unit
Maximum repetitive reverse voltage Maximum working peak reverse voltage Maximum DC blocking voltage	$V_{RRM}$ $V_{RWM}$ $V_R$	200	V
Maximum average forward rectified current	$I_{F(AV)}$	5	A
Peak forward surge current 8.3ms single half sine-wave superimposed on rated load (JEDEC Method)	$I_{FSM}$	60	A
Storage temperature range	$T_{stg}$	-45°C to +150°C	°C
Maximum operating junction temperature	$T_J$	150	°C

## Thermal Characteristics

Characteristic	Symbol	Value	Unit
Maximum thermal resistance junction to case	$R_{th(j-c)}$	4	°C/W

## Electrical Characteristics

Characteristic	Symbol	Test Condition	Min.	Typ.	Max.	Unit	
Peak forward voltage drop	$V_{FM}^{(1)}$	$I_{FM} = 5A$	$T_J = 25^\circ C$	-	-	0.98	V
			$T_J = 125^\circ C$	-	-	0.83	V
Reverse leakage current	$I_{RM}^{(1)}$	$V_R = V_{RRM}$	$T_J = 25^\circ C$	-	-	10	uA
			$T_J = 125^\circ C$	-	-	200	uA
Reverse recovery time	$t_{rr}$	$I_F = 1A, di/dt = -100 A/us$	-	-	30	ns	
Junction capacitance	$C_j$	$V_R = 5V_{DC}, f = 1MHz$	-	50	-	pF	

**Note :** (1) Pulse test :  $t_p \leq 380 \mu s$ , Duty cycle  $\leq 2\%$

## Electrical Characteristic Curves

**Fig.1  $I_F - V_F$**

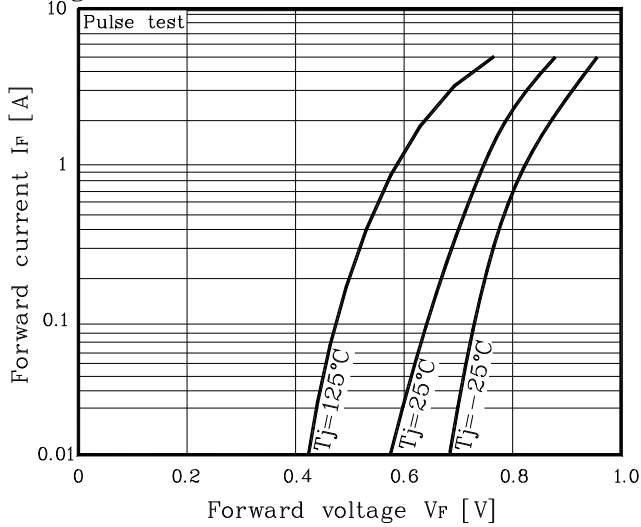

**Fig. 2  $I_R - V_R$**

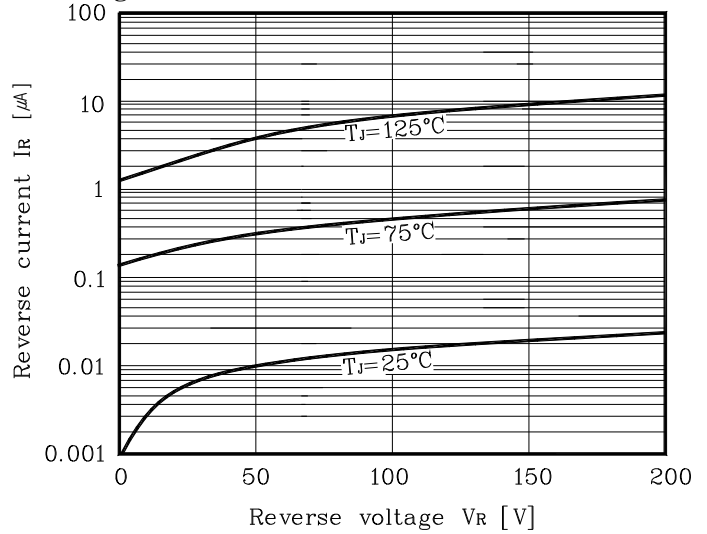

**Fig. 3  $P_F - I_O$**

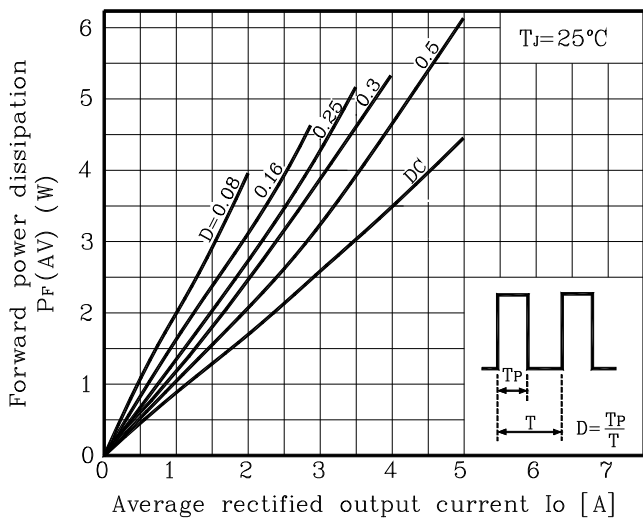

**Fig. 4  $C_T - V_R$**

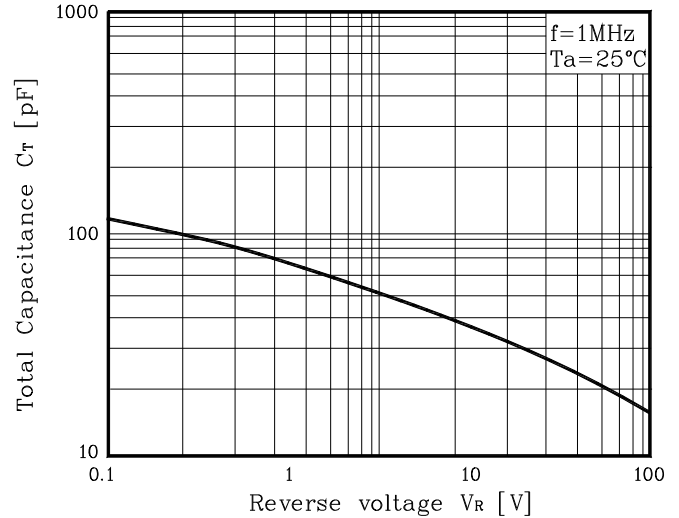

**Fig. 5  $I_{FSM} - \text{Number of cycle}$**

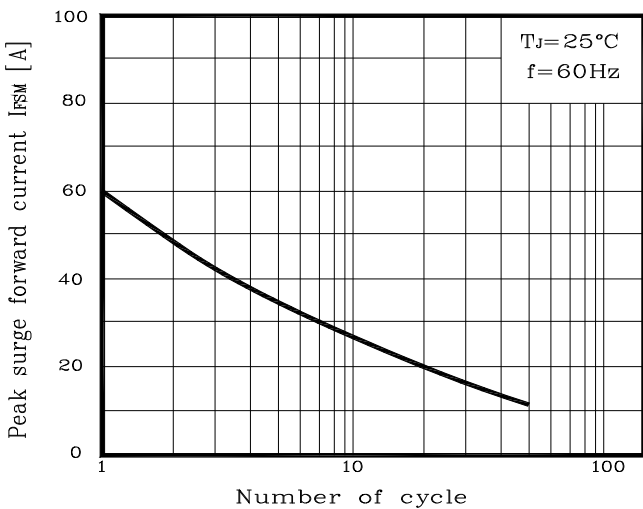

**Fig. 6  $I_O$  derating -  $T_C$**

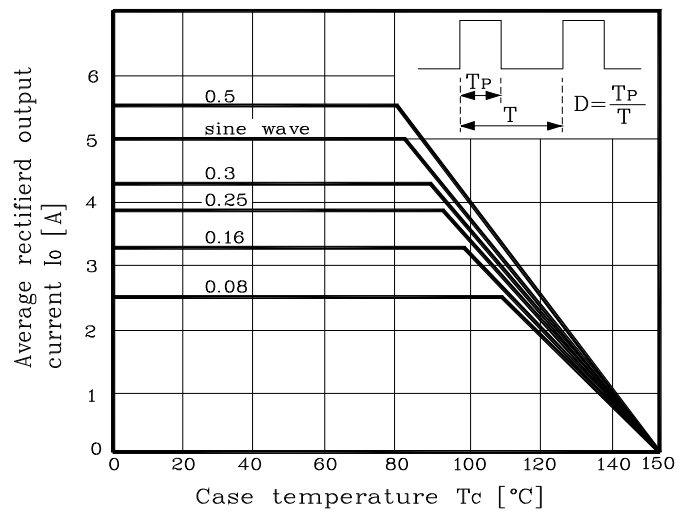

## Package Outline Dimension

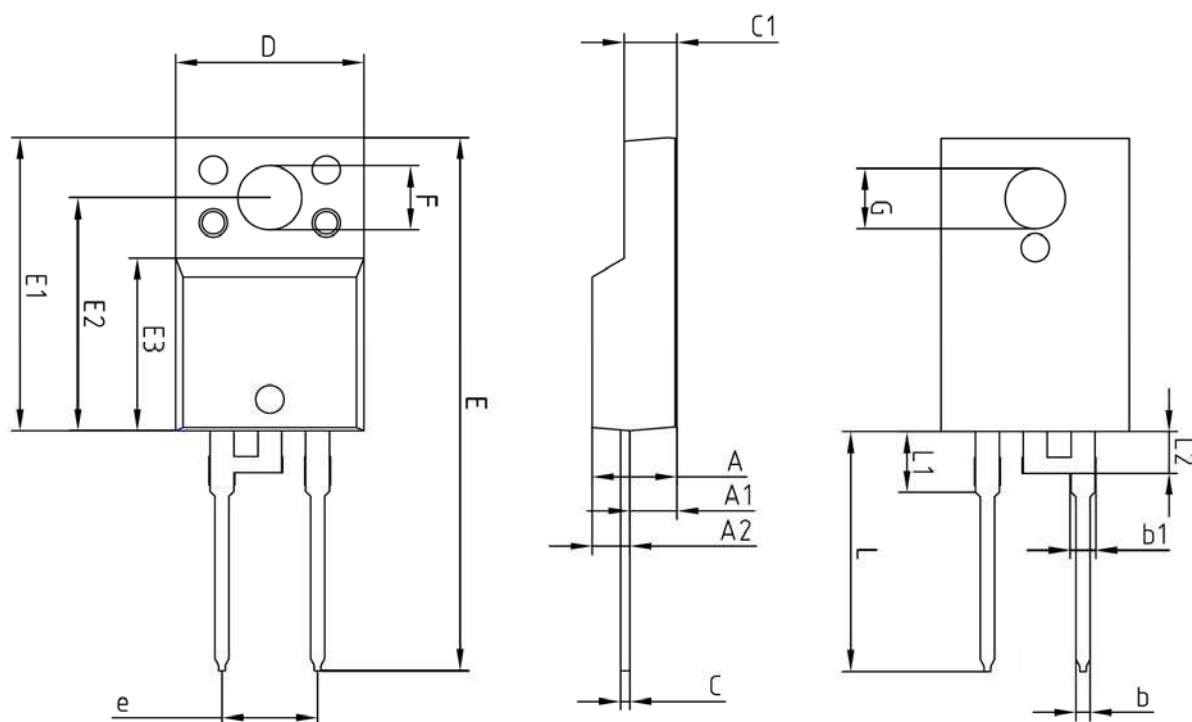

SYMBOL	MILLIMETERS			NOTE
	MINIMUM	NOMINAL	MAXIMUM	
A	—	—	4.60	
A1	2.45	2.50	2.55	
A2	1.95	2.00	2.05	
b	0.65	0.75	0.85	
b1	1.07	1.27	1.47	
C	0.40	0.50	0.60	
C1	2.70	2.80	2.90	
D	9.90	10.00	10.10	
E	28.00	—	28.60	
E1	15.50	15.60	15.70	
E2	12.30	12.40	12.50	
E3	9.15	9.20	9.25	
F	3.30	3.40	3.50	
G	3.10	3.20	3.30	
e	5.08 BSC			
L	12.40	—	13.00	
L1	3.46 BSC			
L2	2.21 BSC			

**The AUK Corp. products are intended for the use as components in general electronic equipment (Office and communication equipment, measuring equipment, home appliance, etc.).**

**Please make sure that you consult with us before you use these AUK Corp. products in equipments which require high quality and / or reliability, and in equipments which could have major impact to the welfare of human life(atomic energy control, airplane, spaceship, transportation, combustion control, all types of safety device, etc.). AUK Corp. cannot accept liability to any damage which may occur in case these AUK Corp. products were used in the mentioned equipments without prior consultation with AUK Corp..**

**Specifications mentioned in this publication are subject to change without notice.**